

*Presented to*

THE BILTMORE ROOM

HOWARD R. KRINBILD B.F.S. 1909

By .....

Date November 1957

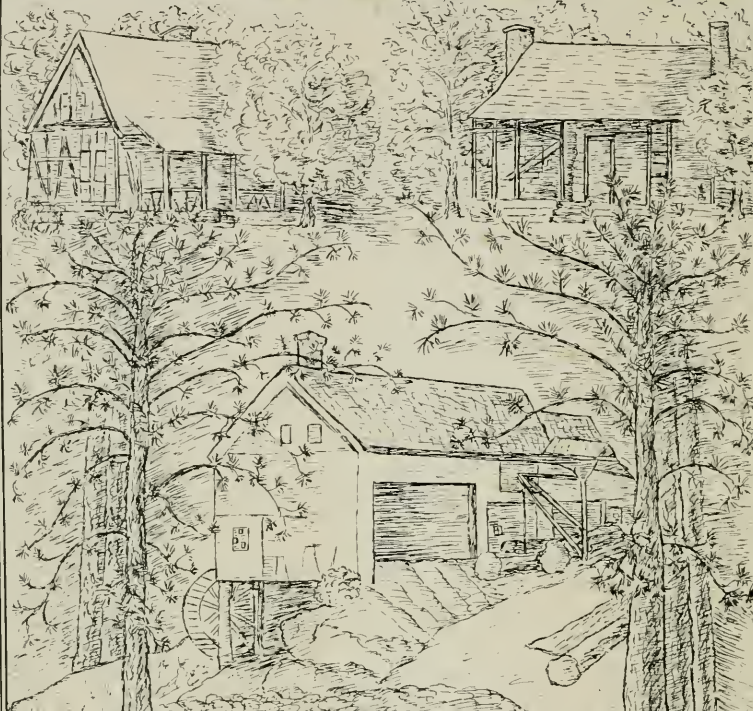

BILTMORE ROOM LIBRARY



Anna Graham L. Bridge, 1977

See Pages 271-272

143- Taper







A MANUAL  
FOR NORTHERN WOODSMEN



Digitized by the Internet Archive  
in 2009 with funding from  
NCSU Libraries

A MANUAL  
FOR  
NORTHERN WOODSMEN

BY

AUSTIN CARY

*Recently Assistant Professor of Forestry  
in Harvard University*



REVISED EDITION

CAMBRIDGE  
HARVARD UNIVERSITY PRESS

1918

FIRST EDITION

COPYRIGHT, 1909

By AUSTIN CARY

One thousand copies issued in January, 1909

One thousand copies issued in January, 1910

One thousand copies issued in July, 1911

Five hundred copies issued in August, 1915

REVISED EDITION

COPYRIGHT, 1918

By AUSTIN CARY

One thousand copies issued in January, 1918

## PREFACE

THE reception accorded this book since it was first issued in 1909, particularly the appreciation expressed by numerous woodsmen, has been gratifying. Letters of commendation have been received from users in all parts of the country. It is significant that the first typographical error discovered (a wrong figure in a logarithmic table) was pointed out by a ranger on the largest tract of unsurveyed timber land in the United States, in Idaho. The second correction was sent in by a Canadian cruiser.

The incidents just mentioned illustrate the wide distribution of the volume and explain the present extension of it. As originally written, the book did not aim at circulation west of the Lake states; but from the first a large part of the demand for it came from Westerners, chiefly those employed in the United States Forest Service. Revisions have been guided largely by this fact, and that is true especially of the present and first considerable revision, for aside from bringing the work up to date as concerns appliances and methods which have come into use since the first edition was written, the new matter and tables which have been introduced are mainly intended for the benefit of western woodsmen. As a result, material additions have been made under the heads Topographic Maps and Timber Estimating.

The book, however, is not materially increased in bulk, nor has there been any change in its chief purpose, which is to serve the men who are carrying the load of actual timber work in this country. To these men, in whatever section they are, and whatever may have been their training, the author extends greeting.

# CONTENTS

## PART I. LAND SURVEYING

	PAGE
SECTION I. THE SURVEYOR'S COMPASS	
1. The Instrument . . . . .	1
2. Adjustments of the Compass . . . . .	4
3. Keeping the Compass in Order . . . . .	6
SECTION II. THE MAGNETIC NEEDLE . . . . .	7
SECTION III. MEASUREMENT OF DISTANCE . . . . .	9
1. The Surveyor's Chain . . . . .	9
2. The Tape . . . . .	10
3. Marking Pins . . . . .	11
4. Chaining Practice . . . . .	11
5. Measuring Inaccessible Lines . . . . .	15
6. Stadia Measurement . . . . .	17
7. Units of Distance and Area . . . . .	19
SECTION IV. SURVEYING PRACTICE . . . . .	19
1. Running a Compass Line (Backsight, Picketing, Needle) . . . . .	20
2. Try-Lines . . . . .	22
3. Marking Lines and Corners . . . . .	23
4. Original Surveys and Resurveys . . . . .	26
5. Age of Spots or Blazes . . . . .	26
6. Notes . . . . .	28
7. Party and Cost . . . . .	28
SECTION V. COMPUTATION AND OFFICE WORK . . . . .	31
1. Traverse . . . . .	31
2. Area . . . . .	37
3. Plotting . . . . .	40
SECTION VI. ON THE BEARING OF LINES . . . . .	43
SECTION VII. ON OBTAINING THE MERIDIAN . . . . .	51
SECTION VIII. THE UNITED STATES PUBLIC LAND SURVEYS . . . . .	60

## PART II. FOREST MAPS

	PAGE
SECTION I. THE TRANSIT . . . . .	73
1. Adjustments . . . . .	73
2. Care of the Transit . . . . .	77
3. Stadia Measurement . . . . .	77
4. Uses of the Transit . . . . .	80
5. Summary . . . . .	87
SECTION II. THE LEVEL . . . . .	87
1. Adjustments . . . . .	88
2. Uses of the Level . . . . .	90
SECTION III. THE HAND LEVEL AND CLINOMETER . . . . .	93
SECTION IV. COMPASS AND PACING . . . . .	94
SECTION V. THE TRAVERSE BOARD . . . . .	98
SECTION VI. THE ANEROID BAROMETER . . . . .	103
SECTION VII. METHODS OF MAP MAKING . . . . .	113
1. Introductory . . . . .	113
2. Small Tracts . . . . .	117
3. Large Tracts . . . . .	121
A. With Land already subdivided . . . . .	121
B. Based on Survey of Roads or Streams . . . . .	121
C. Subdivision and Survey combined . . . . .	123
D. Western Topography. Use of Clinometer . . . . .	129
SECTION VIII. ADVANTAGES OF A MAP SYSTEM . . . . .	133

## PART III. LOG AND WOOD MEASUREMENT

SECTION I. CUBIC CONTENTS . . . . .	137
SECTION II. CORD WOOD RULE . . . . .	138
SECTION III. NEW HAMPSHIRE RULE . . . . .	138
SECTION IV. BOARD MEASURE . . . . .	139
1. General . . . . .	139
2. Scribner and Decimal Rules . . . . .	141
3. Spaulding or Columbia River Rule . . . . .	141
4. Doyle Rule . . . . .	141
5. Maine Rule . . . . .	142
6. New Brunswick Rule . . . . .	144
7. Quebec Rule . . . . .	145
8. Theory of Scale Rules and Clark's International Log Rule . . . . .	145
SECTION V. NEW YORK STANDARD RULE . . . . .	147
SECTION VI. SCALING PRACTICE . . . . .	148
SECTION VII. MILL TALLIES . . . . .	151
SECTION VIII. CORD MEASURE . . . . .	157

## PART IV. TIMBER ESTIMATING

	PAGE
SECTION I. INTRODUCTION . . . . .	161
SECTION II. INSTRUMENTAL HELPS . . . . .	162
SECTION III. HEIGHT MEASUREMENT . . . . .	165
SECTION IV. VOLUME TABLES AND TREE FORM . . . . .	167
SECTION V. PRACTICE OF TIMBER ESTIMATING . . . . .	173
A. Small and Valuable Tracts . . . . .	174
B. Larger and Less Valuable Tracts . . . . .	186
1. Type and Plot System . . . . .	187
2. The Strip System . . . . .	188
3. Line and Plot System . . . . .	192
C. Summary . . . . .	195
D. Pacific Coast Methods . . . . .	196

## PART V. TABLES

SECTION I. *Tables relating to Parts I and II*

1. STADIA REDUCTIONS . . . . .	211
2. SOLUTION OF TRIANGLES . . . . .	212
3. TRAVERSE TABLES . . . . .	214
4. LOGARITHMS OF NUMBERS . . . . .	220
5. LOGARITHMIC SINES, COSINES, TANGENTS, AND CO- TANGENTS . . . . .	222
6. SUPPLEMENTARY TABLES OF SMALL ANGLES . . . . .	228
7. NATURAL SINES AND COSINES . . . . .	230
8. NATURAL TANGENTS AND COTANGENTS . . . . .	232
9. SPECIMEN LETTERING . . . . .	234

SECTION II. *Tables relating to Parts III and IV*

1. VOLUMES OF CYLINDERS (LOGS) IN CUBIC FEET . . . . .	236
2. AREAS OF CIRCLES OR BASAL AREAS . . . . .	238
3. CORD WOOD RULE . . . . .	239
4. NEW HAMPSHIRE RULE . . . . .	240
5. NEW YORK STANDARD RULE . . . . .	242
6. SCRIBNER LOG RULE, LEGAL IN MINNESOTA . . . . .	243
7. DECIMAL RULE OF THE U. S. FOREST SERVICE . . . . .	244
8. DOYLE RULE . . . . .	246
9. MAINE LOG RULE . . . . .	248
10. QUEBEC RULE . . . . .	250
11. NEW BRUNSWICK RULE . . . . .	253

	PAGE
12. CLARK'S INTERNATIONAL RULE . . . . .	254
13. SPAULDING RULE OF COLUMBIA RIVER . . . . .	255
14. BRITISH COLUMBIA RULE . . . . .	258
15. VOLUME TABLES	
<i>A. Eastern</i>	
1. White Pine by the Scribner Rule . . . . .	261
2, 3. Red (Norway) Pine by the Scribner Rule . . . . .	262
4. White Pine as sawed in Massachusetts . . . . .	263
5. White Pine in Cords . . . . .	264
6. Spruce in Cubic Feet . . . . .	264
7. Spruce in Feet, Board Measure . . . . .	265
8. Spruce in Cords . . . . .	266
9. Hemlock by the Scribner Rule . . . . .	267
10. Hemlock as sawed in New Hampshire . . . . .	268
11. White (paper) Birch in Cords . . . . .	268
12. Red Oak as sawed in New Hampshire . . . . .	269
13. Peeled Poplar in Cords . . . . .	270
14. Second Growth Hard Woods in Cords . . . . .	270
15. Form Height Factors for Southern Hard Woods . . . . .	271
16, 17. Northern Hard Woods in Board Measure . . . . .	272, 273
18. Longleaf Pine in Board Measure . . . . .	274
19. Loblolly Pine by the Scribner Rule . . . . .	275
<i>B. Western; Notes on Western Volume Tables . . . . .</i>	<i>276</i>
20. Western White Pine in Board Feet . . . . .	281
21. Western Yellow Pine in Board Feet . . . . .	282
22. Western Yellow Pine (16-foot log lengths) . . . . .	283
23. Lodgepole Pine in Feet, Board Measure, and in Railroad Ties. . . . .	284
24. Western Larch in Board Measure . . . . .	285
25. Engelmann Spruce in Board Measure . . . . .	286
26. Douglas Fir of the Coast . . . . .	287
27. Douglas Fir of the Interior . . . . .	288
28. Washington Hemlock in Board Measure . . . . .	289
29. Washington Red Cedar in Board Measure . . . . .	290
30. California Sugar Pine in Board Measure . . . . .	292

### SECTION III. *Miscellaneous Tables and Information*

1. RULES FOR AREA AND VOLUME OF DIFFERENT FIGURES . . . . .	294
2. WEIGHT OF MATERIALS . . . . .	296
3. HANDY EQUIVALENTS . . . . .	297

	PAGE
4. NUMBER OF PLANTS PER ACRE WITH DIFFERENT SPACING . . . . .	297
5. COMPOUND INTEREST TABLE . . . . .	298
6. TIME IN WHICH A SUM WILL DOUBLE . . . . .	298
7. TABLE OF WAGES AT GIVEN RATES PER MONTH . .	299
8. THE BILTMORE STICK . . . . .	301



PART I  
LAND SURVEYING

## PART I. LAND SURVEYING

SECTION I. THE SURVEYOR'S COMPASS	
1. The Instrument . . . . .	1
2. Adjustments of the Compass . . . . .	4
3. Keeping the Compass in Order . . . . .	6
SECTION II. THE MAGNETIC NEEDLE . . . . .	7
SECTION III. MEASUREMENT OF DISTANCE . . . . .	9
1. The Surveyor's Chain . . . . .	9
2. The Tape . . . . .	10
3. Marking Pins . . . . .	11
4. Chaining Practice . . . . .	11
5. Measuring Inaccessible Lines . . . . .	15
6. Stadia Measurement . . . . .	17
7. Units of Distance and Area . . . . .	19
SECTION IV. SURVEYING PRACTICE . . . . .	19
1. Running a Compass Line (Backsight, Picketing, Needle) . . . . .	20
2. Try-Lines . . . . .	22
3. Marking Lines and Corners . . . . .	23
4. Original Surveys and Resurveys . . . . .	26
5. Age of Spots or Blazes . . . . .	26
6. Notes . . . . .	28
7. Party and Cost . . . . .	28
SECTION V. COMPUTATION AND OFFICE WORK . . . . .	31
1. Traverse . . . . .	31
2. Area . . . . .	37
3. Plotting . . . . .	40
SECTION VI. ON THE BEARING OF LINES . . . . .	43
SECTION VII. ON OBTAINING THE MERIDIAN . . . . .	51
SECTION VIII. THE UNITED STATES PUBLIC LAND SURVEYS . . . . .	60

# A MANUAL FOR NORTHERN WOODSMEN

## PART I. LAND SURVEYING

SURVEYING in forest land as compared with work done in towns and on farms is carried out under unfavorable circumstances. In the first place, timber and brush growth offer an obstruction to sighting; second, the work is often done far from a well supplied base; third, the limits of cost allowed are often the lowest practicable. These conditions have a strong effect upon the methods employed, and they also affect the choice of outfit. Equipment for such work should not usually be expensive, it should be as compact and portable as possible, and it should not be so delicate or so complicated as to be likely to get seriously out of order and so hold up a job.

### SECTION I

#### THE SURVEYOR'S COMPASS

**Compass and Chain** are the instruments that at present are most largely employed in forest land surveying, and there is little doubt that they will continue to be so employed. The compass is one of the mainstays of the practical woodsman. He should thoroughly understand its capacities and limitations, and should have perfect command of all parts of his own particular instrument.

##### 1. THE INSTRUMENT

The essential parts of the surveyor's compass are a **magnetic needle** for finding a meridian line, a horizontal graduated **circle** for laying off angles from this meridian, and **sights** attached for use in prolonging lines on the ground.

The needle in compasses used for surveying purposes is commonly between four and six inches in length. It rests by a jeweled bearing at its center upon a steel pivot screwed into the compass plate, and, turning freely in the horizontal plane, its ends traverse the graduated circle. The plane of the sights passes through the center of the circle, and cuts its circumference at two points marked N and S, known as the north and south points of the instrument. From these points the graduation of the circle runs  $90^\circ$  in each direction to the points marked E and W. These

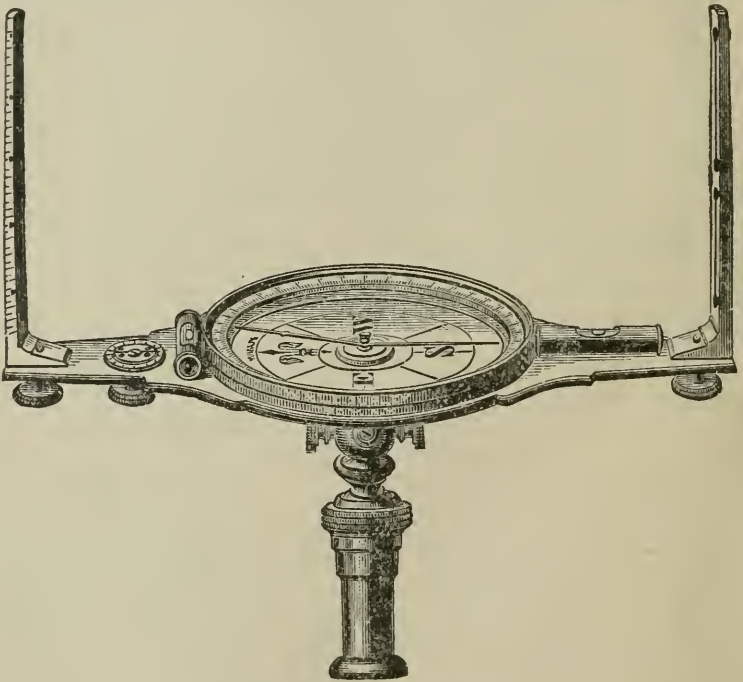

PLAIN SURVEYOR'S COMPASS

points on the face of the surveyor's compass are reversed from their natural position for convenience in reading bearings.

In using the compass, point the north end of the circle forward along the line and read from the north end of the needle.

A compass bearing is the direction from the observer at

the compass to any given object referred to the meridian. It is read as so many degrees from the N or S direction, up to  $90^\circ$ ; as, N  $10^\circ$  W, S  $88^\circ 15'$  E. The graduations on a surveyor's compass are commonly in half degrees, but it is usual, if necessary, to set by estimation quarter degree, or  $15'$ , courses. A bearing can be set, however, with a surveyor's compass in first-class order, to about  $5'$ .

A compass needle that is in good working order takes some little time to settle, and its condition may be told by the freedom and activity with which it moves. Time can be saved in setting it by checking its motion with the lifting screw. In its final settlement, however, it must be left free. For important bearings, it is well to let it settle two or more times independently.

A glass plate covers the compass box and two small levels placed at right angles to each other are used to set the instrument in the horizontal plane. It is very desirable that the box of a compass employed for woods work should be as nearly watertight as possible. In general make-up, the instrument is subject to considerable variation.

The plate of the **Plain Surveyor's Compass** is prolonged in the north and south direction into arms on which the sights are supported at a distance of twelve to sixteen inches apart. The actual sighting is done through fine vertical slits, and round apertures placed at intervals along these are convenient for finding objects and for getting the instrument approximately in line.

The **Vernier Compass** has the circle and the sights upon separate plates which may be turned on one another for  $20^\circ$  or more. Its advantage consists in the fact that declination, or a change in declination, may be set off, and the courses of an old survey set directly, or lines referred to the true rather than the magnetic meridian.

The **Folding-Sight Compass** possesses the advantages of light weight and the utmost compactness, and is therefore popular among woodsmen. The sights are set upon the edge of the compass box, and fold down across its face when not in use, the whole instrument with its mountings slipping into a leather case which may readily

be carried in the pack or slung from the shoulder. A folding-sight compass with too small a box and needle of less than full length should not be employed on work of importance, as it is impossible with such an instrument to read bearings and set marks with accuracy.

Compasses are either mounted on a tripod or fitted for attachment to a single staff called a Jacob-staff, which the surveyor may make for himself, when needed, from a straight sapling. The former is the firmer mounting and better adapted to accurate work, but the latter is much more portable, except on bare rocks is more quickly set up, and is generally employed for the ordinary work of the forest surveyor.

## 2. ADJUSTMENTS OF THE COMPASS

A compass in first-class order will meet the following tests:

- a. The plate must be perpendicular to the axis of the socket.
- b. The plane of the level bubbles must be perpendicular to the same axis.
- c. The point of the pivot must be in the center of the graduated circle.
- d. The needle must be straight.
- e. The sights must be perpendicular to the plane of the bubbles.

In these tests it is presupposed that the circle is accurately graduated and that the plane of the sights passes through the zero marks. These are matters that belong to the maker of instruments, and in all modern compasses accurate adjustment of them may be assumed.

The general principle of almost all instrumental adjustments is the **Principle of Reversion**, whereby the error is doubled and at the same time made more apparent. Thorough mastery of this principle will generally enable one to think out the proper method of adjusting all parts of any surveying instrument. In the case of the compass the above-named tests may be applied and the instrument adjusted as follows. The order of the adjustments is essential.

*a.* The plate is exactly vertical to the spindle in a new compass, but the soft metal of most instruments is liable in use to become bent. If that occurs to any considerable degree, it will be shown by the needle and the bubbles. The instrument should then be sent to the maker for repairs.

*b.* To make the plane of the level bubbles perpendicular to the axis of the socket, level the instrument, turn it  $180^\circ$ , and, if the bubbles are out, correct one half the movement of each by means of the adjusting-screw at the end of the bubble-case. Now level up again and revolve  $180^\circ$ , when the bubbles should remain in the center. If they do not, adjust for half the movement again and so continue until the bubbles remain in the center of their tubes for all positions of the plate.

*c, d.* When the pivot is in the center of the circle and the needle is straight, the two ends of the needle will cut the circle exactly  $180^\circ$  apart in whatever position the instrument may be set. If the needle does not so cut, one or both of these conditions is not fulfilled. If the difference between the two end readings is constant for all positions of the needle, then the pivot is in the center of the circle but the needle is bent. If the difference in readings is variable for different parts of the circle, then the pivot is off center and the needle may or may not be straight.

To adjust the pivot, first find the position of the needle which gives the maximum difference of end readings; then, using the small brass wrench commonly supplied with the compass, bend the pivot a little below the point at right angles to the direction of the needle until one half the difference in end readings is corrected. Repeat the test and adjust again if necessary. When the needle cuts opposite degrees, or when it fails to do that by a constant quantity in all parts of the circle, the pivot point is in the correct position.

With the above adjustment attended to, straighten the needle. To do this, set the north end of the needle on some graduation mark and bend the needle until the south end cuts the circle exactly  $180^\circ$  from it.

*e.* To make the sights perpendicular to the plane of the bubbles, level the instrument carefully, hang a plumb

line some feet away, and then look through the sights upon it. If the plumb line appears to traverse the forward slit exactly, that sight is in adjustment. If not, file off the base of the sight until the adjustment does come. Then revolve the compass  $180^\circ$  and test the other sight in the same manner.

### 3. KEEPING THE COMPASS IN ORDER

**Sharpening Pivot.** The pivot or center pin of a compass much in use is liable to become dulled so that the needle does not swing freely. To obviate this the needle should always be raised off the pivot when the compass is being carried. A much blunted pivot should be handed over to a jeweller to be turned down in a lathe, but ordinary sharpening can readily be accomplished by the surveyor himself with the aid of a fine whetstone and the small wrench usually supplied with a compass, or a pair of pliers. The pivot should be removed from the compass box and fixed in the end of a small, split stick; the point may then be sharpened by twirling it gently on the stone at an angle of about  $30^\circ$  with its surface. When the point is made so fine and sharp as to be invisible to the eye, it should be smoothed by rubbing it on the surface of a soft, clean piece of leather.

**Remagnetizing Needle.** Dulness of the needle may be due to the fact that it has lost its magnetism and needs to be recharged. For this purpose a permanent magnet is required. The north end of the needle should be passed several times along that pole of the magnet which attracts it, and the south end passed similarly over the opposite pole. The passes should be made from center to end of the needle, and a circle described in bringing the two ends successively into contact. In order to prevent the loss of magnetism, the needle of a compass not in use for a considerable time should lie in the north and south direction.

**Balancing Needle.** The needle is commonly balanced on the pivot by a fine brass wire wound around the south end. If change of latitude is made, the balance will be destroyed, and the wire may be shifted to make adjustment.

**Replacing Glass.** In case of emergency, a piece of win-

dow glass may be cut down with a diamond and ground on a grindstone to fit its setting. It may then be set in place, with putty if possible, and the binding ring sprung into place over it.

## SECTION II

### THE MAGNETIC NEEDLE

All compass surveying is based on the tendency of the magnetic needle to point north and south. The direction of the needle, however, is very far from being constant.

**Secular Change.** There is a belt of country crossing the United States in a general north and south direction through the states of Michigan, Ohio, and South Carolina along which the needle at the present time points due north toward the earth's pole. This belt is called the **agonic line, or line of no variation**. East of this line the needle points westward of true north; west of this line it points to the eastward of it. The direction from any place toward the pole of the earth's revolution is for that place the **true meridian**. The direction taken by the needle is the **magnetic meridian**. The angle between the two is called the **declination of the needle**, west if the needle points west of true north, east if the needle points east of it. The declination is greater the farther the agonic line is departed from, amounting to more than  $20^{\circ}$  in the maritime provinces and the Puget Sound country. The agonic line is not stationary but is moving slowly westward, as it seems to have done constantly since the beginning of the last century. The declination of the needle, therefore, is changing from year to year and at a different rate in different parts of the country.

These facts affect the work of the land surveyor importantly, and sections on the bearing of lines and on ascertaining the true meridian are given later on in this volume.

**Daily Change.** The needle when free and undisturbed swings back and forth each day through an arc amounting commonly in the United States to about  $10'$ . Early in the morning, from four to six o'clock according to the season,

the north end of the needle begins to swing to the east, reaching its maximum position between eight and ten o'clock in the forenoon. It then swings west to a maximum westerly position reached from one to two o'clock P. M. Then it swings slowly east again to a mean position reached between six and eight P. M., at which point it remains practically steady during the night.

The effect of this variation is such that if a surveyor starts a line in the morning and runs one course all day, he runs, not a straight line, but a long curve. This variation, however, like the slight variation that occurs during the course of the year, is in woods work commonly disregarded.

**Irregular Changes.** The needle is subject occasionally to sudden and irregular changes in direction. They sometimes occur during thunder storms, and at other times are attributed to so-called magnetic storms, related perhaps to the *aurora borealis*. Trouble from this source is not often experienced by the surveyor, but it is a matter which needs to be understood and watched for.

**Local Attractions.** All users of the compass are on guard against the disturbance caused by iron in its vicinity, in the form, for instance, of chains, axes, and steel rails. In addition, there are in most countries regions of greater or less extent where the needle is subject to irregularities. These are due to iron ore or other magnetic material located in the vicinity, or to unknown causes.

A local disturbance is indicated when the compass does not read the same on the two ends of a line, and in compass running error from this source is guarded against by keeping careful watch of the backsight. Local disturbances vary much in intensity. When very strong, they are readily detected, and if confined in area present little difficulty to the surveyor, who will clear out his line across them with especial care, and either picket<sup>1</sup> through or set the compass by backsight. Slight disturbances are harder to detect. If the area of disturbance is large, particularly if the ground is broken, the compass cannot be depended on to carry a line through with accuracy, and a transit or solar instrument must be used.

<sup>1</sup> See page 21.



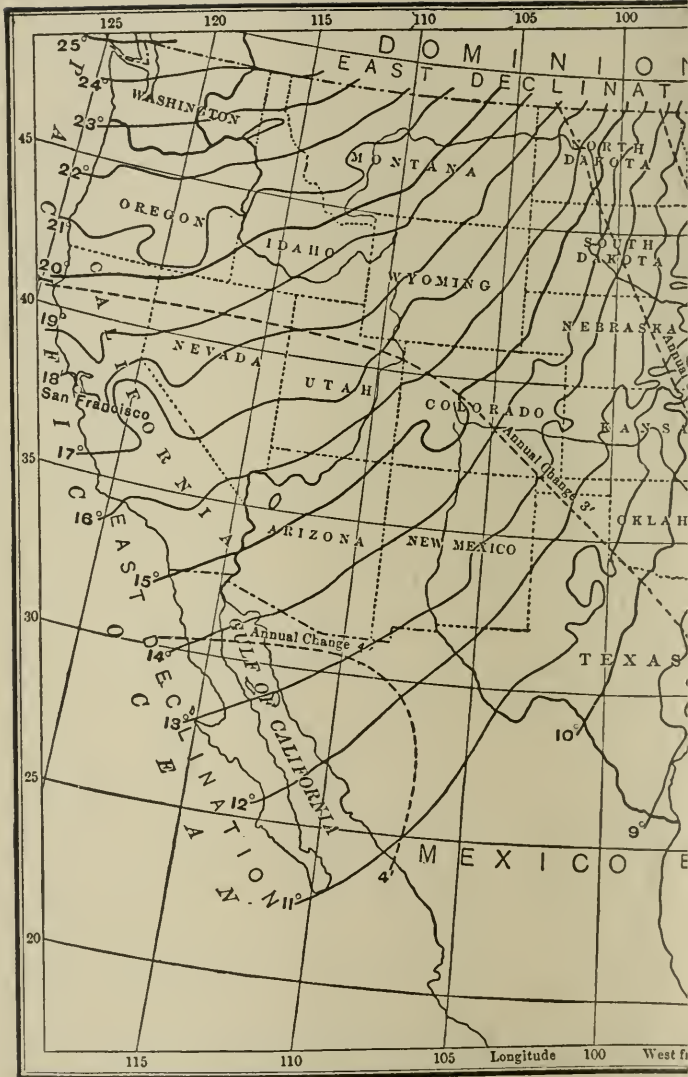

LINES OF EQUAL MAGNETIC DECLINATION AND OF EQUAL ANNUAL MAGNETIC CHANGE IN THE  
United States Coast



ANNUAL CHANGE IN THE UNITED STATES FOR 1915. (From Report of the Geodetic Survey.)



**Electricity.** A little caution is necessary in handling the compass in order that the glass cover shall not be electrified by the friction of cloth or the hand, so as to attract the needle to its under surface. If, however, the glass does become electric, the trouble may be removed by breathing upon it, or by touching different parts of its surface with the moistened finger.

**Difference in Instruments.** It is a well-known fact that different instruments do not always give the same bearing when read on the same marks at the same time. A difference of 15' is not uncommon.

**Summary.** The magnetic needle is thus seen to be subject to numerous variations and irregularities, and on that account work with the needle compass cannot be expected to give the most accurate results. The instrument has great advantages, however, and a very large field of legitimate use. It gives an approximately true direction from a detached point. Except on open ground, it furnishes the quickest and cheapest means of turning an angle or prolonging a line. Most authoritative land surveys have been made with the needle compass and their renewal is best accomplished by use of the same instrument. The special advantages of the compass in forest conditions and its most effective use therein are discussed under the head of SURVEYING PRACTICE.

### SECTION III

#### MEASUREMENT OF DISTANCE

##### 1. THE SURVEYOR'S CHAIN

The word "chain" in connection with land surveying is used to represent two things: a distance of 4 rods or 66 feet, and an instrument for measuring distance. The chain in use for general land surveying is 66 feet long and divided into 100 links, but woodsmen working in rough ground find the 33 foot or half chain with 50 links much more convenient.

A chain for surveying purposes should be made of steel wire, and its links should be brazed to prevent stretching

by opening of the joints. Chains have every tenth link marked by a brass tag, and these tags have one, two, three, etc., teeth, so that the number of links may be readily and accurately counted.

Chains change in length by use. The links may be bent and the chain thus shortened, a matter which can readily be adjusted by hammering; but more commonly a chain increases in length from flattening of the links and wear in the numerous joints. This may be corrected to a limited extent by turning up the nuts which hold the handles. Further effect may be had by taking out one or more of the rings which connect the links, or better still, by hammering each link while it is held in a vise, and so distributing the correction.

The chain is so liable to change in length that provision should be made for testing it frequently. An unused tape, known to be of true length, kept at home or only taken off on long jobs, is the best and most convenient safeguard.

## 2. THE TAPE

Steel tapes are in wide use for general surveying, but not usually among woodsmen because of their liability to breakage. They have, however, distinct advantages. They are light, so as to be leveled readily when measurement is being made on a slope. They do not stretch. There are no links to get kinked and so cause a false measure. A tape for field use should be made of steel ribbon from  $\frac{1}{8}$  to  $\frac{1}{4}$  inch wide and No. 30 to 32 thick. Wider and thinner tapes are a nuisance in woods conditions.

Tapes are made of any length and graduated to suit the work for which they are designed. One 66 or 33 feet long, graduated to links, will best suit the needs of the timber land surveyor.

Some precaution must be taken with steel tapes. When in use, they should be kept out at full length and never be doubled on themselves, for, if doubled, they are easily kinked and broken. When done up, they should be wiped clean and dry, and so cared for as to prevent rusting. A

broken tape can generally be repaired on the ground if there are at hand a punch, a piece of another tape, and some pins to serve as rivets.

### 3. MARKING PINS

Woodsmen frequently manufacture their own marking pins of wood or wire. Those bought from dealers are made of heavy iron wire, are some fifteen inches in length, with one end sharpened and a ring turned in the other for convenience in handling. Strips of cloth are tied in the rings, so that they can be readily seen. It is most convenient to use eleven pins in chaining. One of them is stuck at the starting point, the leading man takes ten, and thus there is always one in the ground to start from when the tallies are finished.

### 4. CHAINING PRACTICE

Chains are standardized in length at about ten pounds pull with their full length supported. In woods work it is generally necessary that the chain should be suspended above the ground and not lie upon its surface. Care must be taken, therefore, in accurate measurement, to give it **proper tension**. What tension is proper for a suspended chain, — in other words, what sag should be allowed to compensate for the stretch of the chain under the greater tension — may be determined on perfectly smooth and level ground, and this is a valuable exercise for inexperienced chainmen.

In order to get true chainage between points, the chain should be kept **straight and free from kinks**. It must also be kept in approximately true alignment, though a constant error of  $1^\circ$  in that matter, equivalent to seven inches error in setting pins each two rods of distance, shortens the line by only nine and a half inches in the mile. Similarly, the chain **must be levelled** so as to give distance in a horizontal line, not following the contour of the ground. In this last connection, that is, in getting distance correctly on slopes and over rough ground, are met the greatest difficulties in practical chaining. What is necessary is first, to determine when the chain is level, and second, to

carry the point occupied by the suspended end of the chain vertically down to or up from the mark on the ground.

The use of plumb lines and plumbing rods for this purpose is well known from standard works on surveying. It is common woods practice to drop a pin from the head end of the chain, and that practice, when a pin loaded near the lower end is used, has been approved for United States land surveys. Only one such pin is required in a set, as after it is stuck in the ground another may be substituted for it. Similarly, for the rear end of the chain, when it has to be held above the ground, an ax held suspended beneath the handle, with the bit turned across the line, enables one to do quick and fairly accurate plumbing. For determining when the chain is level, a hand level or Abney clinometer, such as is shown on page 93, may well be put in the hands of the men. There is a strong tendency on the part of unpracticed chainmen to hold the down-hill end of the chain too low.

It is to be observed that all the above-mentioned sources of error work in one direction, namely, to give too large a valuation to the distance between two points. The young, school-trained man particularly, with his aspiration after exactness, is apt to undervalue these sources of error, and, in consequence, not give land enough.

In view of all the facts and conditions, particularly because of the pressure for cheapness in this class of work, many practical woods surveyors have concluded that it is best and safest not to strive after too great mechanical exactness, but to make a small constant **allowance** at the rear end of the chain. On the other hand, the loose practices of some old woodsmen, such as letting the chain run out the length of a man's arm beyond the mark, have nothing to be said in their defense.

**The general method of procedure in chaining**, to be modified as circumstances may require, is as follows. The two chainmen will be spoken of as head and rear man. Commonly, the rear man is the better and more experienced of the two, and is in general charge.

With one pin set at the starting point, the head man takes his end of the chain or tape and ten pins and steps

off in the direction of the line to be measured. Just before the chain is all drawn out the rear man calls out "chain" or "halt," and prepares to hold his end of the chain on the mark. The rear man lines in the other, by the compass ahead, by stakes left, or by the marks and bushing

TABLE SHOWING ERROR CAUSED BY CHAINING ALONG GROUND OF DIFFERENT DEGREES OF SLOPE

Slope.		Error.	
In feet per 100.	In degrees.	In feet per mile.	In links per chain.
2	$1\frac{1}{8}$	1.0	.02
4	$2\frac{1}{2}$	4.3	.1
6	$3\frac{3}{4}$	9.5	.2
8	$4\frac{1}{2}$	16.7	.3
9	$5\frac{1}{4}$	21.2	.4
10	$5\frac{3}{4}$	26.1	.5

along the line. Kinks are shaken out, the chain is levelled, and proper tension is applied. When all is ready and the rear man has his handle firmly held on the mark, he calls out "stick" to the leader who sets his pin at once and calls "stuck." When the rear man hears this signal, *and not before*, he pulls his pin and both men move quickly forward, repeating the operation till the head man has stuck his last pin or has reached the end of the line. When the head man has stuck his last pin he calls "tally." The rear man then drops his end of the chain, counts the pins to make sure that none has been lost, and, going forward, gives them to the head man who counts them again. The tally is marked down and a stake left at the point for reference in case of a lost pin or other cause of debate in the next tally. Pins should be set plumb, and, in general surveying practice, the point held to is the point at which they enter the ground. In the brush and "down stuff" of some woods lines, however, it is sometimes neces-

sary to chain by the top, not the bottom, of the pins. No jerking of the chain should be allowed. The rear man should not stop the head man with a jerk. The head man must pull steadily on the chain when measuring.

When chaining on slopes which are so steep that the full length of the chain cannot be levelled at once, the head man first draws the chain forward the whole length and in line. He then drops the chain and his marking pins and returns to a point where he can level a part of the chain. This distance is measured and one of the rear man's pins stuck at the point. The rear man then comes forward and, taking the chain at the same point, holds it to the mark while a second section is measured, and so on till the end of the chain is reached, when the head man sticks one of his own pins. It is not usually necessary to note the lengths of the parts of the chain measured. Take care only to measure to and from the same points in the chain and not to lose the count by getting the marking-pins of the two men mixed together.

**Accuracy.** The requirements of woods chainage vary so widely, its difficulties are sometimes so great, and the expense permissible for the work is often so restricted that only guarded statements can be made as to obtainable accuracy. When chainmen, measuring the same line twice, agree almost exactly, it does not prove that they have given correct chainage, for two other men on the same line may get a result considerably variant. Really correct chainage is to be obtained only by strict attention to the sources of error mentioned above, their amount and nature. In general, it may be said that on smooth and level ground, free from obstructions, chaining may be done with error of a very few feet in the mile. On land as it runs, however, chainage accurate to within a rod in a mile is generally called entirely satisfactory.

**Summary.** Good chaining consists in keeping the chain of right length, in true alignment, vertical and horizontal, and in proper stretching, marking, and scoring. It is a very important part of all surveying which employs that method of measuring distance, and has been badly neglected in much woods work of the past. It needs and de-

serves good men to carry it on, men who will get down to the ground and take all needed pains in marking, leveling, and alignment. They should be brisk men, moving quickly and doing their work in a prompt and business-like manner. Much, too, depends on system, — on tallying, passing pins, etc., from habit and in regular order. Some men never will make good chainmen because they will not take sufficient pains about details. A few in their strict attention to these are liable to make gross blunders. The man in general charge of surveying work must give careful attention to this part of the business. Chainmen must be trained in good methods and watched till they are perfectly trustworthy, while careful consideration must be given to sources of error and to possible improvements in method.

### 5. MEASURING INACCESSIBLE LINES

Ponds, bogs, and bluffs, over which it is impossible to chain, are met in the practice of nearly every surveyor, and quick and accurate measurement across them constitutes one of the problems which he has frequently to solve. Each problem of that kind has to be solved in the field according to the ground and circumstances. The methods commonly employed in such cases are as follows:

1. **Offset.** Frequently a short offset squarely to left or right will clear the obstacle.

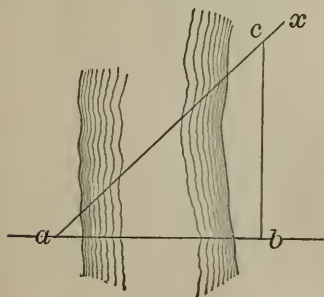

FIG. A

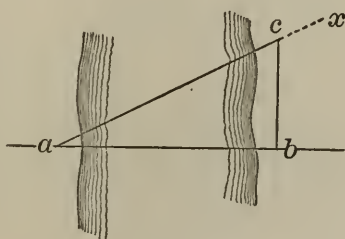

FIG. B

2. **Method by 45° Angle.** (A) With the compass at  $a$ , set a stake in the line at  $b$  across the obstruction, and, turning off an angle of 45°, set another stake on that range

as  $x$ . Set up at  $b$  and, turning off a right angle, set a stake  $c$  in the range  $a x$ . Then  $a b = b c$ .

3. **Method by  $26^{\circ} 34'$  Angle.** (B) Proceed as before, making the angle  $b a c = 26^{\circ} 34'$ ; then  $a b = 2 b c$ , as may be found in the table of tangents.

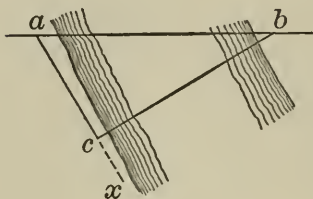

FIG. C

4. **Method by  $30^{\circ}$  Angle.** (C) With compass at  $a$  set a stake in line at  $b$ , and, turning off an angle of  $60^{\circ}$ , set another stake on that range, as  $x$ . Set up at  $b$  and turn off  $a b c = 30^{\circ}$ , setting a stake  $c$  in the range  $a x$ . Then  $a b = 2 a c$ .

5. **Method by Tangents.** (D) With the compass at  $a$  set a stake at  $b$ , also run out a perpendicular line and set a stake at  $c$  visible from  $b$  at any convenient distance. Measure  $a c$ . With the compass at  $b$ , take the bearing of  $c b$  and thus get the angle  $a b c$ . In the table of tangents

look up the tangent of this angle. Then  $a b = \frac{a c}{\tan a b c}$ .

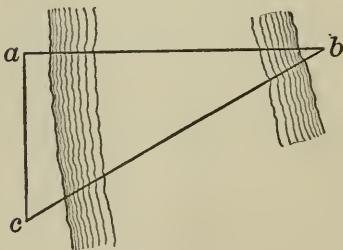

FIG. D

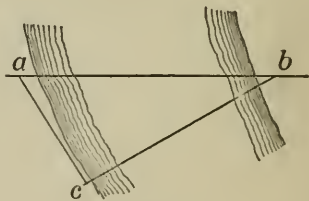

FIG. E

6. **Method by Oblique Triangle.** (E) The stake  $c$  may be set at any convenient point visible from both  $a$  and  $b$  and the angles at  $a$  and  $b$  measured. Measure also the side  $a c$  or  $b c$ , whichever is easier. Then  $a b$  may be computed as the side of an oblique triangle. For formulas necessary, see pages 212-213.

7. **Method by Traverse.** (F) In the case of a large lake or stream, several courses may be run along its banks, and when the range of the line is again struck, as at  $e$ , the dis-

tance  $ae$  may be computed by traverse. If  $ae$  runs N and S, the distance  $ae$  will be the latitude of the traverse, or, stated in other words, it will be the sum of the products of the cosines of the several courses into their respective distances. The departure of such a traverse should be zero. Thus, if  $e$  is not visible from  $a$ , or if it is not convenient to take the range  $ae$ ,  $e$  may be set when the sum of the departures figures up 0. This process of surveying a lake or river shore is called "meandering." It is the method pursued in the United States land surveys on considerable bodies of water. The same method may also be employed to get round a precipitous hill or some other inaccessible object.

An example of the computation necessary for solving a problem of this kind is given on page 33.

8. **Method by  $60^\circ$  Angles.** (G) A precipitous bluff or impassable swamp may occasionally be passed most readily in the following manner. With the compass at  $a$ , lay off a  $60^\circ$  angle and run out  $ac$ , carefully chaining. Next, making an angle of  $60^\circ$  at  $c$ , run out  $cb$  to an equal distance. Then, if the work has been done accurately,  $b$  is in the line and  $ab = ac = bc$ .

In working by any of these methods it is better, if possible, to set  $b$  in range by the compass from  $a$  rather than to rely for the range on any process of figuring or angulation.

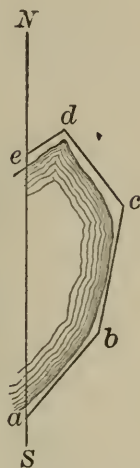

FIG. F

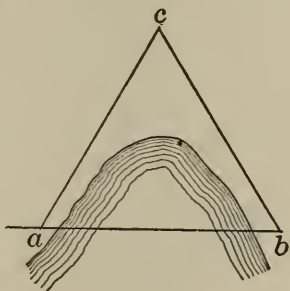

FIG. G

## 6. STADIA MEASUREMENT

A substitute for chaining, which has to some extent been employed in forest land surveying and which deserves

wider use, is stadia measurement, or the measurement of distance by wires placed in the focus of a telescope and the space which they cut off on a graduated rod. The principles of this method are stated on page 77.

For this purpose a light telescope may be fitted to the rear sight of the compass, as shown in the illustration,

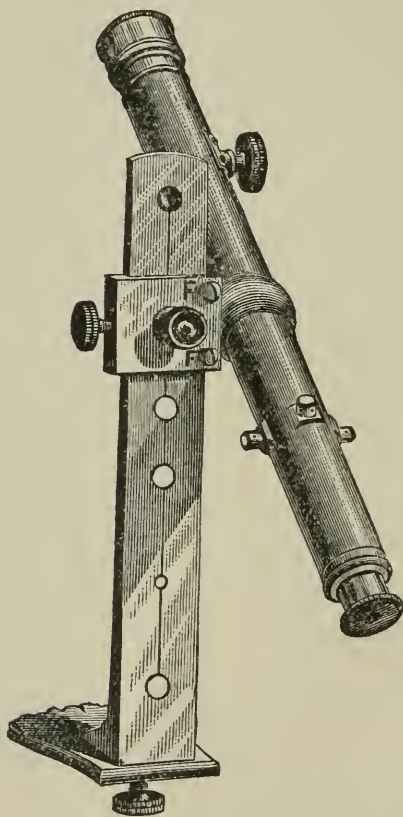

A TELESCOPIC SIGHT

a level and vertical circle being added if the instrument is to be used on rough ground. The cost of such an instrument complete is about the same as that of a compass. Its adjustments will readily be understood from its construction and from consideration of the adjustments required for the transit.

The advantages of this instrument in land surveying are as follows:—

1. Sights may be taken on steeper ground, either up or down hill, than can be covered through compass sights.

2. Distances over very steep ground can be measured more accurately and quickly than by use of the chain.

3. Distance across gorges, swamps, and bodies of water can be obtained directly and with ease.

4. It enables the surveyor himself to perform all the particular work on a survey, and this on short jobs, or wherever reliable chainmen cannot be had, may be a very great advantage.

Stadia wires in an instrument used for land surveying

should be so spaced that one foot on the rod will be cut off when it is held at a distance of 66 feet, or, if the wires are fixed, the rod may be graduated to correspond. For occasional use in land surveying, the rod may best be made of painted canvas, which, in case of need, may be tacked on any pole that comes to hand.

The **Stadia Hand Level** is a simpler form of the instrument, adapted to the measurement of the width of gorges or ponds. It is readily carried in the pack, and, when in use, may be held in the hand or mounted on a staff. The ready range of this instrument is 200–300 feet.

#### 7. UNITS OF DISTANCE AND AREA

7.92 inches = 1 link.

25 links = 1 rod.

100 links = 66 feet = 1 chain.

320 rods = 80 chains = 1 mile.

160 square rods = 10 square chains = 1 acre.

640 acres = 1 square mile or section.

The *vara*, a measure of Spanish origin, prevails in California and in Texas. The California *vara* is 33 inches. The Texas *vara* is  $33\frac{1}{3}$  inches, and 5645.376 square *varas* make one acre.

In Louisiana and the Province of Quebec, the *arpent*, an old French unit, is the measure of areas. This is .8449 acre.

The hectare = 10,000 square meters (meter = 39.37 inches) or 2.47 acres. This is also a French measure.

### SECTION IV

#### SURVEYING PRACTICE

The **starting point** of a survey is generally settled for a surveyor by outside controlling circumstances. When this is recognized, the next thing to do may be to find out what **course to run** by an observation for the true meridian, or by finding the bearing of an old line. With the starting point and course determined, the method of procedure is about as follows.

## 1. RUNNING A COMPASS LINE

Set up the compass at the point from which the line is to start; level the plate; free the needle, and when it has settled, set the course to be run. It is desirable on starting a line to let the needle settle two or more times independently.

An assistant, called the rodman or flagman, then goes ahead with a pointed rod or flag, and, following him, go the axemen, clearing out the bushes and other obstructions in such a manner as to secure both a clear line of sight and a path for the chain. The rodman may use an axe. He guides himself at first by the compass sights, later by signals from the compassman or by the range of the line. The axemen guide their work by him.

When the rodman has gone ahead a convenient distance, at signal from the compassman or acting on his own judgment, he selects a spot for a second setting of the compass, attention being paid both to firm setting and clear ground for the instrument, and to facility in getting sight ahead. On uneven ground summits commonly meet best this last requirement.

When setting the rod, the rodman should face the compass, holding the rod plumb and directly in front of him. He sticks it as directed by the compassman, who assures himself at the time that everything about the instrument is right. Before taking up the compass, the man in charge of it sets a stake near by and in line to be used in backsight. The needle is then lifted, and the compass taken up and carried forward to be set up at the point marked by the rodman. If a Jacob-staff is used instead of a tripod, the compass should be set up ahead of the rod with its center in line, the exact position of the foot of the staff being of no consequence.

The compass is then levelled again with its N mark ahead as before and the sights turned on the object left at the starting point. The needle is then freed, and if, when it settles, the bearing reads the same as before, the surveyor is assured that there is no local disturbance, and may proceed confidently. The rod and axemen soon learn

to range for themselves, and lose no time waiting for the set-up of the instrument. The chainmen keep behind the instrument where they are out of the way. Each man learns his exact duties, and all hands, particularly the compassman and rodman, learn to work together.

**Running by Backsight.** The details of compass surveying vary considerably in accordance with the accuracy required, cost allowed, and the make-up of the party doing the work. If local attraction is suspected or, on short lines, if great accuracy is required, obstructions are cleared completely out of the line, and when an assumed or trial course has been started, it is prolonged by backsight entirely, reference to the needle not necessarily being made. In order to do this, either a rear rodman is employed or a stake is set in line at each station occupied by the compass.

**Picketing.** The compass after the start, indeed, may not be used at all, but straight stakes, preferably four to five feet high and sharpened at both ends, may be ranged in one after another along the line. This method of running a line is frequently resorted to, and is called picketing.

To clear out in most woods a line open enough for continuous backsighting or picketing is an expensive process, and, further, this method for long distances and uneven ground is not to be relied on. If, in those circumstances, close accuracy of alignment must still be had, resort must be made to another class of instrument, a transit or solar, which may carry the work out of the hands of the woods surveyor.

**Running by the Needle.** Usually the compass will do the work reasonably well and satisfactorily to all interested parties, in which case the needle will be used at nearly every setting. In all compass running it is well to carry a light rod ahead, though that is sometimes dispensed with, the compassman going up to a stake or even an axe set up by the head axeman in line. When trees of some size are run into, they are not commonly cut down, but the compassman notes, or has marked, the spot at which his line of sight hits them, and, going forward, sets up beyond them in the same range as nearly as he can. For backsighting it is not a great trouble to set stakes, but, in a

country where local attraction is infrequent it is sufficient precaution to watch the blazes and bushing back along the line. In any case, time is saved by setting up the compass approximately by the backsight before letting the needle go free.

## 2. TRY-LINES

When two unconnected points are to be joined, it is usual first to run a line without spotting, a try-line so called, and if the desired point is not hit, to measure at right angles the distance between the line run and the point aimed at, figure the angle of error, and rerun the line. The angle required is obtained from a table of tangents.

Thus suppose a try-line to have been run N 4° E 120 rods or 30 chains and to have hit 32 links east of the mark aimed at. Dividing 32 by 3000 (the distance run in links) gives .0107, and the angle of which this is tangent is found in the table of natural tangents to be 37'. The compass may therefore be set N 3° 23' E, and the line rerun.

Results near enough for most purposes may be had by remembering that the tangent of 1° is .0175 (*i. e.*, 1 $\frac{3}{4}$  feet in 100, or 1 $\frac{3}{4}$  links per chain) and that the tangents of small angles are in proportion to the size of the angles. Thus with the case above, the tangent of 1° being .0175 and that of the angle required .0107, .0107 divided by .0175 equals .61 of 1°, or 37'.

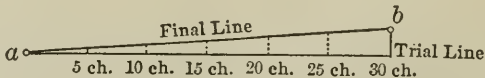

DIAGRAM SHOWING THE METHOD BY OFFSET

Or instead of using the compass to rerun the line, its position may be fixed by **offset**, that is, by measuring at right angles to the try-line, at different points along it, the distance required to place points in the desired range. For this purpose stakes should be left in the try-line at equal distances apart, say every 5 chains, and the length of each offset may be figured by tangents or as a simple problem in proportion.

Thus with the case in hand. The tangent of the angle between the try-line and the true line has been figured as .0107. This decimal multiplied by five chains or 500 links gives  $5\frac{1}{3}$  links, the offset from the 5-chain point. Similarly 10 chains multiplied by .0107 gives 10.7 links, and so on until all the offsets have been computed.

By proportion the problem is even simpler. In the case in hand the offset at the 15-chain mark should evidently be half that at the finish, or 16 links. At the 5-chain mark it is  $\frac{1}{6}$  of it, or  $5\frac{1}{3}$  links as found before. In the same way offsets for any length of line and any error in closing may be figured. When the points have been put in, the line may be blazed through by eye, or with the aid of the compass.

### 3. MARKING LINES AND CORNERS

**Corners.** Permanent corner marks are especially valuable in maintaining bounds and protecting property rights; and the desirability of stone monuments, or, failing these, of earth mounds, iron rods, or charcoal, is not to be disputed. Forest land is occasionally subject to great mischances, as from clean cutting, wind, and fire, and marks which can survive these have distinct and peculiar value.

On the other hand, posts of durable wood, and trees that are likely to remain in place a long time are generally handiest, are easy to mark on, and frequently meet, better than more elaborate and expensive marks, the ideas of owners and the customs of the country. Supplemented by blazed and marked witness trees, such markings for corners are now in wide use on forest property and there can be little doubt that their use will continue. Marks on living trees should be placed in most cases on a peeled or blazed surface of the wood, though bark marks, much distorted it is true, have been known to remain legible for a very long time.

Corners in every case should be plainly inscribed so that any interested person may readily identify them. It is usual in woods practice for the surveyor who establishes a

corner to leave there his initials, or some mark peculiar to him which will identify it as his work, together with the year in which the survey was made. The same thing may be done by a succeeding surveyor.

Practice in all these matters, however, varies a good deal in different parts of the country. The methods prescribed for use in the United States land surveys will be found on later pages of this volume.

**Lines.** A property line in the forests of Germany is kept cleared out several yards wide and blocks of cut stone are deeply set along it near enough together so that one may be seen from another. In addition, the range of a transit line is inscribed upon them. This renders the property limit prominent and durable, and, further, defines it to within a quarter of an inch.

Such ideal marking is seldom to be looked for in this country, but the ends to be aimed at, which in the foregoing case were attained, should be in the mind of every man who has to do with forest boundaries. A property owner's interests are first, to have his bounds *prominent* so that he and other parties may know where they are and so that there will be no excuse for trespass; second, to have them *durably* marked for obvious reasons; and third, to have them so *closely defined* that all possible causes of dispute may be avoided.

Stone walls, ditches, and fences are the common bounds of property in settled and half-settled countries, and each of these methods of delimitation has its grade of efficiency, considered from the above points of view. In large forest areas blazed trees are the means almost universally employed for the purpose. That system has been reasonably satisfactory in the past. It would have been more so had care and system always been employed in the marking and more attention paid to renewal.

The directions for marking lines in timbered lands, as contained in the "Manual of Instructions for the Survey of the Public Lands of the United States," are as follows:

All lines on which are to be established the legal corner boundaries will be marked after this method, viz.: Those trees which may be intersected by the line will have two chops or notches cut

on the sides facing the line, without any other marks whatever. These are called sight trees or line trees. A sufficient number of other trees standing within 50 links of the line, on either side of it, will be blazed on two sides diagonally or quartering toward the line, in order to render the line conspicuous, and readily to be traced in either direction, the blazes to be opposite each other, coinciding in direction with the line, where the trees stand very near it, and to approach nearer each other toward the line, the farther the line passes from the blazed trees.

Due care will ever be taken to have the lines so well marked as to be readily followed, and to cut the blazes deep enough to leave recognizable scars as long as the trees stand. This can be attained only by blazing through the bark to the wood. Trees marked less thoroughly will not be considered sufficiently blazed. Where trees two inches or more in diameter occur along a line, the required blazes will not be omitted.

Lines are also to be marked by cutting away enough of the undergrowth of bushes or other vegetation to facilitate correct sighting of instruments.

These directions are ample, have been tested by use, and are practically the same as those issued for land survey work in the Dominion of Canada. Plainly, however, they are adapted to sparsely wooded land, for, in real timber growth, blazed trees two rods away from the line would be a source of confusion. In fact, the narrower a line is blazed, so long as it is clear and durable, the better. A good general rule to be applied in timber is to blaze those trees, and only those, which a man can reach with his axe when standing directly in the line.

A line in ordinary woods well blazed according to this method is prominent, and reasonably durable, while the quartering of the spots and special marking of the "line" trees render it reasonably well defined. If decent care is used in maintenance, and if when it has become dim or doubtful it is thoroughly and carefully renewed, there need be no great trouble or expense involved in that process, and no trespass or dispute meanwhile. Certain identification of the "line" trees of a previous authoritative survey is a great help in renewal. In the United States system that is secured by notching those trees; in the province of New Brunswick they are blazed and the blazes hacked three times upward. The same thing might be secured, and in addition the work of the individual surveyor identified,

by a personal mark, such as a stamp cut on the poll of the blazing axe.

#### 4. ORIGINAL SURVEYS AND RESURVEYS

The woods surveyor has two broad classes of work to do, — the running of new lines, outlining property for sale or administration, and the work of relocation. The first class of work constitutes an original survey, which the surveyor must carry out with due regard, on the one hand to accuracy, on the other to cost. His ordinary duty here consists of three parts: first, to duly outline and measure the tract in question; secondly, to mark the bounds of it in satisfactory fashion; third, to take notes of what he does for record and the benefit of those who come after.

**Resurveys.** When a boundary has once been surveyed, marked on the ground, and accepted, it becomes authoritative, and the usual duty of the man who comes after is simply to locate the work of the original surveyor. He uses the compass commonly as the best means of finding the old lines and corners. He may use the chain for the same purpose, or to satisfy himself about area. But his business, so far as the boundary itself is concerned, is to find and remark the old one, not set up a new one according to his notions of propriety. In relocating that boundary the marks of the earlier surveyor are a more reliable guide than his notes: they must, however, be clearly identified and not confused with those of irresponsible parties. On the other hand, where monuments cannot be found, reliable verbal testimony is admitted, while it has further to be recognized that property boundaries may become sanctioned by use or agreement, even though they are crooked and astray from their original location.<sup>1</sup>

#### 5. AGE OF SPOTS OR BLAZES

A subject of special interest to the forest surveyor is the determination of the age of spots on trees. This means

<sup>1</sup> For both legal and practical guidance in resurvey work, see "Restoration of Lost or Obliterated Corners," by the Land Office, and Hodgman's "Land Surveying."

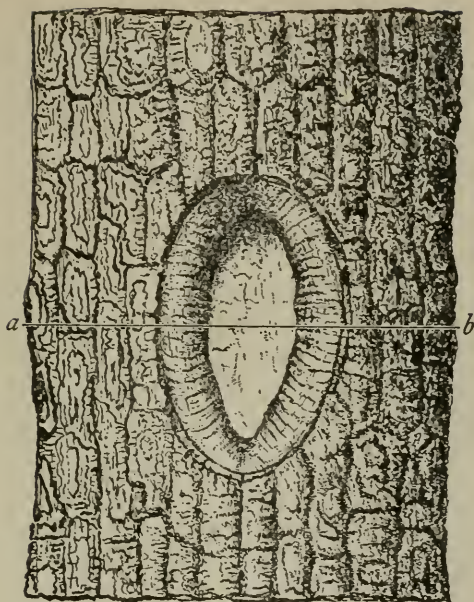

A

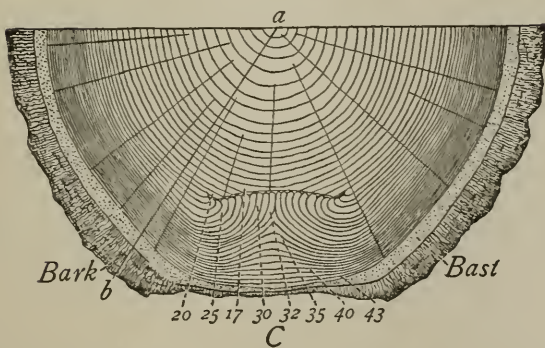
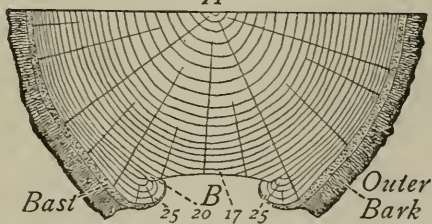

C

A. B. BLAZE FIVE YEARS AFTER CUT WAS MADE : A, FRONT VIEW SHOWING RIM OF CALLUS ; B, CROSS SECTION

C. BLAZE TWENTY-THREE YEARS AFTER CUT WAS MADE

of identifying a surveyor's work is recognized by all the courts. The handling of the problem in the field may be made clearer by the accompanying figures, reproduced from Circular No. 16, Division of Forestry, United States Department of Agriculture.

## 6. NOTES

Notes should be full and exact so as to furnish for the benefit of later comers a complete record of the work done. In the case of resurveys they should be particularly clear as to the old marks found, so that the evidence which governed in the resurvey may be a matter of record. This rule holds especially in regard to starting points and corners.

The date of a survey is an important thing to record clearly, along with the meridian which was used, whether magnetic, true, or one assumed for the occasion.

Notes should be so plainly and clearly written that any fairly intelligent man can understand them. They should be honest as well, not concealing actual errors. When the lines of a survey do not close in exactly, it may not be worth while to rerun them, but there ought at least to be no dodging of the facts. It is only an incompetent surveyor who will not acknowledge his errors. Errors are normal and to be expected. They grow out of imperfections in method that are imposed on the surveyor by limitations in the matter of expense. Errors are not to be confused with mistakes or blunders.

The notes of a timber land survey should also be full as regards topography. Such notes often give great assistance in the relocation of lines and corners. They are also of value to the owner and operator of such property.

## 7. PARTY AND COST

The great advantages of compass and chain surveying for woods work are that it is sufficiently accurate for most purposes, and that the cost involved is very moderate. Six

Renewal of south line of Twp., 5R.4, Oxford Co., Maine Sept. 25, 1905.  
Line originally run by E. Ballard in 1794, has been blazed over some since, but

never resurveyed. E.S. Dearborn, rear chain.

Have traced down and proved the east line of the township to a line of spots running west supposed to be its south line. Search along this shows within 20 rods a spruce and a birch with very old blazes which prove as near as the rings can be counted to be 111 years old. A blaze of like age is also found 3 rods to the eastward. No sign seen of the original corner, noted as being in a birch.

In range of the spots east and west and in the line coming south set a cedar post and stones. This is in flat spruce land and 9 rods from Island Pond to the eastward. Marked the post on N.W. T.5 R.4; on N.E. T.4 R.4, on S. T.5 R.3, also "J.J.B. 1905." The witness trees, also marked J.J.B. 1905, are a cedar standing N 10° E 10 links from the post, another S. 50° E 18 links, a spruce S. 30° W 20 links & a birch N. 45° W 12 links.

From the post ran a trial line N. 83° W. at right angles to the N & S line. After 85 rods found another original blaze 20 links to the left. Returned to post and ran N. 83° 30' W.

Rods

- 80 Marked a birch right of line  $\frac{1}{4}$  M  $\rightarrow$
- 120 Rising onto the height of a ridge which falls off precipitously 2 rods to the south. Original timber blown down and rotten here and some rods ahead. Found 3 of Ballard's spots close to the swamping and some spots by lumbermen often wide of the line. Blazed through straight.
- 160 Marked a spruce right of line.  $\frac{1}{2}$  M  $\rightarrow$  Slope S.W
- 210 Down a strong slope S.W. Old spots have been hauling to the right and now one on a birch with 111 rings over it is 30 links right. Offset to it, fill in the line back over the old spots, and continue on same bearing.
- 240 Set a cedar stake marked  $\frac{3}{4}$  M  $\rightarrow$
- 256 Water crosses to Southwest
- 275 Last 40 rods through swamp with mainly young growth and no spots to be seen. Old blaze probably Ballard's found now on a dead and down cedar.
- 295 Cross Canada hay road.
- 320 A spot of Ballard's age on a spruce just back 2 rods South are spots of much less age which come into the range a few rods further on. Blazed the line through straight Set a post for the corner of sections 35 & 36 marked on N.W. "S. N° 35." on N.E. "S. N° 36.", on S. "T.5 R.3" Marked it and the witness trees "J.J.B. 1905."

Woodstock, Mass., May 20, 1907 Survey made for Clark Lumber Co of their Parker Lot so called Decl. of needle as near as known 11°. W.S. Weston &  
R.W. Howard, Chain

Bearing	Dist.	
Begin at		Southwest corner of lot at junction of stone walls marking recognized boundaries of the lot. Thence —
N 10° E	847'	Along wall to its end
	1917'	through pine timber both sides with no sign of property
	(total)	line, to a rotten fence running easterly. The deeds calling for a line running "in a northerly direction," I blazed the line through on the range of the wall and set a post and stones at its north end.
		This is on ledgy ground with a drop off 10 feet west.
S 79° 35' E.	1054'	Along the old fence line Small brook runs N at 680 ft. to S E corner of the lot lying north, as indicated by range of old farm wall run in from the north to this point. Set a stone block on end and surrounded it with stones Set several heaps of stones along the line.
N 10° E	950'	On range of farm wall mentioned and roughly along the bound of the cutting, in swampy land after 200'. Set stakes along the line each 200' and at the end a post with heap of stones.
S 80° E	50'	At right angles to the range line to Cohasse brook. This distance is the one (3 rods) called for in the deed and is the only means of fixing the last named corner on the north and south line.
S 35° E	176'	
S 53° E	319'	Along Cohasse brook as per call of deed.
S 80° E	335'	Across brook, then on south border of field in possession of owners north, to west side of highway. This point is 716 ft southerly from the forks of the highway, the deed calling for "about 40 rods" Set post and stones.
S 26° W	168'	Down highway to bridge over Cohasse brook as called for in deed
S 20° 30' E	250'	
S 40° 30' E	133'	
S 26° W	712'	In the swamp close to foot of the ridge
S 12° W	285'	Offset frequently to get exact area of the "hard land" which was conveyed in the deed To stone wall, the recognized south bound of the lot
S 38° W	720'	
S 22° W	562'	
N 84° W	296'	Along wall, up a precipitous slope
N 78° 30' W	1086'	Along the wall to place of beginning
This survey follows the terms of the deeds as near as they can be interpreted John Armstrong, a resident of the locality 30 years and familiar with its land transfers and occupancy was present and says the location agrees as near as he knows with the understanding of the old parties and facts of possession. Location, therefore, good The posts set are marked on the side surveyed C. L. Co 1907" and also with my initials		

men form a usual party for line work in the northern woods, and from one to three miles a day can commonly be run with it, according to the ground and growth. The usual expense for such work ranges between \$6 and \$10 per mile. A reliable transit line, on the other hand, cannot be cleared out and run for twice those figures.

The work of the forest surveyor may be done for the following purposes, and the party required for each sort of work, outside of maintenance, is noted in connection.

1. New work, for the purpose of sale or administration. Party required: compassman, two chainmen, enough men, commonly three, ahead of the compass, with axes and a rod, to keep the rest of the party busy.

2. Resurvey, for the sake of reëstablishing lines and corners, also for getting area. Party: same as above; or it may be more economical in some circumstances not to employ chainmen, but for the surveyor himself, with one of his party, to go back and do the chaining.

3. Careful resurvey with the compass of old lines, no chainage required. Party to correspond.

4. Remarking lines where no great difficulty is expected, but where the lines need freshening. The man in charge and two axemen form an economical party. A small folding sight compass may be used as needed.

Balance in the party is one element largely influencing cost. The main thing is to have sufficient axemen to give the rest of the party enough to do. Subsistence is an important problem in some circumstances. A chainman can carry a pack on his work, and frequently chainmen are employed on long jobs in the backwoods to carry a portion of the supplies or outfit.

## SECTION V

### COMPUTATION AND OFFICE WORK

#### 1. TRAVERSE

To "traverse" a line or route is to survey it by any method that ascertains direction and distance. The cir-

cuit of a farm's boundaries by compass and chain is a traverse. So is the survey of a road by usual methods.

When a survey has been made in this fashion the notes are for some purposes best worked up after a method called "computing by traverse," the principles and applications of which are developed in the following paragraphs.

If a course is run out N 30° E 20 chains, a certain distance is made in a northerly direction, also a certain distance in a direction east. The distance made in the former direction is called **latitude**; in the latter, **departure**. In this case it is north latitude and easterly departure. These elements may be made evident on a plot by drawing a meridian and base line through the starting point and lines perpendicular to these from the point reached. These distances are also to be obtained from **traverse tables**.

The same is true of a course run in any direction and for any distance. Any course not run exactly east and west makes northing or southing. The former is reckoned as positive latitude, with the sign (+). The latter is negative or (-) latitude. Similarly, distance made in an easterly direction is (+) departure; that made towards the west (-) departure. If several courses are run in succession, the sum, algebraically reckoned, of their latitudes and their departures gives the position of the point finally attained.

This method of reckoning, using traverse tables for the purpose, has a wide use in connection with land surveying. The traverse table given on pages 214-219 furnishes the elements for 15' courses, those usually employed in compass work. The following is a simple problem illustrating their use.

In running a section line due north, the surveyor comes to a lake shore. Setting there a post, duly marked, he runs round the lake near the shore by the following courses:

N 50° E	12	chains.
N 9° 30' E	20	"
N 40° W	9	"
S 80° W	6.81	"

Reckoning up his courses by the traverse table, he finds

that his E and W departures balance, hence he should be in line. The difference between northing and southing gives him the distance. He may then set a second post, add the distance to his previous chainage, and proceed with his survey.

## COMPUTED TRAVERSE

Field Notes.		From Traverse Tables.			
Bearing.	Distance.	Latitude.		Departure.	
		N.	S.	E.	W.
N. 50° E.	12.0 chains	7.71	. .	9.19	...
N. 9° 30' E.	20.0 "	19.73	. .	3.30	...
N. 40° W.	9.0 "	6.89	. .	...	5.78
S. 80° W.	6.81 "	. . .	1.18	...	6.71
		34.33	1.18	12.49	12.49
		1.18			
Distance due north		33.15 chains		Balance	

When a closed survey is made, that is to say, when a surveyor starts and finishes at the same point, it is evident that its (+) and (-) departures should be equal, also its (+) and (-) latitudes. Owing to the errors unavoidable in survey work it is very seldom that they do so reckon up exactly. The amount by which the two ends fail to meet, whether plotted or reckoned, is the **error of closure**, and the **percentage of error** is the ratio of this distance to the total length of the survey. A certain percentage of this error, say 1 in 500 or 1 in 300, may be allowable in an ordinary woods survey. For plotting and for area, however, it may be desirable to distribute the error through the different courses, and this, when the traverse has been reckoned out, is readily done. The error in both latitude and departure is usually distributed to the different courses in proportion to the length of each, but if any course was more difficult of chainage than the others, it may be given extra weight in

the distribution. In any case the correction is applied so as to help close the survey and not the reverse. This process is called **Balancing a Survey**.

The field notes of a closed survey, the latitudes and departures as they reckon out, and the same balanced, are given herewith. The reckoning is also given, and all is in convenient arrangement. The latitudes and departures

## COMPUTING LATITUDES AND DEPARTURES

	Course. A — B	Course. B — C	Course. C — D	Course. D — E	Course. E — A
log sin =	9.9386	9.7604	9.5340	9.9555	9.5163
log dist. =	1.3010	1.1790	1.0910	1.2109	1.3444
log dep. =	1.2396	0.9394	0.6250	1.1664	0.8607
Departure =	17.36	8.70	4.22	14.67	7.26
log cos =	9.6957	9.9125	9.9730	9.6340	9.9752
log dist. =	1.3010	1.1790	1.0910	1.2109	1.3444
log lat. =	0.9967	1.0915	1.0640	0.8449	1.3196
Latitude =	9.92	12.35	11.59	7.00	20.87

in this case have been reckoned out not from the traverse table, but from the table of logarithmic sines and cosines. A little consideration shows that the latitude of a course is the cosine of its bearing multiplied by its distance, while the departure is the product of the sine multiplied by the distance. Now a table of sines and cosines gives values to single minutes instead of for 15' bearings. Logarithmic computation, too, shortens the process. This is, therefore, the more convenient way of reckoning for transit work, or for accurate compass surveying.

When all but the final course has been run, it is in some circumstances desirable to ascertain what course to set in order to hit the starting point. This, too, may readily be done by means of the figured latitudes and departures.

Thus, suppose that four courses of the above survey have

BALANCING A CLOSED SURVEY

Station.	Courses.		Latitude.		Departure.		Balanced.			
	Bearing.	Distance.	N.	S.	E.	W.	N.	S.	E.	W.
A	S. 60° 15' E	20.00 chains	...	9.92	17.36	...	...	9.95	17.38	...
B	N. 35° 10' E	15.10 "	12.35	...	8.70	...	12.32	...	8.72	...
C	N. 20° W	12.33 "	11.59	...	...	4.22	11.57	...	...	4.21
D	N. 64° 30' W	16.25 "	7.00	...	...	14.67	6.97	...	...	14.65
E	S. 19° 10' W	22.10 "	...	20.87	...	7.26	...	20.91	...	7.24
		85.78 "	30.94	30.79	26.06	26.15	30.86	30.86	26.10	26.10
			30.79			26.06				
			.15			.09				

Error in latitude .15 ch. = 1 link per each 5.7 ch. of perimeter, to be added to southings and subtracted from northings.  
 Error in departure .09 ch. = 1 link per each 9½ ch. of perimeter, to be added to eastings and subtracted from westings.  
 Error of closure =  $\sqrt{.15^2 + .09^2} = .175$  links.  $\frac{17.5}{8578} = 1$  in 490.

been run out and the latitude and departure computed, as given. The result shows that the point reached is north

FIGURED LATITUDES AND DEPARTURES

	Latitude.		Departure.	
	N.	S.	E.	W.
A — B	...	9.92	17.36	
B — C	12.35	...	8.70	
C — D	11.59	...	...	4.22
D — E	7.00	...	...	14.67
	30.94	9.92	26.06	18.89
	9.92		18.89	
	21.02		7.17	

and east of the starting point, much further north than east; hence a course somewhat west of south must be set to reach it. In the figure  $E X$  represents the latitude reached and  $A X$  the departure.

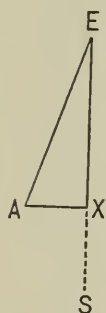

Now to find the bearing of  $E A$  we have

$$\tan. A E X = \frac{A X}{E X} = \frac{7.17}{21.02} = .3411.$$

$A E X$  from the table of tangents =  $18^{\circ} 50'$ .  
S  $18^{\circ} 50'$  W is therefore the bearing required.

The length of  $E A$  may also be found, since it is the hypotenuse of a right angled triangle whose base and altitude are the latitude and departure given.

$$\sqrt{21.02^2 + 7.17^2} = 22.21,$$

the distance required. That this value and that for the angle differ somewhat from the true ones is due to the errors of compass surveying.

In a similar way the course and distance of an inaccessible line may be computed or omissions supplied in notes.

That is a very undesirable thing to do, however, as it infringes on the tests which serve to verify the work.

## 2. AREA

**Rectangles.** The woodsman in his land work has most frequently to do with rectangular figures, and computation of area is simple. If the average of the chained east and west sides of a rectangular piece of land is 201 rods or 50.25 chains, and the north and south dimension 40 chains, the area equals  $50.25 \times 40 \div 10$  (the number of square chains in an acre), or 201 acres. So with a rectangular piece of any dimensions.

**Area by Triangles.** The area of a triangle of known base and altitude is half the product of these dimensions, and an irregular figure when plotted may be cut into triangles, the dimensions of each measured, and the areas computed. The same process in case of necessity may be performed on the ground.

When, as is frequently the case, it is easier to obtain the three sides of a triangle than the base and altitude, the area may be obtained from the formula

$$\text{Area} = \sqrt{s(s-a)(s-b)(s-c)},$$

where  $a$ ,  $b$ , and  $c$  are the three sides and  $s$  is half their sum.

Or, lastly, an irregular figure when plotted may be reduced graphically to the triangular form and the area obtained at one computation by either of the methods just given.

The relations between units of distance and of area are given on page 19.

**By Offsets.** In surveying around the borders of a body of water, and in some cases when the exact border of a property presents great difficulties, it is customary to run as near the border as is practicable and to take rectangular offsets to it at selected intervals along the line. These offsets should be measured to angles in the border, or placed near enough together so that the border between offsets may be considered a straight line. The area of the figure between each two offsets may then be computed by multiplying the distance along the base by half the sum of the two offsets.

Another way is to take the offsets at regular distances along the base, 10 rods apart for instance. In that case the rule for the area is:—Add together all the intermediate offsets and half the end offsets, and multiply the sum by the constant interval between them.

**By Cross Sectioning.** The method of ruling off an area on a map into squares of equal and known size is very convenient, especially for irregular areas like bodies of water. The whole squares can be counted up and the fractions of squares estimated. In such cases it may be best to do the ruling not on the map itself but on a detached piece of tracing cloth or of paper. If the map is opaque, the ruled tracing cloth may be laid over it and held firmly till the work is done. If it is transparent, the ruled sheet may be laid underneath.

**By Planimeter.** The area of any surface may be quickly and accurately ascertained by an instrument called the planimeter. That instrument is not, however, in the hands of most woodsmen.

**From Traverse.** The area enclosed by a balanced survey may be accurately computed from the latitude and departure of its courses. The general scheme will be grasped at once from the figure, in which  $A B C D E$  represents the survey whose notes are given on page 35,  $e b$  is a meridian through its most westerly point,  $b B$ ,  $c C$ ,  $d D$ , and  $e E$  are lines drawn vertical to it from the angles, and  $B m$ ,  $D n$ , and  $E o$  are parallel to it or vertical to  $c C$  and  $d D$ . In this figure it is evident in the first place that

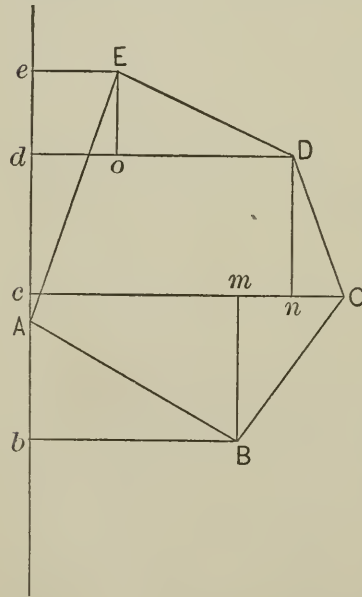

the area of the figure  $b B C D E e$  minus the area of the two triangles  $A E e$  and  $A B b$  equals the area of  $A B C D E$ , and secondly that the figure  $b B C D E e$  is made up of

the three trapezoids  $b B C c$ ,  $c C D d$ , and  $d D E e$ . The area of these trapezoids and triangles is easily computed from their dimensions. All that is necessary is to express those dimensions clearly in terms of latitude and departure.

One dimension of these figures, the altitude, is the latitude of the course in question. Thus for the triangle  $A B b$ , the altitude  $A b$  is the latitude of the course  $A B$ , and in the same way  $e A$ , the altitude of the triangle  $A E e$ , is the latitude of  $E A$ . These latitudes, it is to be noted, are negative and, to correspond, the areas of  $A B b$  and of  $E A e$  are to be deducted from  $b B C D E e$  to give the area of  $A B C D E$  which we are after.  $B m$ , the altitude of the trapezoid  $b B C c$ , is the latitude of the course  $B C$  and is positive.  $D n$  and  $E o$  have the same relation to the two succeeding courses.

The bases of these triangles and trapezoids are clearly related to departure.  $b B$  is the departure of the course  $A B$ , and  $A b \times b B =$  twice the area of  $A B b$ .  $b B + c C$ , the two bases of the trapezoid  $b B C c$ , = twice the departure of  $A B$  + the departure of  $B C$ .  $c C + d D =$  the same expression as the last + the departure of  $B C$  + the departure of  $C D$ , which last, however, being westerly, is reckoned negatively. Now a general expression for these values is **double meridian distance**, meridian distance being perpendicular distance from the meridian. The D. M. D. of a course is the sum of the meridian distances of its two ends. For a course starting on the meridian it equals the departure of the course. For any succeeding course it equals the D. M. D. of the preceding course plus the departure of that course plus the departure of the new course, easterly departures being reckoned as positive and westerly departures as negative.

A check on the reckoning of the D. M. D.'s is in the last one, which should be numerically equal to the departure of the last course.

These elements for convenient working out of the area surrounded by a closed survey are embodied in the following rule: — Twice the area of the figure enclosed by a survey is equal to the algebraic sum of the products of the

D. M. D.'s of the several courses multiplied by the corresponding latitudes, north latitudes being reckoned positively and south latitudes negatively. If the tract is kept on the right in the course of the survey, the result comes out with a minus sign.

An operation of this kind, starting with the balanced latitudes and departures, may be conveniently arranged as follows:

Course.	Lat.	Dep.	D. M. D.	+ Area.	- Area.
A — B	— 9.95	+ 17.38	17.38	....	172.93
B — C	+ 12.32	+ 8.72	43.48	535.67	...
C — D	+ 11.57	— 4.21	47.99	555.24	...
D — E	+ 6.97	— 14.65	29.13	203.04	...
E — A	— 20.91	— 7.24	7.24	....	151.39

1293.95	324.32
---------	--------

324.32
--------

2)969.63
----------

484.81
--------

sq. ch.

Area = 48.48 acres.

### 3. PLOTTING

The computation of traverse, if it aids in testing the accuracy of a survey, gives also data for plotting it with ease and accuracy. Taking the initial point of the survey as the starting point for a meridian and a base line vertical to it, the position of the second point of the survey may be fixed by measuring off its latitude on the vertical line, its departure on the horizontal, and from these points drawing lines parallel to the base and the meridian until they intersect. The latitude of the second course may then be added to that of the first and the two departures also added together, when the third point of the survey may be fixed in the same way as before, and so on until the survey is finished. The points thus fixed may then be joined by lines representing the courses. The position of the points in the above survey as taken from the balanced figures on

page 35 is given in the table, and below is a diagram showing the method of plotting.

Point.	N.	S.	E.	W.
A	. . .	. . .	. . .	
B	. . .	9.95	17.38	
C	2.37	. . .	26.10	
D	13.94	. . .	21.89	
E	20.91	. . .	7.24	

It is not, however, the most common practice to plot a survey after this fashion. The more usual way is to plot the angles and distances directly from the notes. To do this select a point on the paper for the initial point of the survey and draw a meridian through it in pencil. Then by means of a protractor mark the bearing of the first

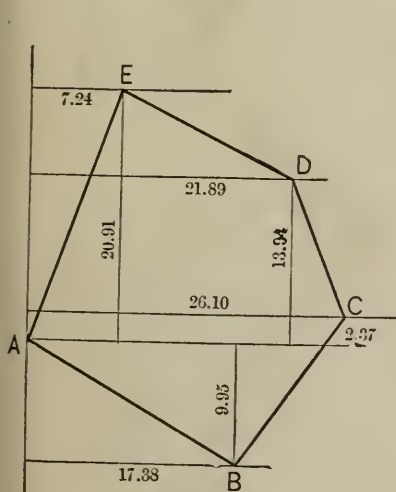

FIG. 1

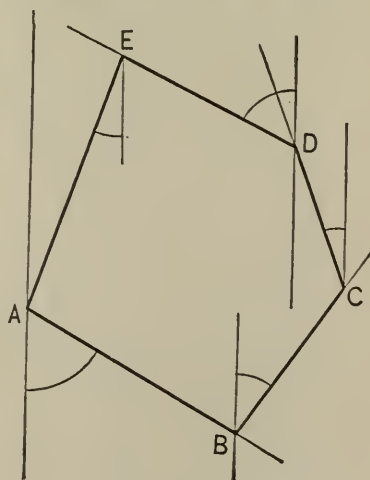

FIG. 2

METHODS OF PLOTTING A SURVEY.

FIG. 1 BY LATITUDES AND DEPARTURES. FIG. 2 BY COURSES AND DISTANCES.

course and draw a line of indefinite length through it. On this line lay off to scale the length of the course, thus

establishing the second corner. Through this draw another meridian in pencil and proceed as before. If the survey and the plotting are both perfect, the last course should hit the initial point. If it does not so hit, there is error in one or the other.

To plot one course from another by means of the figured angles between them is not good practice, because by that method errors accumulate.

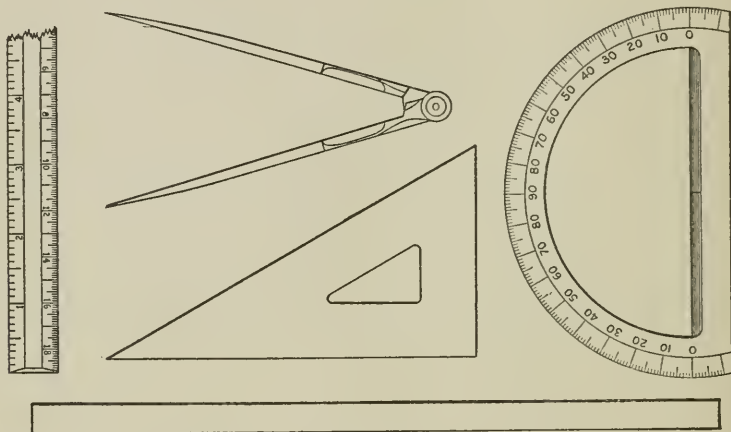

THE ESSENTIAL INSTRUMENTS FOR PLOTTING

A straight edge, a scale, a protractor, a pair of dividers, and a parallel ruler or a pair of triangles are the essentials for ordinary plotting.







The lettering on a woodsman's map ought to be plain. The size of the letters should be varied according to the importance of the object designated. It is a good rule to use erect letters in general, and slant capitals and italics in connection with water.

The usual practice is to represent waters and swamps with blue ink, contours with brown, and all other objects with black. Common brown and blue inks, however, do not blueprint well, so black is ordinarily used for tracings.

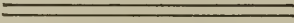
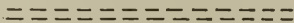
Various systems have been devised for representing the character and density of timber growth. A system of that kind, if one is required, is best devised for each forest region or property.

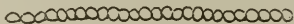
Maps may be rendered plainer by the judicious use of

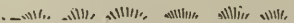
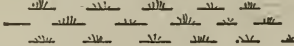
topographic symbols. A number that are in common use and generally agreed upon are given herewith.

Railroad . . . . .	
Highway . . . . .	
Wood Road . . . . .	
Trail . . . . .	
Stone Wall . . . . .	
Fence . . . . .	
Telephone Line . . . . .	
Field or Prairie . . . . .	
Open Swamp . . . . .	
Dam . . . . .	

TOPOGRAPHIC SYMBOLS

SECTION VI  
ON THE BEARING OF LINES

The surveying work of the woodsman of the present day is mostly of the nature of resurveys, or the subdivision of tracts whose boundary lines are on the ground. To ascertain correctly the present bearing of old lines is therefore a problem of great importance and one very frequently met with.

1. **Bearing Directly Observed.** The best and surest way to find that direction is the direct one of running a piece of the line. For example, suppose a section of land was run out in 1845 with lines stated to run north, east, south, and west by the true meridian. The surveyor coming on to retrace it in 1915 may pay no attention to the north star or reference meridians, but finding the southwest corner of the tract plain and running northerly find by trial

that N  $4^{\circ} 20'$  E runs through the old spots. He figures now that the courses he will have to run in order to reproduce the lines of the square are N  $4^{\circ} 20'$  E, S  $85^{\circ} 40'$  E, S  $4^{\circ} 20'$  W, and N  $85^{\circ} 40'$  W. He may run them so or turn the vernier of his compass  $4^{\circ} 20'$ , so as to read N, E, S, and W, like the compass of the original surveyor. In any case he will not be able to reproduce the old line all around exactly. Even if no errors are made in either survey the daily variation of the needle will be pretty sure to cause some divergence. In remarking the line he will follow as closely as possible the marks of the old surveyor.

**2. By Reference Meridian.** The change in bearing of old lines may often be ascertained by reading on a reference meridian. If the compass in use be so tested and if the compass which did the work to be reviewed was tested on the same marks at the time of the original survey, then the difference in the two bearings will hold closely for a considerable region around.

Example: On a county meridian in Pennsylvania in 1850 a surveyor's compass read N  $2^{\circ} 30'$  E and in the neighborhood a line was run bearing S  $55^{\circ}$  E. In 1905 another compass on the meridian reads N  $6^{\circ} 20'$  E, showing a change of  $3^{\circ} 50'$  in the time elapsed. Then S  $51^{\circ} 10'$  E ought to reproduce the line.

**3. By Tables.** The following tables, derived from publications of the United States Coast and Geodetic Survey, are very convenient for determining change in declination. They give for many localities well distributed throughout the United States declination at ten-year intervals as far back as it has been recorded. The change found to have taken place at a given locality between any two dates may then be applied through a considerable region around it. It should be understood, however, that this means of determination does not obviate the chances of error due to difference between instruments. It is well known that two compasses on the same line at the same time may not read exactly alike.

Example: A land line in the Adirondacks was run out in 1800 on the magnetic meridian. What course should be set in 1910 to reproduce it?

TABLE GIVING SECULAR CHANGE OF THE MAGNETIC DECLINATION IN THE UNITED STATES

(From U. S. Coast and Geodetic Survey Reports)

Year (Jan. 1)	Maine N <sup>th</sup> east	Maine S <sup>th</sup> west	New Hamp.	Ver- mont	Mass. East	Mass. West
	° /	° /	° /	° /	° /	° /
1750	12 05W	8 34W	8 02W	7 43W	7 46W	6 21W
1760	11 53	8 15	7 28	7 09	7 19	5 52
1770	11 53	8 10	7 03	6 44	7 00	5 31
1780	12 05	8 10	6 47	6 28	6 50	5 19
1790	12 26	8 15	6 42	6 23	6 50	5 17
1800	12 58	8 34	6 49	6 30	7 01	5 25
1810	13 38	9 02	7 06	6 47	7 20	5 54
1820	14 23	9 38	7 32	7 13	7 47	6 08
1830	15 12	10 18	8 11	7 48	8 22	6 41
1840	16 02	10 57	8 56	8 29	9 04	7 21
1850	16 58	11 38	9 46	9 13	9 48	8 05
1860	17 43	12 18	10 31	9 59	10 28	8 43
1870	18 13	12 48	11 08	10 39	11 01	9 17
1880	18 34	13 22	11 38	11 14	11 32	9 58
1890	18 44	13 51	12 03	11 39	12 02	10 25
1900	19 02	14 21	12 31	12 08	12 34	10 59
1910	19 45W	15 06W	13 16W	12 57W	13 21W	11 42W

Year (Jan. 1)	Rhode Island	Conn.	N. Y. East	N. Y. West	Penn. East	Penn. West
	° /	° /	° /	° /	° /	° /
1750	7 04W	5 47W	7 35W	4 40W	4 47W	
1760	6 37	5 18	6 53	3 57	4 01	
1770	6 18	4 57	6 17	3 18	3 19	
1780	6 08	4 45	5 50	2 46	2 44	1 16W
1790	6 08	4 43	5 34	2 24	2 21	0 52
1800	6 19	4 51	5 28	2 13	2 08	0 37
1810	6 38	5 08	5 34	2 13	2 09	0 31
1820	7 05	5 34	5 50	2 24	2 22	0 37
1830	7 40	6 07	6 17	2 46	2 47	0 52
1840	8 22	6 47	6 53	3 18	3 21	1 16
1850	9 06	7 31	7 39	3 57	4 04	1 48
1860	9 46	8 09	8 25	4 46	4 46	2 26
1870	10 19	8 43	9 04	5 23	5 32	3 06
1880	10 50	9 24	9 51	6 16	6 16	3 50
1890	11 20	9 51	10 14	6 57	6 50	4 28
1900	11 52	10 25	10 48	7 37	7 25	5 07
1910	12 40W	11 11W	11 31W	8 12W	8 07W	5 45W

TABLE GIVING SECULAR CHANGE OF THE MAGNETIC DECLINATION IN THE UNITED STATES

(From U. S. Coast and Geodetic Survey Reports)

Year (Jan. 1)	New Jersey	Ohio	Indiana	Illinois	Iowa	Mich. North
	° /	° /	° /	° /	° /	° /
1750	4 43W					
1760	4 04					
1770	3 31					
1780	3 06					
1790	2 50					
1800	2 45	3 13E	4 44E	5 54E		
1810	2 50	3 22	4 59	6 18		
1820	3 06	3 22	5 04	6 33	10 09E	6 42E
1830	3 31	3 13	4 59	6 37	10 24	6 42
1840	4 04	2 53	4 44	6 33	10 30	6 28
1850	4 43	2 24	4 21	6 18	10 24	6 02
1860	5 22	1 50	3 50	5 54	10 09	5 25
1870	6 01	1 14	3 13	5 26	9 44	4 38
1880	6 41	0 37E	2 35	4 44	9 06	3 47
1890	7 14	0 02W	1 57	4 05	8 21	2 58
1900	7 49	0 42	1 24	3 36	7 52	2 20
1910	8 33W	1 10W	1 08E	3 25E	7 57E	2 05E

Year (Jan. 1)	Michigan South	Wisconsin	Minnesota North	Minnesota South
	° /	° /	° /	° /
1750				
1760				
1770				
1780				
1790				
1800				
1810				
1820	4 10E	8 34 E	10 27E	11 20E
1830	4 04	8 40	10 44	11 36
1840	3 46	8 34	10 50	11 42
1850	3 20	8 16	10 44	11 36
1860	2 46	7 49	10 27	11 20
1870	2 04	7 14	9 59	10 54
1880	1 17	6 25	9 17	10 22
1890	0 32E	5 35	8 33	9 32
1900	0 02W	5 01	7 58	8 57
1910	0 27W	4 51E	8 03E	9 00E

TABLE GIVING SECULAR CHANGE OF THE MAGNETIC DECLINATION IN THE UNITED STATES

(From U. S. Coast and Geodetic Survey Reports)

Year (Jan. 1)	Washington D. C.	Maryland (Baltimore)	Virginia East (Richmond)	Virginia West (Lynchburg)	West Virginia (Charleston)	North Caro- lina East (Newbern)	North Caro- lina West (Salisbury)
1750	1 41W	3 05W	1 13W			0 18W	1 31E
1760	1 02	2 26	0 37	0 08E		0 18E	2 08
1770	0 28	1 52	0 05W	0 42		0 50	2 42
1780	0 01W	1 23	0 20E	1 11		1 17	3 12
1790	0 19E	1 05	0 38	1 33	2 00E	1 35	3 34
1800	0 28	0 56	0 47	1 46	2 15	1 44	3 48
1810	0 28	0 56	0 47	1 51	2 20	1 44	3 52
1820	0 19E	1 05	0 38	1 46	2 15	1 35	3 48
1830	0 01W	1 25	0 20E	1 33	2 00	1 16	3 33
1840	0 28	1 52	0 05W	1 11	1 37	0 50	3 10
1850	1 02	2 26	0 36	0 45	1 05	0 17E	2 40
1860	1 41	3 05	1 12	0 10E	0 30E	0 19W	2 06
1870	2 21	3 45	1 51	0 29W	0 12W	0 58	1 29
1880	3 00	4 24	2 29	1 09	0 51	1 35	0 51
1890	3 36	5 00	3 06	1 46	1 28	2 14	0 13E
1900	4 11	5 35	3 40	2 22	2 06	2 51	0 23W
1910	4 51W	6 15W	4 13W	2 53W	2 39W	3 25W	0 47W

Year (Jan. 1)	South Carolina (Columbia)	Georgia (Macon)	Florida East (Jack- sonville)	Florida West (Pensacola)	Florida South (Tampa)	Alabama (Montgom- ery)	Mississippi (Jackson)
1750	2 04E	3 16E	2 27E	5 00E	5 00E	2 52E	
1760	2 41	3 53	3 04	5 37	5 30	3 28	
1770	3 15	4 29	3 40	6 13	5 55	4 03	
1780	3 44	5 01	4 12	6 44	6 15	4 34	
1790	4 06	5 26	4 37	7 11	6 26	5 02	
1800	4 19	5 44	4 55	7 32	6 30	5 24	7 54E
1810	4 24	5 53	5 04	7 45	6 26	5 39	8 13
1820	4 19	5 53	5 04	7 50	6 15	5 47	8 24
1830	4 06	5 44	4 55	7 45	5 55	5 46	8 28
1840	3 44	5 26	4 37	7 31	5 30	5 38	8 24
1850	3 15	5 01	4 12	7 12	5 00	5 22	8 13
1860	2 41	4 29	3 40	6 45	4 28	5 00	7 57
1870	2 03	3 53	3 04	6 13	3 53	4 32	7 31
1880	1 25	3 14	2 25	5 34	3 16	3 54	6 55
1890	0 47	2 39	1 50	4 57	2 48	3 15	6 21
1900	0 11E	2 08	1 19	4 29	2 19	2 49	5 58
1910	0 12W	1 52E	1 05E	4 22E	2 06E	2 45E	6 08E

## TABLE GIVING SECULAR CHANGE OF THE MAGNETIC DECLINATION IN THE UNITED STATES

(From U. S. Coast and Geodetic Survey Reports)

Year (Jan. 1)	Tennessee East (Chattanooga)	Tennessee West (Huntingdon)	Kentucky East (Lexington)	Kentucky West (Princeton)	Louisiana (Alexandria)	Texas East (Houston)	Texas Mid- dle (San Antonio)
1750	° ' "	° ' "	° ' "	° ' "	° ' "	° ' "	° ' "
1760							
1770							
1780							
1790							
1800	5 07E		4 22E	6 32E	8 04E		
1810	5 16		4 31	6 50	8 25		
1820	5 16	7 24E	4 31	6 59	8 41	8 55E	
1830	5 07	7 24	4 22	6 59	8 49	9 10	9 37E
1840	4 49	7 16	4 04	6 50	8 48	9 19	9 48
1850	4 24	6 59	3 39	6 32	8 40	9 19	9 53
1860	3 52	6 35	3 07	6 07	8 24	9 12	9 48
1870	3 16	6 05	2 31	5 37	8 02	8 56	9 37
1880	2 36	5 29	1 53	4 57	7 26	8 29	9 19
1890	2 01	4 53	1 15	4 20	6 53	7 56	8 52
1900	1 30	4 24	0 41	3 51	6 33	7 44	8 43
1910	1 12E	4 18E	0 19E	3 36E	6 50E	8 05E	9 09E

Year (Jan. 1)	Texas West (Pecos)	Arkansas (Little Rock)	Oklahoma (Okmulgee)	Missouri (Sedalia)	Kansas East (Emporia)	Kansas West (Ness City)	Nebraska East (Hastings)
1750	° ' "	° ' "	° ' "	° ' "	° ' "	° ' "	° ' "
1760							
1770							
1780							
1790							
1800		8 13E					
1810		8 36					
1820		8 51		10 03E			11 39E
1830	10 46E	9 00		10 13			11 57
1840	11 00	8 59		10 13			12 07
1850	11 08	8 51	10 15E	10 04	11 34E	12 24E	12 07
1860	11 07	8 34	10 06	9 46	11 28	12 23	11 59
1870	11 00	8 14	9 51	9 24	11 12	12 12	11 41
1880	10 48	7 38	9 33	8 44	10 45	11 54	11 10
1890	10 24	7 01	9 07	8 02	10 07	11 21	10 31
1900	10 18	6 38	8 42	7 38	9 50	11 08	10 14
1910	10 50E	6 49E	8 55E	7 46E	10 08E	11 27E	10 28E

## TABLE GIVING SECULAR CHANGE OF THE MAGNETIC DECLINATION IN THE UNITED STATES

(From U. S. Coast and Geodetic Survey Reports)

Year (Jan. 1)	Nebraska West (Alliance)	South Dakota East (Huron)	South Dakota West (Rapid City)	North Dakota East (Jamestown)	North Dakota West (Dickinson)	Montana East (Forsyth)	Montana West (Helena)
1750	°	°	°	°	°	°	°
1760	'	'	'	'	'	'	'
1770							
1780							
1790							
1800							
1810							
1820							
1830							
1840		13 06E				18 09E	18 53E
1850	15 27E	13 06	16 26E	14 31E	17 37E	18 27	19 18
1860	15 27	12 57	16 26	14 21	17 37	18 36	19 36
1870	15 18	12 39	16 16	14 02	17 27	18 36	19 45
1880	14 50	12 07	15 50	13 31	17 00	18 21	19 34
1890	14 20	11 25	15 17	12 43	16 21	17 53	19 23
1900	14 10	11 07	15 07	12 24	16 10	17 50	19 31
1910	14 31E	11 28E	15 27E	12 44E	16 36E	18 17E	20 02E

Year (Jan. 1)	Wyoming East (Douglas)	Wyoming West (Green River)	Idaho (Boise)	Washington East (Wilson Creek)	Washington West (Seattle)	Oregon East (Sumpter)	Oregon West (Detroit)
1750	°	°	°	°	°	°	°
1760	'	'	'	'	'	'	'
1770							
1780							
1790					17 19E		
1800					17 52		
1810					18 27		16 05E
1820					19 04		16 43
1830					19 41		17 22
1840					20 16		18 01
1850	15 51E	16 45E	18 00E	21 16E	20 49		18 38
1860	15 59	16 58	18 30	21 37	21 19	19 15E	19 12
1870	15 59	17 02	18 45	21 52	21 45	19 40	19 41
1880	15 47	16 54	18 45	21 56	22 06	19 58	20 06
1890	15 24	16 36	18 39	22 06	22 19	20 09	20 24
1900	15 19	16 37	18 51	22 22	22 38	20 11	20 32
1910	15 43E	17 08E	19 31E	23 00E	22 58	20 26	20 50
					23 40E	21 07E	21 33E

## TABLE GIVING SECULAR CHANGE OF THE MAGNETIC DECLINATION IN THE UNITED STATES

(From U. S. Coast and Geodetic Survey Reports)

Year (Jan. 1)	California South (Los Angeles)	California Middle (San Jose)	California North (Redding)	Nevada East (Elko)	Nevada West (Haw- thorne)	Utah (Salt Lake)
1750	° /	° /	° /	° /	° /	° /
1760						
1770						
1780	10 24E	13 37E	14 07E			
1790	10 58	14 03	14 35			
1800	11 32	14 32	15 04			
1810	12 07	15 01	15 34			
1820	12 39	15 30	16 04			
1830	13 09	15 57	16 33			
1840	13 36	16 22	17 01			
1850	13 57	16 45	17 26	17 20E	16 16E	16 25E
1860	14 13	17 05	17 47	17 36	16 37	16 36
1870	14 24	17 20	18 06	17 41	16 52	16 40
1880	14 33	17 28	18 15	17 44	17 00	16 30
1890	14 36	17 32	18 20	17 38	17 02	16 20
1900	14 52	17 51	18 39	17 49	17 17	16 28
1910	15 35E	18 32E	19 22E	18 27E	17 58E	17 03E

Year (Jan. 1)	Colorado East (Pueblo)	Colorado West (Glen- wood Springs)	New Mexico East (Santa Rosa)	New Mexico West (Laguna)	Arizona East (Holbrook)	Arizona West (Prescott)
1750	° /	° /	° /	° /	° /	° /
1760						
1770						
1780						
1790						
1800						
1810						
1820						
1830						
1840						
1850	13 47E	16 07E	12 43E	13 26E	13 33E	13 19E
1860	13 50	16 15	12 47	13 33	13 44	13 33
1870	13 46	16 16	12 43	13 34	13 47	13 40
1880	13 31	16 04	12 29	13 22	13 40	13 36
1890	13 00	15 40	12 03	13 02	13 25	13 32
1900	12 53	15 39	11 59	13 02	13 29	13 44
1910	13 19E	16 10E	12 29E	13 36E	14 05E	14 25E

From the table for change of declination, and for the locality eastern New York, the values  $5^{\circ} 28'$  and  $11^{\circ} 31'$  are obtained, showing that the needle in the 110 years swung  $6^{\circ} 03'$  to the westward. The desired bearing therefore should prove to be N  $6^{\circ}$  E nearly.

## SECTION VII

### ON OBTAINING THE MERIDIAN

When for any reason it is necessary to determine a true meridian, that is best obtained from the north star. This star, easily identified by the range of the "pointers," is not exactly at the pole of the heavens, but in 1908 was  $1^{\circ} 11' 4''$  from it. This angle is called the "polar distance" of the star. It is decreasing at the rate of about one third of a minute yearly.

The north star, like other stars, is thus circling around the pole once in about 24 hours. When directly over or under the pole it is said to be in **culmination**, upper or lower as the case may be. The star is then in the meridian, and bringing it down with plumb line or transit gives the meridian directly.

When the north star is farthest from the meridian it is said to be in **elongation**, east when the star is east of the meridian, west when on the opposite side. A plane through the observer, the zenith, and the north star when at elongation, prolonged downward to the horizon, makes an angle with the meridian which is called the **azimuth** of the star at that time. This angle may be obtained for any time and position from tables, and setting off the angle, the true meridian is found. Upon this meridian the needle can be read or marks can be left for reference at any future time.

The operation of bringing down the star may be performed either with the plumb line or, more accurately and conveniently, with a well-adjusted transit. When the transit is used it is necessary to illuminate the cross wires. This may often be done by holding a lantern or candle in front of the transit tube and a little to one side, when the field should appear light with the cross hairs show-

ing as dark lines. If light enough is not so obtained, a tin reflector may be made of the design shown, or a piece of tracing cloth or greased paper with a hole cut in it may be bound bell-shape over the front of the instrument with a string or rubber band.

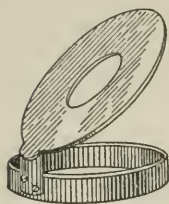

REFLECTOR

Directions for obtaining the true meridian which involve an accurate knowledge of time are not adapted to the use of the woodsman. The following directions do not impose that very difficult requirement.

(From United States "Manual of Instructions for Survey of the Public Lands.")

#### TO OBTAIN A MERIDIAN AT CULMINATION OF POLARIS

A very close approximation to a meridian may be had by remembering that Polaris very nearly reaches the meridian when it is in the same vertical plane with the star Delta ( $\delta$ ) in the constellation Cassiopeia. The vertical wire of the transit should be fixed upon Polaris, and occasionally brought down to the star Delta, to observe its approach to the same vertical line. When both stars are seen upon the wire, Polaris is very near the meridian. A small interval of time (as 6 min. in 1908) will then be allowed to pass, while Delta moves rapidly east and Polaris slightly east to the actual meridian. At that moment the cross wire should be placed upon Polaris, and the meridian firmly marked by stakes and tack-heads.

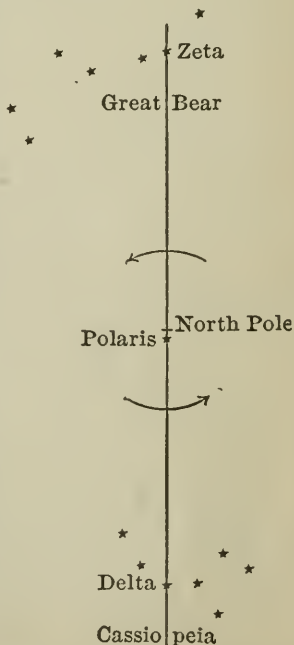

This method is practicable only when the star Delta is below the pole during the night; when it passes the meridian above the pole, it is too near the zenith to be of service, in which case the star Zeta ( $\zeta$ ), the last star but one in the tail of the Great Bear, may be used instead.

Delta ( $\delta$ ) Cassiopeiae is on the meridian below Polaris and the pole, at midnight about April 10, and is, therefore, the proper star to use at that date and for some two or three months before and after.

Six months later the star Zeta ( $\zeta$ ), in the tail of the Great Bear, will supply its place, and will be used in precisely the same manner.

The diagram, drawn to scale, exhibits the principal stars of the constellations Cassiopeia and Great Bear, with Delta ( $\delta$ ) Cassiopeia, Zeta ( $\zeta$ ) Ursæ Majoris (also called Mizar), and Polaris on the meridian, represented by the straight line; Polaris being at lower culmination.

In the above process, the interval of waiting time may be found for the proper year from the following data:

* For Zeta Urs. Maj.	{ 1910 . . . . 6.5 min.	{ annual
	{ 1920 . . . . 10.6 "	{ increase
	{ 1930 . . . . 14.7 "	{ .41 min.
For Delta Cass.	{ 1910 . . . . 7.1 min.	{ annual
	{ 1920 . . . . 11.0 "	{ increase
	{ 1930 . . . . 14.9 "	{ .39 min.

\* Data furnished by Prof. Robt. W. Willson.

Instead of the transit the plumb line may be used for this observation in much the manner described later on.

At certain times of year it is inconvenient to observe Polaris at culmination, and for other reasons as well it is more usual to observe the star at elongation. The Land Office instructions follow, and the table for azimuths of the star and for time of elongation which are required.

#### TO ESTABLISH A MERIDIAN AT ELONGATION BY TELESCOPIC INSTRUMENT

Set a stone, or drive a wooden peg, firmly in the ground, and upon the top thereof make a small, distinct mark.

About thirty minutes before the time of the eastern or western elongation of Polaris, obtained from the table, set up the transit firmly, with its vertical axis exactly over the mark, and carefully level the instrument.

Illuminate the cross wires by the light from a suitable lantern, the rays being directed into the object end of the telescope by an assistant; while great care will be taken, by perfect leveling, to insure that the line of collimation describe a truly vertical plane.

Place the vertical wire upon the star, which, if it has not reached its elongation, will move to the right for eastern, or to the left for western elongation.

While the star moves toward its point of elongation, by means of the tangent screw of the vernier plate it will be repeatedly covered by the vertical wire, until a point is reached where it will appear to remain on the wire for some time, then leave it in a direction contrary to its former motion; thus indicating the time of elongation.

Then while the star appears to thread the vertical wire, depress

the telescope to a horizontal position; five chains north of the place of observation set a stone or drive a firm peg, upon which by a strongly illuminated pencil or other slender object, exactly coincident with the vertical wire, mark a point and drive a tack in the line of sight thus determined; then, to eliminate possible errors of collimation or imperfect verticality of the motion of the telescope, quickly revolve the vernier plate  $180^\circ$ , direct the glass at Polaris and repeat the observation; if it gives a different result find and mark the middle point between the two results. This middle point, with the point marked by the plumb bob of the transit, will define the trace of the vertical plane through Polaris at its eastern or western elongation, as the case may be.

By daylight lay off to the east or west, as the case may require, the proper azimuth taken from the following table (page 56); the instrument will then define the meridian. The needle may be read then, giving the magnetic declination, east or west as the case may be. Or the line may be permanently marked for reference at another time or with another instrument.

#### TO DETERMINE A MERIDIAN WITHOUT A TELESCOPE

Attach a plumb line to a support situated as far above the ground as practicable, such as the limb of a tree, a piece of board nailed or otherwise fastened to a telegraph pole, a house, barn, or other building, affording a clear view north and south.

The plumb bob may consist of some weighty material, such as a brick, a piece of iron or stone, weighing four to five pounds, which will hold the plumb line vertical, fully as well as one of finished metal.

Strongly illuminate the plumb line just below its support by a lamp or candle, care being taken to obscure the source of light from the view of the observer by a screen.

For a peep sight, cut a slot about one-sixteenth of an inch wide in a thin piece of board, or nail two strips of tin, with straight edges, to a square block of wood, so arranged that they will stand vertical when the block is placed flat on its base upon a smooth horizontal rest, which will be placed at a convenient height south of the plumb line and firmly secured in an east and west direction, in such a position that, when viewed through the peep sight, Polaris will appear about a foot below the support of the plumb line.

The position may be practically determined by trial the night preceding that set for the observation.

About thirty minutes before the time of elongation, as obtained from the table, bring the peep sight into the same line of sight with the plumb line and Polaris.

To reach elongation, the star will move off the plumb line to the east for eastern elongation, or to the west for western elongation; therefore by moving the peep sight in the proper direction, east or west, as the case may be, keep the star on the plumb line until it appears to remain stationary, thus indicating that it has reached its point of elongation.

The peep sight will now be secured in place by a clamp or weight with its exact position marked on the rest, and all further operations will be deferred until the next morning.

By daylight, place a slender rod at a distance of two or three hundred feet from the peep sight, and exactly in range with it and the plumb line; carefully measure this distance.

Take from the table on page 56 the azimuth of Polaris corresponding to the latitude of the station and year of observation; find the natural tangent of said azimuth and multiply it by the distance from the peep sight to the rod; the product will express the distance to be laid off from the rod exactly at right angles to the direction already determined (to the west for eastern elongation or to the east for western elongation), to a point, which with the peep sight, will define the direction of the meridian with sufficient accuracy for the needs of local surveyors.

Example: Sept. 10, 1915, in latitude  $45^{\circ}$  N, longitude  $71^{\circ}$  W, it is desired to obtain the declination of the needle.

From the table giving times of elongation it is found that Polaris is at eastern elongation on Sept. 1st at 53.2 minutes past 8 P. M.

Correction A is not required in this case.

Correction B, for the 9 days elapsed since Sept. 1st, is 35.3 min., to be subtracted.

Correction C, for  $71^{\circ}$  longitude, is 16 min., to be subtracted.

Correction D, for  $45^{\circ}$  latitude, is 0.85 min., to be added.

Correction E is 0.2 min., to be added.

8 hrs. 53.2 min. — 35.3 min. — 16 min. + .85 min. + .2 min.  
= 8 hrs. 3 min., time of elongation by the watch.

The star having been observed at the time indicated and brought down to the horizon, its azimuth is ascertained from the table of azimuths. For 1915 and latitude  $45^{\circ}$ , this value is  $1^{\circ} 37.4'$  and there is no appreciable correction for apparent place. The meridian then is that much to the west of the line determined. In this case, with the instrument on the azimuth line the needle was allowed to settle and a reading of N  $17^{\circ} 50'$  E obtained.  $17^{\circ} 50' - 1^{\circ} 37.4' = 16^{\circ} 12.6'$ .  $16^{\circ} 12.6'$  is therefore the magnetic declination for the place and time, or  $16^{\circ} 15'$  as near as a needle can be read.

In practice corrections D and E may usually be neglected. Using the table for time of elongation with corrections A, B, and C applied to it, the surveyor will ascertain when to be on hand for the observation. Then, watching the star, when satisfied by its motion that it has reached elongation he will bring his instrument down without regard to time. In fact, Polaris traverses less than  $4'$  of azimuth in the hour before and the hour after elongation.

## AZIMUTH OF POLARIS WHEN AT ELONGATION FOR ANY YEAR BETWEEN 1909 AND 1920

(From United States Coast and Geodetic Survey)

Latitude	1917		1918		1919		1920		1921		1922		1923		1924		1925		1926		1927		1928	
	o	'	o	'	o	'	o	'	o	'	o	'	o	'	o	'	o	'	o	'	o	'	o	'
25°	1	15.3	1	15.0	1	14.7	1	14.3	1	14.0	1	13.6	1	13.3	1	13.0	1	12.6	1	12.3	1	11.9	1	11.6
26°		16.0		15.6		15.3		14.9		14.7		14.2		13.9		13.6		13.2		12.9		12.5		12.2
27°		16.6		16.3		15.9		15.6		15.2		14.9		14.6		14.2		13.9		13.5		13.2		12.8
28°		17.3		17.0		16.6		16.3		15.9		15.6		15.2		14.9		14.6		14.2		13.8		13.5
29°		18.1		17.7		17.4		17.0		16.6		16.3		16.0		15.6		15.2		14.9		14.6		14.2
30°		18.8		18.5		18.1		17.8		17.4		17.0		16.7		16.4		16.0		15.6		15.3		14.9
31°		19.7		19.3		18.9		18.6		18.2		17.9		17.5		17.2		16.8		16.4		16.1		15.7
32°		20.5		20.1		19.8		19.4		19.1		18.7		18.3		18.0		17.6		17.2		16.9		16.5
33°		21.4		21.0		20.7		20.3		19.9		19.6		19.2		18.8		18.5		18.1		17.8		17.4
34°		22.4		22.0		21.6		21.2		20.9		20.5		20.1		19.8		19.4		19.0		18.6		18.3
35°		23.3		23.0		22.6		22.2		21.8		21.5		21.1		20.7		20.4		20.0		19.6		19.2
36°		24.4		24.0		23.6		23.3		22.9		22.5		22.1		21.7		21.4		21.0		20.6		20.2
37°		25.5		25.1		24.7		24.3		24.0		23.6		23.2		22.8		22.4		22.0		21.6		21.3
38°		26.6		26.2		25.9		25.5		25.1		24.7		24.3		23.9		23.5		23.2		22.8		22.4
39°		27.8		27.5		27.1		26.7		26.3		25.8		25.5		25.1		24.7		24.3		23.9		23.5
40°		29.1		28.7		28.3		27.9		27.5		27.1		26.7		26.3		25.9		25.5		25.1		24.7
41°		30.4		30.0		29.6		29.1		28.8		28.4		28.0		27.6		27.2		26.8		26.4		26.0
42°		31.9		31.5		31.0		30.6		30.2		29.8		29.4		29.0		28.6		28.2		27.8		27.3
43°		33.4		32.9		32.5		32.1		31.8		31.2		30.8		30.4		30.0		29.6		29.1		28.7
44°		34.9		34.5		34.1		33.6		33.2		32.8		32.4		31.9		31.5		31.1		30.6		30.2
45°		36.6		36.1		35.7		35.3		34.8		34.4		34.0		33.5		33.1		32.6		32.2		31.8
46°		38.3		37.8		37.4		37.0		36.5		36.1		35.6		35.2		34.8		34.3		33.9		33.4
47°		40.1		39.7		39.2		38.8		38.3		37.9		37.4		37.0		36.5		36.1		35.6		35.2
48°		42.0		41.6		41.1		40.7		40.2		39.8		39.3		38.8		38.4		37.9		37.4		37.0
49°		44.1		43.6		43.1		42.7		42.2		41.7		41.3		40.8		40.3		39.9		39.4		38.9
50°		46.2		45.7		45.3		44.8		44.3		43.8		43.4		42.9		42.4		41.9		41.4		41.0

The table on the preceding page was computed with mean declination of Polaris for each year. A more accurate result will be had by applying to the tabular values the following correction, which depends on the difference of the mean and the apparent place of the star. The deduced azimuth will in general be correct within 0.3'.

For Middle of	Correction	For Middle of	Correction
	,		,
January	—0.5	July	+0.2
February	—0.4	August	+0.1
March	—0.3	September	—0.1
April	—0.0	October	—0.4
May	+0.1	November	—0.6
June	+0.2	December	—0.8

LOCAL CIVIL (NOT STANDARD) TIME OF THE ELONGATIONS OF POLARIS IN THE YEAR 1915. (COMPUTED FOR LATITUDE 40° NORTH AND LONGITUDE 90° OR 6<sup>h</sup> WEST OF GREENWICH)

(From United States Coast and Geodetic Survey)

Date	Eastern Elongation		Western Elongation	
	h.	m.	h.	m.
1915				
January 1	0	51.7 P. M.	0	46.0 P. M.
January 15	11	56.4 A. M.	11	46.8 P. M.
February 1	10	49.2 A. M.	10	39.7 P. M.
February 15	9	54.0 A. M.	9	44.4 P. M.
March 1	8	58.7 A. M.	8	49.2 P. M.
March 15	8	3.5 A. M.	7	54.0 P. M.
April 1	6	56.6 A. M.	6	47.1 P. M.
April 15	6	1.6 A. M.	5	52.0 P. M.
May 1	4	58.7 A. M.	4	49.2 P. M.
May 15	4	3.8 A. M.	3	54.2 P. M.
June 1	2	57.2 A. M.	2	47.6 P. M.
June 15	2	2.4 A. M.	1	52.8 P. M.
July 1	0	59.8 A. M.	0	50.2 P. M.
July 15	0	5.0 A. M.	11	55.4 A. M.
August 1	10	54.5 P. M.	10	48.8 A. M.
August 15	9	59.8 P. M.	9	54.1 A. M.
September 1	8	53.2 P. M.	8	47.5 A. M.
September 15	7	58.3 P. M.	7	52.6 A. M.
October 1	6	55.5 P. M.	6	49.8 A. M.
October 15	6	00.6 P. M.	5	54.9 A. M.
November 1	4	53.7 P. M.	4	48.0 A. M.
November 15	3	58.6 P. M.	3	52.9 A. M.
December 1	2	55.6 P. M.	2	49.9 A. M.
December 15	2	00.4 P. M.	1	54.7 A. M.

A. To refer the above tabular quantities to years subsequent to 1915:

For year	1917	subtract	0.7	minute	
	1918	add	0.9	minute	
	1919	add	2.5	minutes	
	1920	{ add	4.0	minutes	up to March 1
		{ add	0.1	minute	on and after March 1
	1921	add	1.6	minutes	
	1922	add	3.1	minutes	
	1923	add	4.5	minutes	
	1924	{ add	5.9	minutes	up to March 1
		{ add	2.0	minutes	on and after March 1
	1925	add	3.3	minutes	
	1926	add	4.6	minutes	
	1927	add	5.9	minutes	
	1928	{ add	7.2	minutes	up to March 1
		{ add	3.3	minutes	on and after March 1

B. To refer to any calendar day other than the first and fifteenth of each month, subtract the quantities below from the tabular quantity for the preceding date.

Day of Month	Minutes	No. of Days Elapsed
2 or 16	3.9	1
3 or 17	7.8	2
4 or 18	11.8	3
5 or 19	15.7	4
6 or 20	19.6	5
7 or 21	23.5	6
8 or 22	27.4	7
9 or 23	31.4	8
10 or 24	35.3	9
11 or 25	39.2	10
12 or 26	43.1	11
13 or 27	47.0	12
14 or 28	51.0	13
29	54.9	14
30	58.8	15
31	62.7	16

For the tabular year, two eastern elongations occur on January 14, and two western elongations on July 13.

C. To refer the table to standard time: Add to the tabular quantities four minutes for every degree of longitude the place is west of the standard meridian and subtract when the place is east of the standard meridian.

D. To refer to any other than the tabular latitude between the limits of 25° and 50° North: Add to the time of west elongation 0.10 min. for every degree south of 40° and

*subtract* from the time of west elongation 0.16 min. for every degree north of  $40^\circ$ . For eastern elongations *subtract* 0.10 min. for every degree south of  $40^\circ$ , and *add* 0.16 min. for every degree north of  $40^\circ$ .

E. *To refer to any other than the tabular longitude:* Add 0.16 min. for each  $15^\circ$  east of the ninetieth meridian and subtract 0.16 min. for each  $15^\circ$  west of the ninetieth meridian.

The deduced time of elongation will seldom be in error more than 0.3 min.

**For Evening Observation.** Study of the tables will show that at certain times of the year a choice of methods is offered. Since, however, evening observation is usually most convenient, the following directions have been arranged with that in view. The time limits for these observations, it will be understood, vary somewhat with the latitude.

On the tenth of January observe western elongation at midnight and for each fifteen days thereafter earlier by one hour. This may be done until late March.

From late March to early June, use lower culmination with the help of Delta of Cassiopeia. On April 1st the culmination occurs at 12.37 and after that for each fifteen days earlier by one hour.

From early June to early October use eastern elongation. On June 15th it occurs at 2 A. M.

From early October to middle January use upper culmination with Zeta of the Great Bear.

## SECTION VIII

## THE UNITED STATES PUBLIC LAND SURVEYS

In the original States there is a great variety of system, or lack of system, in the division of land for ownership. Land which has ever been a part of the Public Domain of the United States — and that embraces in general the territory north of the Ohio River and from the Mississippi River west to the Pacific coast — has been surveyed, with small exceptions, under a common system, the so-called “System of Rectangular Surveying.” An account of this, so far as it concerns the woodsman, follows.

Chapter III of the Public Land Laws contains the following sections:

SEC. 99. The public lands shall be divided by north and south lines run according to the true meridian, and by others crossing them at right angles, so as to form townships of six miles square, unless where the line of an Indian reservation, or of tracts of land heretofore surveyed or patented, or the course of navigable rivers, may render this impracticable; and in that case this rule must be departed from no further than such particular circumstances require.

Second. The corners of the townships must be marked with progressive numbers from the beginning; each distance of a mile between such corners must be also distinctly marked with marks different from those of the corners.

Third. The township shall be subdivided into sections, containing, as nearly as may be, six hundred and forty acres each, by running through the same, each way, parallel lines at the end of every two miles; and by making a corner on each of such lines at the end of every mile. The sections shall be numbered, respectively, beginning with the number one in the northeast section, and proceeding west and east alternately through the township with progressive numbers till the thirty-six be completed.

Fourth. The deputy surveyors, respectively, shall cause to be marked on a tree near each corner established in the manner described, and within the section, the number of such section and over it the number of the township within which such section may be.

Fifth. Where the exterior lines of the townships which may be subdivided into sections or half-sections exceed or do not extend six miles, the excess or deficiency shall be specially noted

and added to or deducted from the western and northern ranges of sections or half-sections in such townships, according as the error may be in running the lines from east to west, or from north to south; the sections and half-sections bounded on the northern and western lines of such townships shall be sold as containing only the quantity expressed in the returns and plats, respectively, and all others as containing the complete legal quantity.

Sixth. All lines shall be plainly marked upon trees, and measured with chains, containing two perches of sixteen and one-half feet each, subdivided into twenty-five equal links; and the chain shall be adjusted to a standard to be kept for that purpose.

SEC. 100. The boundaries and contents of the several sections, half-sections, and quarter-sections of the public lands shall be ascertained in conformity with the following principles:

First. All the corners marked in the surveys returned by the surveyor-general shall be established as the proper corners of sections, or subdivisions of sections, which they were intended to designate, and the corners of half and quarter-sections, not marked on the surveys, shall be placed as nearly as possible equidistant from two corners which stand on the same line.

Second. The boundary lines, actually run and marked in the surveys returned by the surveyor-general, shall be established as the proper boundary lines of the sections or subdivisions for which they were intended, and the length of such lines as returned shall be held and considered as the true length thereof. And the boundary lines which have not been actually run and marked shall be ascertained by running straight lines from the established corners to the opposite corresponding corners; but in those portions of the fractional townships, where no such opposite corresponding corners have been or can be fixed, the boundary lines shall be ascertained by running from the established corners due north and south or east and west lines, as the case may be, to the water-course, Indian boundary line, or other external boundary of such fractional township.

Third. Each section or subdivision of section, the contents whereof have been returned by the surveyor-general, shall be held and considered as containing the exact quantity expressed in such return; and the half-sections and quarter-sections, the contents whereof shall not have been thus returned, shall be held and considered as containing the one-half or the one-fourth part, respectively, of the returned contents of the section of which they may make part. (Act of Feb. 11, 1805, and R. S., 2396.)

SEC. 101. In every case of the division of a quarter-section the line for the division thereof shall run north and south, and the corners and contents of half-quarter-sections which may thereafter be sold shall be ascertained in the manner and on the principles directed and prescribed by the section preceding.

In elaboration of the law are the following rules laid down by the Federal Land Office:

24. Existing law requires that in general the public lands of the United States "shall be divided by north and south lines run according to the true meridian, and by others crossing them at right angles so as to form townships six miles square," and that the corners of the townships thus surveyed "must be marked with progressive numbers from the beginning."

Also, that the townships shall be subdivided into thirty-six sections, each of which shall contain 640 acres, as nearly as may be, by a system of two sets of parallel lines, one governed by true meridians and the other by parallels of latitude, the latter intersecting the former at right angles, at intervals of a mile.

25. In the execution of the public surveys under existing law, it is apparent that the requirements that the lines of survey shall conform to true meridians, and that the townships shall be six miles square, taken together, involve a mathematical impossibility due to the convergency of the meridians.

Therefore, to conform the meridional township lines to the true meridians produces townships of a trapezoidal form which do not contain the precise area of 23,040 acres required by law, and which discrepancy increases with the increase in the convergency of the meridians as the surveys attain the higher latitudes.

26. In view of these facts, and under the provisions of Section 2 of the Act of May 18, 1796, that sections of a mile square shall contain 640 acres, as nearly as may be, and also under those of Section 3 of the Act of May 10, 1800, that "in all cases where the exterior lines of the townships, thus to be subdivided into sections and half-sections, shall exceed, or shall not extend six miles, the excess or deficiency shall be specially noted, and added to or deducted from the western or northern ranges of sections or half-sections in such township, according as the error may be in running lines from east to west, or from south to north; the sections and half-sections bounded on the northern and western lines of such townships shall be sold as containing only the quantity expressed in the returns and plats, respectively, and all others as containing the complete legal quantity," the public lands of the United States shall be surveyed under the methods of the system of rectangular surveying, which harmonizes the incompatibilities of the requirements of law and practice, as follows:

*First.* The establishment of a principal meridian conforming to the true meridian, and, at right angles to it, a base line conforming to a parallel of latitude.

*Second.* The establishment of standard parallels conforming to parallels of latitude, initiated from the principal meridian at intervals of 24 miles and extended east and west of the same.

*Third.* The establishment of guide meridians conforming to true meridians, initiated upon the base line and successive standard

parallels at intervals of twenty-four miles, resulting in tracts of land twenty-four miles square, as nearly as may be, which shall be subsequently divided into tracts of land six miles square by two sets of lines, one conforming to true meridians, crossed by others conforming to parallels of latitude at intervals of six miles, containing 23,040 acres, as nearly as may be, and designated townships.

Such townships shall be subdivided into thirty-six tracts, called sections, each of which shall contain 640 acres, as nearly as may be, by two sets of parallel lines, one set parallel to a true meridian and the other conforming to parallels of latitude, mutually intersecting at intervals of one mile and at right angles, as nearly as may be.

27. Any series of contiguous townships or sections situated north and south of each other constitutes a RANGE, while such a series situated in an east and west direction constitutes a TIER.

28. By the terms of the original law and by general practice, section lines were surveyed from south to north and from east to west, in order to uniformly place excess or deficiency of measurement on the north and west sides of the townships. But under modern conditions many cases arise in which a departure from this method is necessary. Where the west or the north boundary is sufficiently correct as to course, to serve as a basis for rectangular subdivision, and the opposite line is defective, the section lines should be run by a reversed method.

For convenience the well-surveyed lines on which subdivisions are to be based will be called governing boundaries of the township.

29. The tiers of townships will be numbered, to the north or south commencing with No. 1, at the base line; and the ranges of the townships, to the east or west, beginning with No. 1, at the principal meridian of the system.

30. The thirty-six sections into which a township is subdivided are numbered, commencing with No. 1 at the northeast angle of the township, and proceeding west to number six, and thence proceeding east to number twelve, and so on, alternately, to number thirty-six in the southeast angle. In all cases of surveys of fractional townships, the sections will bear the same numbers they would have if the township was full; and where doubt arises as to which section numbers should be omitted, the proper section numbers will be used on the side or sides which are governing boundaries, leaving any deficiency to fall on the opposite sides.

31. Standard parallels (formerly called correction lines) shall be established at intervals of twenty-four miles, north and south of the base line, and guide meridians at intervals of twenty-four miles, east and west of the principal meridian; thus confining the errors resulting from convergence of meridians and inaccuracies in measurement within comparatively small areas.

In pursuit of this system, during the course of the public land surveys twenty-four initial points have been established, a **principal meridian** has been run due north and south from each of these, and a **base line** east and west. Each twenty-four miles north and south of the initial point **standard parallels** or **correction lines** have been started on which, as they were run east and west, marks have been left each six miles for the starting of township lines. These are run due north to the next standard parallel; each fourth one being run first and

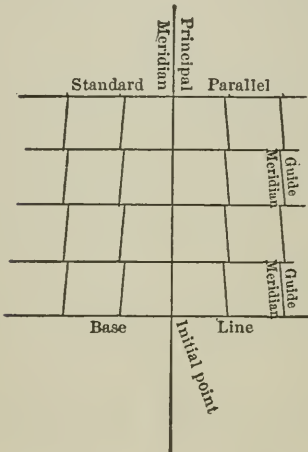

FIRST SUBDIVISION OF LAND

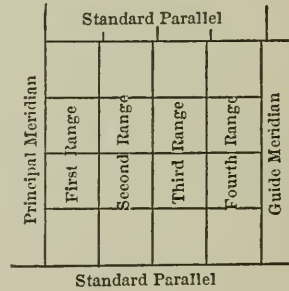

DIVISION INTO TOWNSHIPS

most accurately as a **guide meridian**. On the north and south lines township corners are fixed each six miles by measurement, and each pair of corners is later connected. A township corner is common to four townships except on a standard parallel. There, owing to convergence of meridians, the corners of the townships north are farther from the principal meridian than those of the townships south; farther east or west, as the case may be. The ranges of townships connected with any given initial point are numbered east and west from the principal meridian, and the townships themselves are numbered north and south from the base line. Thus the sixth township north of a base line in the fourth range east of a principal meridian is designated as township 6 north, range 4 east. Each township contains

thirty-six square miles or 23,040 acres, neglecting the narrowing effect of the convergence of the meridians. These relations are indicated clearly in the diagrams.

As the township lines are run, corner marks are left each mile, and the township is divided into thirty-six sections by beginning on the south side at each mile mark and running north, marking each mile or section corner, also each half mile or quarter-section corner. At the north end these lines are made to close on the mile marks left in surveying the north line of the township, with the exception of those on a standard parallel. Here the section lines are run straight out to the parallel, which thus serves as a "correction-line" for the sections as well as for the townships.

N

	6	5	4	3	2	1	
	7	8	9	10	11	12	
	18	17	16	15	14	13	
W	19	20	21	22	23	24	E
	30	29	28	27	26	25	
	31	32	33	34	35	36	

S

SECTIONS IN A TOWNSHIP

N. W. $\frac{1}{4}$  160 acres		N. E. $\frac{1}{4}$  160 acres	
W. $\frac{1}{2}$ of S.W. $\frac{1}{4}$ 80 acres	E. $\frac{1}{2}$ of S.W. $\frac{1}{4}$ 80 acres	N.W. $\frac{1}{4}$ of S.E. $\frac{1}{4}$ 40 acres	S.E. $\frac{1}{4}$ of S.E. $\frac{1}{4}$ 40 acres

SUBDIVISION OF A SECTION

The east and west section lines are run between corresponding corners on the north and south lines, always marking the half-mile or quarter-section point. The effect on area of convergence of meridians is localized in the case of sections, in the first place by chaining the latitudinal township lines always from the east end, thus confining any deficiency of width to the westerly board of sections; in the second place by running the north and south lines not due north exactly, but with a westerly bearing sufficient at one, two, three, four, and five miles from the east line to keep them at equal distances apart throughout their length. Short area is thus confined to

the westerly board of sections in each township when surveys are accurately made. For the same purpose, reduction in the number of irregular units, quarter corners for the north and west tiers of sections are placed exactly forty chains from the interior corners, not at the middle point of the section lines.

The Land Office instructions to surveyors contain several articles on the marking of lines, of which those of interest to the woodsman are quoted on page 24 of this work. Instructions for establishing corners and erecting monuments are also given, but are far too elaborate to be here quoted in full. Corner monuments consist of an object marking the corner itself and its accessories. They are to be set up at the intersection of all the lines noted in the instructions quoted above and at some other points to be mentioned hereafter. Several approved forms of corner monuments are described below. Any one may be used for a township, a section, or a quarter-section corner, the marks upon it indicating what the corner is.

1. Stone with pits and mound of earth.
2. Stone with mound of stone.
3. Stone with bearing trees.
4. Post with pits and mound of earth.
5. Post with bearing trees.
6. Mound of earth, with marked stone or charcoal deposited inside, and stake in pit.
7. Tree with pit and mound of stone.
8. Tree with bearing trees.

Posts of wood and stone and bearing trees have been employed largely as corner monuments in timbered country. The post is set not to exceed one foot out of the ground. At a standard, closing, or quarter corner it is set facing cardinal directions, diagonally at a corner common to four townships or sections. Plain figures and initial letters inscribed on the faces give the location, and this in the case of section corners is also indicated by notches cut in the edges or by grooves on faces. These notches, on account of their durability, are of much service in identi-

fication of section corners. They are placed on the south and east angles of the posts, one for each mile to the township boundary in the given direction. Quarter corners are not notched; township corners are cut six times on each face or angle.

Equally serviceable are the bearing trees. These are blazed rather close to the ground so that the stump can be identified if the tree is cut down. The blazes face the corner, and that on each tree at township or section corners is plainly scribed with the township number and range and that of the section in which it stands. Thus, T 10 S R 6 E S 24 B T (B T for bearing tree).

There are several **exceptions to the system of rectangular surveying** and the regular scheme of monuments resulting therefrom, which it is necessary for the woodsman to understand.

### 1. *Township and Section Corners on Standard Parallels.*

It will be noted after careful reading of the above that township or section corners are common to four townships or sections, with the exception of those on the standard parallels which are four townships apart. Here the corners for the townships north of the parallel are not the same as for those south, but are further from the principal meridian. The former are called "standard corners" and are marked S C in addition to other marks placed on them for their identification. In a similar way the corners relating to land subdivisions lying south of the parallel are marked C C, "closing corner." This last term is also applied in other connections, as when a rectangular survey closes on the boundary of a state, a reservation, or a previous land claim, while occasions for its application have often been found in connection with errors or departures from instructions in the system of surveying.

### 2. *Meander Lines and Corners.*

Ownership of considerable streams or lakes, with the exception of certain "riparian rights," is not conveyed with a land title, the legal limit being high-water mark, or the line at which continuous vegetation ends and the sandy

or muddy shore begins. This line is surveyed in connection with a United States land survey, the process being called "meandering."

At every point where a standard, township, or section line intersects the bank of a navigable stream or other meanderable body of water, corners are established at the time of running these lines. These are called "meander corners." They are always marked MC in addition to any other marks left for their identification.

In the same way, when a line subdividing a section runs into a considerable body of water, a "special meander corner" is established and marked in the same way.

### 3. *Witness Corners and Witness Points.*

A key to the location and meaning of these will be found in the following sections from the "Instructions."

49. Under circumstances where the survey of a township or section line is obstructed by an impassable obstacle, such as a pond, swamp, or marsh (not meanderable), the line will be prolonged across such obstruction by making the necessary right-angle offsets; or, if such proceeding be impracticable, a traverse line will be run, or some proper trigonometrical operation employed to locate the line on the opposite side of the obstruction; and in case the line, either meridional or latitudinal, thus regained, is recovered beyond the intervening obstacle, said line will be surveyed back to the margin of the obstruction.

50. As a guide in alignment and measurement, at each point where the line intersects the margin of an obstacle a witness point will be established, except when such point is less than twenty chains distant from the true point for a legal corner which falls in the obstruction, in which case a witness corner will be established at the intersection.

51. In a case where all the points of intersection with the obstacle to measurement fall more than twenty chains from the proper place for a legal corner in the obstruction, and a witness corner can be placed on the offset line within twenty chains of the inaccessible corner point, such witness corner will be established.

97. The point for a corner falling on a railroad, street, or wagon road, will be perpetuated by a marked stone (charred stake or quart of charcoal), deposited twenty-four inches in the ground, and witnessed by two witness corners, one of which will be established on each limiting line of the highway.

In case the point for any regular corner falls at the intersection of two or more streets or roads, it will be perpetuated by a marked stone (charred stake or quart of charcoal), deposited twenty-four inches in the ground, and witnessed by two witness corners estab-

lished on opposite sides of the corner point, and at the mutual intersections of the lines limiting the roads or streets, as the case may be.

94. When the true point for any corner described in these instructions falls where prevailing conditions would insure its destruction by natural causes, a witness corner will be established in a secure position, on a surveyed line if possible, and within twenty chains of the corner point thus witnessed.

95. A witness corner will bear the same marks that would be placed upon the corner for which it is a witness, and in addition, will have the letters W C (for witness corner) conspicuously displayed above the regular markings on the NE. face when witnessing in township or section corner; such witness corners will be established, in all other respects, like a regular corner, marking bearing trees with the proper numbers for the sections in which they stand.

W C will also be cut into the wood of each bearing tree above the other markings.

98. Witness points will be perpetuated by corners similar to those described for quarter-section corners, with the marking W P (for witness point), in place of  $\frac{1}{4}$ , or  $\frac{1}{4}$  S, as the case may be.

If bearing trees are available as accessories to witness points, each tree will be marked W P B T.

#### 4. *Fractional Sections, Lots, etc.*

A section or quarter-section made of less than full size by water is called "fractional," and in some cases is subdivided according to special rules laid down by the Land Office. The sections on the westerly board of a township, into which, under the plan of survey, shrinkage of area due to convergence of township lines toward the north is crowded, are called fractional as well. Within these sections again, the westerly quarters and forties will be fractional for the same reason. The final subdivisions of irregular area — the system is followed next the north as well as the west line of the townships — are called "lots." In a regular township there are four to each section, numbered from 1 to 4 for each, beginning with the east or north, with seven lots for Section 6. In timbered country, however, they are seldom run out on the ground.

While the above are usual features of the public land surveys, numerous exceptions were made, as for instance in case of a defective east or south boundary in a township,

when subdivision was begun from the opposite side. Somewhat different rules also were in force during the very early surveys. Then in addition irregularities due to the errors of surveying, and these sometimes of an extreme nature, are sometimes found.

PART II  
FOREST MAPS

## PART II. FOREST MAPS

SECTION I. THE TRANSIT . . . . .	73
1. Adjustments . . . . .	73
2. Care of the Transit . . . . .	77
3. Stadia Measurement . . . . .	77
4. Uses of the Transit . . . . .	80
5. Summary . . . . .	87
SECTION II. THE LEVEL . . . . .	87
1. Adjustments . . . . .	88
2. Uses of the level . . . . .	90
SECTION III. THE HAND LEVEL AND CLINOMETER . .	93
SECTION IV. COMPASS AND PACING . . . . .	94
SECTION V. THE TRAVERSE BOARD . . . . .	98
SECTION VI. THE ANEROID BAROMETER . . . . .	103
SECTION VII. METHODS OF MAP MAKING . . . . .	113
1. Introductory . . . . .	113
2. Small Tracts . . . . .	117
3. Large Tracts . . . . .	121
A. With Land already subdivided . . . . .	121
B. Based on Survey of Roads or Streams . . . .	121
C. Subdivision and Survey combined . . . . .	123
D. Western Topography. Use of the Clinometer	129
SECTION VIII. ADVANTAGES OF A MAP SYSTEM . . . .	133

## PART II. FOREST MAPS

### SECTION I

#### THE TRANSIT

THE transit in general engineering work is the most useful and most frequently employed of surveying instruments. It is commonly used to measure horizontal and vertical angles, but, having a magnetic needle, it may be used to take bearings, and, when provided with stadia wires, to measure distances. It may also be used as a levelling instrument. A cut of a transit is shown herewith, also a sectional view through the axis of the same instrument.

The essential parts of an engineer's transit are described below. The **telescope** is attached by means of a **horizontal axis** and **standards** to the upper of two **circular plates**. The two plates move freely on one another, the lower being graduated, while the upper has a **vernier** which allows readings to be made with accuracy. A **compass circle** is also attached to the upper plate. A **clamp** fixes the upper to the lower plate, and a **tangent screw** secures a slow adjusting movement between the two. A similar arrangement is placed between the lower plate and the head of the instrument.

The whole instrument is supported on a **tripod**; **levelling screws** serve with the aid of **cross levels** to fix the plates in a horizontal position; and a finely turned **spindle and socket** arrangement guides the plates in their movement on one another. By means of a **plumb line** attached to the lower end of the spindle the instrument may be set with its axis exactly over any desired point.

#### 1. ADJUSTMENTS OF THE TRANSIT

The object of these adjustments is to cause (1) the instrument to revolve in a horizontal plane; (2) the line of sight to generate a vertical plane when the telescope is

revolved on its axis; (3) the axis of the telescope bubble to be parallel to the line of sight, thus enabling the instrument to be used as a level; (4) the vernier on the vertical

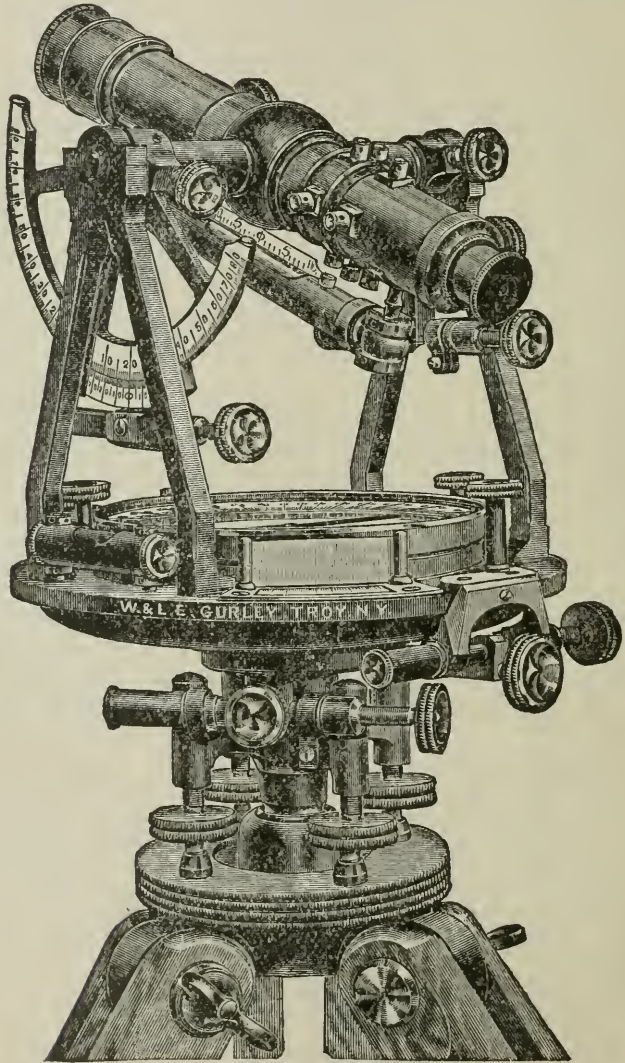

THE TRANSIT

circle to be so adjusted as to give the true altitude of the line of sight. These results may be secured as follows:

- a. To adjust the plate levels so that each is in a plane

perpendicular to the vertical axis of the instrument. Set up the transit and bring the bubbles to the center of their respective tubes. Turn the plate  $180^\circ$  about its vertical axis, and see if the bubbles remain in the center. If they move from the center, turn the capstan-headed screws on the bubble tube until the bubble moves half-way back to the center, or as nearly so as this can be estimated. Each bubble must be adjusted independently. The adjustment should be tested again by releveing and reversing as before, and the process continued until the bubbles remain in the center when reversed. When both levels are adjusted, the bubbles should remain in the center during the entire revolution about the vertical axis.

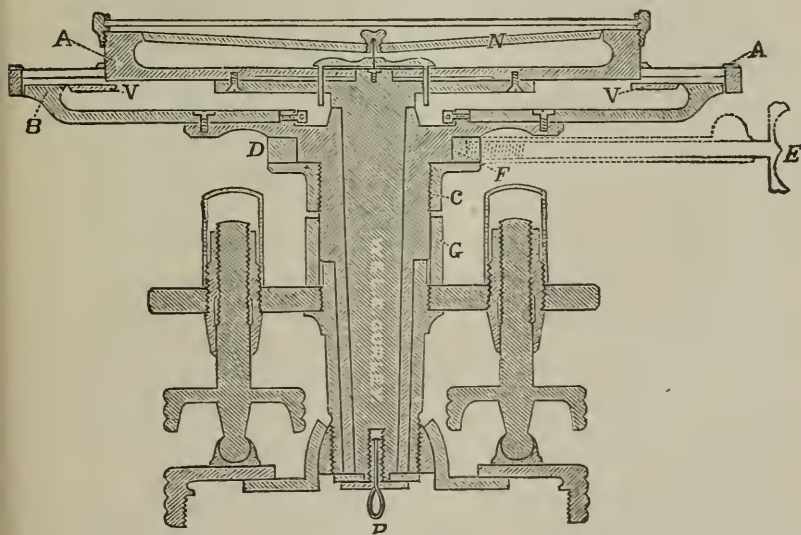

CROSS-SECTION OF THE TRANSIT HEAD

b. To make the line of sight perpendicular to the horizontal axis so that the telescope when revolved will generate a plane. To do this choose open and nearly level ground. Set up the transit carefully over a point *A*, sight accurately at a point *B* at about the same level and 200 or 300 feet away, and clamp both plates. Revolve the telescope and set *C* in line with the vertical cross-hair at about the same distance and elevation. *B*, *A*, and *C* should then be in a straight line. To test this, turn the instrument

about the vertical axis until *B* is again sighted. Clamp the plate, revolve the telescope, and observe if point *C* is in line. If not, set a third point *D* in the new line. Then, to adjust, the cross-hair ring must be moved until the vertical hair appears to have moved to the point *E*, one-fourth the distance from *D* toward *C*, since, in this case, a double reversal has been made.

The cross-hair ring is moved by loosening one of the screws which hold it in the telescope tube and tightening the opposite screw. The process of reversal should be repeated until no further adjustment is required. When finally adjusted, the screws should hold the ring firmly but without straining it.

**c. To make the horizontal axis of the telescope perpendicular to the vertical axis of the instrument, so that the telescope in its revolution will generate a vertical plane.** Set up the instrument and level it carefully. Suspend a fine, smooth plumb line twenty or thirty feet long some twenty feet away from the instrument with a weight on the lower end hanging freely in a pail of water. Set the line of sight carefully on the cord at its upper end. Clamp both plates and bring the telescope down until it reads on the lower end of the cord. If the line of sight does not cut the cord, raise or lower the adjustable end of the horizontal axis until the line of sight does revolve in a vertical plane. Constant attention must be given to the plate bubbles to see that they do not indicate an inclined vertical axis.

If more convenient two points in a vertical line may be used, as points on a building. Set on the top point and turn down to the bottom one, marking it carefully. Revolve both plate and telescope  $180^\circ$  and set again on the bottom point. Raise the telescope again and read on the top point. The second pointing at the top point should correspond with the first. If it does not, adjust as above for half the difference.

**d. To make the telescope bubble parallel to the line of sight.** This adjustment is performed in the same way as for a level, as explained on pages 89 and 90.

**e. To make the vernier of the vertical circle read zero**

when the line of sight is horizontal. Having made the axis of the telescope bubble parallel to the line of sight, bring the bubble into the center of the tube and adjust the vernier of the vertical circle until it reads zero on the limb. If the vernier is not adjustable, the reading in this position is its index error, to be applied to all readings.

## 2. CARE OF THE TRANSIT

The transit should be protected from wet and dust as much as possible, a waterproof bag to cover it being useful for that purpose. The tripod legs should move freely, but not too freely; there should be no lost motion about their shoes or elsewhere. Dust or water should be removed from the glasses by a camel's hair brush or the gentle use of a clean handkerchief; grease may be removed by alcohol. Care should be taken not to strain the parts of the instrument by too great pressure on the screws when using or adjusting it. Before the transit is picked up, the levelling screws should be brought approximately to their mid position, the telescope should be turned vertically and lightly clamped, and the clamp of the lower plate should be loosened. Then, if the instrument strikes anything while being carried from point to point, some part will move easily and severe shock will be avoided.

## 3. STADIA MEASUREMENT

Measurement of distance by stadia is secured by simply sighting with a transit at a graduated rod held on any desired point and noting the space on the rod included between two special cross-hairs set in the focus of the instrument. This is a very rapid method of measurement, being especially handy and effective over broken land; it gives a degree of accuracy sufficient for very many purposes; it allows the computation of the difference in elevation between two points. Thus for many purposes it is the most effective method of survey, and it is coming into general use.

**The Instrument.** A transit intended for stadia work is

provided with two additional horizontal hairs, usually fastened to the same diaphragm as the ordinary cross-hairs, and placed at a known distance apart. The space between these two extra hairs is preferably fixed, but in some transits the diaphragm is so arranged that it can be adjusted. The instrument must also be provided with a level on the telescope and a circle or arc for measuring vertical angles, since the telescope is seldom level when measurements are taken.

**Stadia rods** are usually 10 or 12 feet long. They are plainly painted in such a design as to be read at long distances. Engineers generally use rods graduated to feet and tenths, the hairs cutting off one foot on the rod at a distance of 100 feet. Hundredths of a foot are generally estimated. For use in connection with a land survey it may be more convenient to graduate the rod or adjust the hairs so that one unit will be cut off at a distance of 66 feet or one chain.

**Inclined Sights.** The distance between instrument and rod is measured directly if the sight is taken horizontally, and a vertical angle between them of  $5^\circ$  or less does not so affect the sight as to matter particularly in many kinds of work. If, however, a sight of greater inclination is taken, a reading is obtained that represents a greater distance than the horizontal one between instrument and rod. If for an inclined reading the rod is also inclined, so as to be perpendicular to the line of sight, the reading represents the inclined distance, and the horizontal distance is the cosine of the angle of inclination multiplied by the inclined distance. Similarly, the difference in elevation is the inclined distance multiplied by the sine of the angle.

It is usual, however, and better, to hold the rod plumb, and here the computation of horizontal and vertical elements is not so simple. Tables, however, have been computed which give these elements, horizontal distance and difference of elevation, directly. A compact **stadia table** will be found on page 211 of this work and an example showing the method of its use is given on page 80.

What has been written above needs, however, one qualification. Stadia wires to read truly at all distances

must cut off the unit distance on the rod not at a distance of 100 or of 66 feet, but at a greater distance equal to the distance from the center of the instrument to the objective lens + the distance from the cross-wires to the same lens when focused on a distant object. This correction,  $(f + c)$  as it is called, is about 1 foot in common transits.

In testing the instrument on measured bases, therefore, these should be measured out from the plumb line or center of instrument to the required distance + the constant above described, and for accurate determination of distance the constant should be added to the distance observed. In working out inclined sights from the table this constant may be added to the rod reading before the reductions for horizontal distance and elevation are made.

In the practice of woodsmen, however, work will generally be accurate enough if this constant is neglected, all the more so since this error tends to be compensated by that arising from neglect of the small vertical angles noted above. There are, indeed, a few transits so constructed that no such constant correction as that above stated has to be considered.

**Accuracy.** The accuracy of stadia measurement depends largely on the state of the atmosphere. If that is hazy, or unsteady from the effects of heat, long shots cannot be taken and measurements on shorter distances cannot be accurately obtained. There is furthermore the possibility that the line of sight by the lower hair when passing over very hot ground may be refracted more than the other and thereby give too small a reading. Otherwise than here and above stated the only sources of inaccuracy are due to errors in rod readings which for small errors are as apt to be + as - and so mainly balance one another. Thus while on single shots stadia measurement may be appreciably inaccurate, the relative error decreases with the length of the line run.

In general it may be said that stadia measurement gives satisfactory results for very many purposes, and that it has great advantages in the way of rapidity and cheapness. With good instruments and clear air it can be employed

on distances from one quarter to one third of a mile, giving results which are accurate to within a few feet.

**Example and Reduction of Readings.** 1' on rod cut off at distance of 100'. In computation, correction made for 1' instrumental constant. True horizontal distance and difference of elevation between points both worked out. Height of instrument over station obtained at each setting and center hair for vertical angle read at same height on rod.

Observed			Computed		
Bearing	Rod Reading	Vert. Angle	Distance	Diff. Elev.	Elev.
N. 5° E.	2.00'	+ 1° 30'	200.86'	+ 5.27'	5.27'
N. 5° E.	1.80'	+ 4° 10'	179.84'	+ 13.12'	18.39'
N. 5° E.	1.05'	+ 8°	103.94'	+ 14.61'	33.00'
N. 5° E.	1.50'	- 30'	150.98'	- 1.31'	31.69'
			635.62'		31.69'

*Computation.* First shot, with v. a. of 1° 30', rod reading 2.00'. Add .01' for instrumental constant, making 2.01', for corrected rod reading. From table the horizontal distance for 1' rod reading is found to be 99.93' the difference of elevation 2.62'. For 2.01' rod reading the elements are  $99.93 \times 2.01$  and  $2.62 \times 2.01$  or 200.86' and 5.27', as above.

Second shot,  $1.80 + .01 = 1.81$ , corrected rod reading.

For v. a. 4° 10' and rod reading 1', horizontal distance 99.47 and diff. elev. 7.25 are found in the tables.  $99.47 \times 1.81$  and  $7.25 \times 1.81 = 179.84$  and 13.12.

Similarly for succeeding shots.

#### 4. USES OF THE TRANSIT

**To Take the Bearing of a Line.** Set up over the first point, level the instrument, free the needle, and turn the telescope toward the other point. Read the bearing in the same way as with a compass.

When set up on the forward one of two points, exactly the same bearing may be read as if the instrument were

set up on the rear point, if the telescope is revolved before the pointing is made and the bearing taken.

**To Measure a Horizontal Angle.** Set up the instrument, center it by means of the plumb line over the vertex of the angle required, set the zeros of the two plates together, clamp them, and turn the telescope toward one of the points, making the final adjustment by means of the lower tangent screw. Then loosen the upper clamp, turn toward the other point, clamp again, and set finally by the upper tangent screw. Read the angle turned by means of the vernier. If the instrument has two verniers, both may be read and the average taken.

**Measurement by Repetition.** A more accurate measurement may be had by turning the angle several times, taking the final reading, and dividing it by the number of times the angle has been turned. If the final reading is about  $360^\circ$ , possible errors in the graduation of the instrument will have no effect on the angle read, and if later the telescope is inverted and the angle turned in the opposite direction from the first turning, other sources of error will have been eliminated. The exact program for an observation of this kind is as follows:

*a.* Telescope direct.<sup>1</sup>

1. Clamp plates on zeros, and set on left station. Clamp below.

2. Unclamp above and set on right station.

3. Unclamp below and set on left station.

4. Unclamp above and set on right station.

Continue until the desired number of turnings have been made, when the final reading may be taken.

*b.* Telescope inverted.

1. Clamp plates on zeros and set on right station. Clamp below.

2. Unclamp above and set on left station.

3. Unclamp below and set on right station.

4. Unclamp above and set on left station.

Continue for the same number of turnings as before

<sup>1</sup> That is, with the level tube underneath the telescope.

and read the final angle. If the instrument has two verniers both should be read. It is customary to record the reading after turning the angle once, as a check on the repeated reading. The true reading is the average of the values obtained for the angle with telescope direct and telescope inverted.

**To Prolong a Straight Line.** Set up the instrument over the forward point and sight the telescope on the rear one. Set both clamps, revolve the telescope on its axis, and set a new point as far ahead as convenient or desired.

**More Accurately.** With the telescope in its natural position, turn on the rear point, clamp, revolve the telescope as above, and set a stake and tack at the forward pointing. Then, leaving the telescope inverted as it is, swing the plates around half a circle and set on the rear point again. Revolve the telescope, and again sight at the forward point. If the two pointings ahead do not coincide, set a tack half-way between the two and it will be in the line desired.

**To Measure a Vertical Angle.** For this purpose the vertical circle must be adjusted so as to read zero when the telescope is level, or, if it is not adjustable, the error of its reading must be obtained, as explained under adjustments of the transit. Then the angle of elevation or depression to any point may be measured by sighting the telescope upon it and reading the vertical angle by means of the vertical circle and its vernier.

**To Survey a Piece of Ground with the Transit.** Set up on the initial point of the survey, turn to the second point, read the bearing of the line, recording it for a check on later angles, and measure the line. Set up over the second point, set the two plates to read zero, and clamp them together; then turn the telescope at a rod held vertical and carefully centered over the first point. Set the lower clamp and loosen the upper one, swing the telescope with the upper plate around until the third point is sighted, and read the angle so turned. Read the bearing for a check, and measure the line. Proceed in this way until all the angles have been turned and all the sides measured. **Interior angles** should always be read, though

they may be more than 180°. The magnetic bearings may be used to figure out the angles as a check on measurement; they also help to locate an error if one exists, but a more accurate check is the sum of all the angles which should equal twice as many right angles less four as the figure has sides.

Computed bearings are worked out by applying the angle measurements to the bearing of the first line. Computed, not observed, bearings should be used for plotting or for computing traverse. Notes may be kept as follows:

<i>Notes of Survey of Field</i>					
<i>Sta.</i>	<i>Int. Angle</i>	<i>Observed Bearing</i>	<i>Computed Bearing</i>	<i>Distance</i>	
0		N 81° E	N 81° E	518.63 ft.	
1	269° 19'	N 8° 15' W	N 8° 19' W	48.19 "	
2	95° 52'	N 75° 45' E	N 75° 49' E	300.53 "	
3	85° 12'	S 9° 30' E	S 9° 23' E	183.60 "	
4	91° 28'	S 79° 15' W	S 79° 9' W	819.96 "	
5	86° 56'	N 7° 45' W	N 7° 47' W	134.85 "	
0	91° 13'	N 81° E			

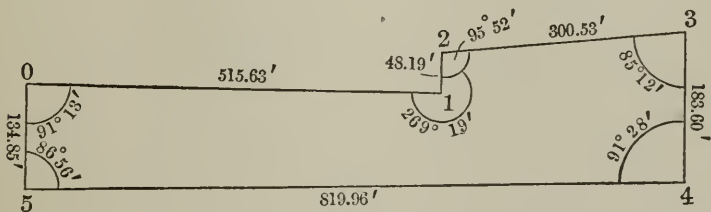

SKETCH OF SURVEY

Instead of interior angles, **deflection angles** may be read, a deflection angle being the angle which any course makes with the prolongation of the one preceding. To get this, after the instrument has been turned on the rear point, revolve the telescope on its axis and turn to the point ahead. The deflection must be recorded as right or left,

along with the amount of the deflection. Notes may be kept as follows:

Instr. at	Deflection Angle	Observed Bearing	Computed Bearing	Distance
0		N. 81° E.	N. 81° E.	518.63 ft.
1	89° 19' L.	N. 8° 15' W.	N. 8° 19' W.	48.19 ft.
2	84° 8' R.	N. 75° 45' E.	N. 75° 49' E.	300.53 ft.

In any case, a sketch kept on the right-hand page of the note book will be an aid to clearness. The whole survey, indeed, may be recorded in that form.

**A Survey or Traverse by Azimuths.** Azimuth is the angle which a line forms with the meridian, or with any other line which is selected as a basis. It is similar to bearing, but is measured in one direction, commonly from south around through west, north, and east up to 360°, and transits are commonly graduated so as to be read directly in this way. The method of work is as follows:

Set up on the initial point of the survey, set the zeros of the two plates together, clamp them, and turn until the telescope points south, as shown by the needle. Clamp below, loosen above, and point the telescope at the second point of the survey, recording the angular reading, and the bearing for a check upon it. Clamp above and loosen below. Measure the line.

Set up over the second point, revolve the telescope, and turn on the first point, making sure not to start the upper clamp at any time during the process. Clamp below; then revolve the telescope into its natural position, loosen above, and turn on the third point of the survey. The azimuth of this line may now be read off the plate and bearing by the needle for a check. Measure the second line. Proceed in this way until the survey is completed. If the survey is a closed one, when the transit is finally set up again at the initial point, the azimuth of the first line should be the same as it was at the beginning.

Notes may be kept as follows:

Line	Azimuth	Bearing	Distance
A — B	162° 12' 30"	N. 17° 45' W.	6.40 ch.
B — C	223° 30'	N. 43° 30' E.	7.25 ch.
C — D	280° 25'	S. 79° 30' E.	4.92 ch.
D — E	5° 43' 30"	S. 5° 45' W.	6.10 ch.

**Caution.** In transit surveying, where angles are read, each line is referred to the one that goes before, and in consequence an error in reading one angle is perpetuated throughout the survey. Further than that, some of the errors arising from lack of adjustment of the instrument are multiplying errors, increasing as the work proceeds, and unless every precaution is taken they may, though individually small, mount up to a very considerable size in the course of a survey.

With compass surveying, on the other hand, though bearings cannot be read with great exactness and single angles are not so accurately determined as with the transit, yet errors have not the same opportunity to accumulate because each course in the survey is referred anew to the meridian.

The man who is not in constant practice, therefore, will be likely to find that he attains better results with the needle than by turning angles, and in that case, unless the telescope is wanted for stadia measurements, the compass is the instrument to use. The matter of cost is, in woods conditions, strongly on the side of the compass, for it is usually expensive to cut away for the long, clear sights requisite to the running of a reliable transit line.

Typical examples of stadia surveys such as the woodsman may have occasion to perform are as follows:

**Stadia Survey of a Pond** as carried out on the ice. The needle was relied on in this case, but it will readily be understood that angles might be read instead of bearings and the survey so rendered independent of the magnetic needle. If the survey were to be made in summer, points

and islands would have to be used for observing stations, and it might be necessary to do a good deal of traversing of the shore.

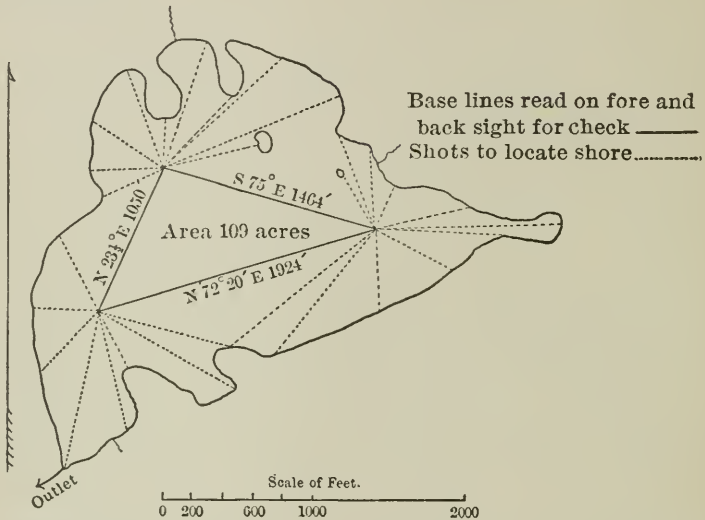

**Stadia Survey of Road.** 1 foot on rod cut off at distance of one chain. Instrument set up at alternate stations only, except where a check on local attraction of the needle is desired. Vertical angles of less than 5° neglected as having no material effect on horizontal distance.

					Jan. 10, 1907	W.W.Cook, Inst. H.O.Colton Rod.
Line as read	Bearing	Rod. Reading	V. A.	Dist	Remarks	
0-1	N 80° E	2.30		2.30 ch	Sta. 0 on West line of tract 1 mile	
1-0	N 80° 5' E	2.30	Read for Check on needle.		56.5 chains So. on it as Shown by	
1-2	S 78° 30' E	6.16		6.16 ch	Survey of boundary	
3-2	N 89° 15' E	5.25		5.25 "	These courses along South slope	
3-4	N 41° E	1.10	+ 5 1/2°	1.09 "	onto shoulder coming from NE	
5-4	N 25° 15' E	6.52	- 2°	6.52 "		
5-6	N 10° E	5.30		5.30 "		
7-6	N	6.10		6.10 "		
7-8	N 10° 15' E	8.15		8.15 "	2.45 on this course brook crosses	
9-8	N 35° 30' E	3.50		3.50 "	to East.	
9-10	N 10° 30' W	9.50		9.50 "		
10-9	N 10° 30' W				Test of needle	

## 5. SUMMARY

The transit of late years has gained a considerable field of use among working foresters for map making and other purposes. The instrument has for woods work great advantages over the plane table in that it is more portable, is less liable to accident, and is not so easily driven off the field by bad weather.

The uses for it, present and prospective, are as follows:

(1) It is the instrument for land surveys when great accuracy is required or the needle is seriously disturbed. When it is so employed the stadia wires in some cases afford the most effective means of distance measurement.

(2) It may be used as a level in dam and road building or for topographic purposes.

(3) Two men using transit and stadia can traverse roads, streams, or lake shores very rapidly, using the needle and, except for a check on local attraction, setting up the instrument on alternate points only.

(4) Uses (2) and (3) may be combined, allowing a traverse and a profile to be run at the same time by the same party.

(5) A skeleton of accurately run lines, embracing both horizontal and vertical angles, may be made the basis of topographic surveys, and the method is in fact highly serviceable in some kinds of country.

(6) With its various capacities again utilized, the transit is sometimes employed to work out the detail of small tracts requiring great accuracy.

## SECTION II

## THE LEVEL

The engineer's level consists of a telescopic line of sight joined to a spirit level, the whole properly supported, and revolving on a vertical axis. The outside parts of the frame which support the telescope are called the wyes, and the

corresponding bearings on the telescope tube, the pivot rings. The telescope can be lifted out of the wyes by lifting up the clips over the rings. The attached bubble enables the line of sight in the telescope to be brought into a horizontal position.

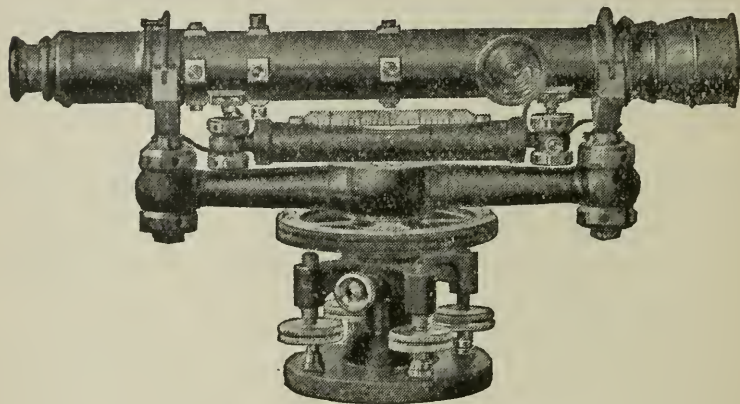

THE LEVEL

## 1. ADJUSTMENTS OF THE LEVEL

(a.) **Make the line of sight coincide with the axis of the pivot rings.** Pull out the pins which hold the clips on the telescope and turn the clips back so that the telescope is free to turn in the wyes. Sight the intersection of the cross-hairs at some well-defined point. Then rotate the telescope  $180^\circ$  in the wyes, so that the bubble tube is above the telescope. The intersection of the cross-hairs should still be on the point. If not, move the horizontal cross-hair half-way back to its first position by means of the upper and lower adjusting screws of the cross-hair ring. Then move the vertical cross-hair half-way back to its first position by the other pair of screws. Repeat the test until the adjustment is perfect.

(b.) **Place the line of sight and the bubble in the same vertical plane.** Bring the bubble to the center of the tube. Revolve the telescope a few degrees in the wyes and note the action of the bubble. If it runs to one end, bring the tube under the axis of the telescope by means of the lateral

adjusting screws. When the two axes are in the same plane, the bubble will remain in the center while the telescope is revolving.

(c.) **Make the level tube parallel to the line of sight.** This may be done in two ways. The first or **indirect method** is as follows:

Clamp the instrument over a pair of levelling screws; then bring the bubble to the center of the tube, lift the telescope out of the wyes, turn it end for end, and set it down in the wyes again. The eye end now is where the objective was originally. This operation must be performed with the greatest care, as the slightest jar of the instrument will vitiate the result. If the bubble returns to the center of the tube the axis of the tube is in the correct position. If it does not return to the center, the end of the tube provided with the vertical adjustment should be moved until the bubble moves half-way back to the center. This test must be repeated to make sure that the movement is due to defective adjustment and not to the jarring of the instrument.

For the second, the **direct or peg adjustment**, select the points *A* and *B*, say 200 feet apart. The distance need not be measured. Set up the level close to *A* so that when the rod is held upon it the eyepiece of the telescope will swing within about half an inch of its face. Bring the bubble to the middle of the tube and looking through the telescope *wrong end to*, put a pencil mark on the rod at the center of the small field of view. Note the rod reading thus obtained. Then turn the telescope toward *B* and take a rod reading in the usual way, making sure that the bubble is in the middle of the tube. The difference between these two rod readings is the difference in elevation of the two points + or - the error of adjustment. Next take the level to *B* and repeat the above operation. The result here gained is the difference in elevation - or + the error of adjustment, and the mean of the two results is the difference of elevation between points *A* and *B*. Now, knowing the difference between *A* and *B* and the height of the instrument above *B*, the rod reading at *A* which will bring the target on the same level as the instrument may be computed. With the horizontal cross-hair on the target, the

adjustable end of the level tube is raised or lowered by means of the adjusting screws until the bubble is in the middle. The adjustment should then be correct, but it will be well to test it.

#### EXAMPLE

Instrument at A

Rod reading on A	= 4.062
Rod reading on B	= 5.129
Diff. elev. of A and B	= 1.067

Instrument at B

Rod reading on B	= 5.076
Rod reading on A	= 4.127
Diff. elev. of B and A	= 0.949

Mean of the two results =  $\frac{1.067 + 0.949}{2} = 1.008$ , true diff. in elev.

Instrument is now 5.076 above B.

Rod reading at A should be  $5.076 - 1.008 = 4.068$  to give a level sight.

This method of adjustment may be used for the transit with this difference — that instead of adjusting the level tube to the line of sight, the level tube is first made horizontal and then the line of sight is made parallel with it by adjusting the cross-hair. The same is true of a dumpy-level.

**(d.) Make the axis of the level tube perpendicular to the vertical axis of the instrument.**

Bring the two clips down over the telescope and fasten them. Level the instrument, bring the bubble precisely to the middle of the tube over one set of levelling screws, and then turn the telescope  $180^\circ$  about the vertical axis. If the bubble moves from the center, bring it half-way back by means of the adjusting screws at the foot of one of the wye supports.

Since the bubble is brought to the center of the tube each time a rod reading is taken, this last adjustment in no way affects the accuracy of levelling work, but it is a convenience and a saving of time.

## 2. USE OF THE LEVEL

Levelling is employed to get the difference in elevation between points. With the level set up and the rod held on

a point whose elevation is known or assumed, the reading that is obtained is called a (+) or **backsight**. Similarly, a reading on a point ahead or unknown is called a (-) or **foresight**. A point occupied by the rod in this way, but not recorded or used further, is called a **turning-point**. When two points have been connected by a series of readings of this kind, the sum of the backsights minus the sum of the foresights gives the difference in elevation. If the backsights are greater, the second point is the higher of the two. If the foresights are greater, it is the lower. A brief set of notes is given and worked out illustrating this matter. Work of this kind is called **differential levelling**.

B.S.	F.S.	Remarks
9.52'	4.45'	B.S. onto B.M. of previous survey.
10.12'	3.27'	
8.56'	1.01'	
7.40'	5.71'	
3.65'	8.62'	
39.25'	23.06'	F.S. to pond level required.
23.06'		
16.19'		Pond is above B. M.

When levelling is employed to get the elevation of a large number of points in a region, several or many foresights may be taken from one position of the instrument. It is customary then to note the **height of instrument**, and the elevation of any point observed will be that height less the foresight to the point.

A **benchmark** is a point whose elevation has been determined and which is marked and left for reference. It is noted B. M. in level notes.

The following set of notes illustrates those commonly kept in running profiles of a road or railway. The form may be easily modified for any other class of work.

**Summary.** Levelling is comparatively simple work. Even though a level is somewhat out of adjustment, accu-

rate results may nevertheless be had by taking backward and forward sights of equal length, and this check it is easy

<i>Profile of Park Road</i>					<i>Sept. 10, 1907</i> <small>{ Gould &amp; Martin, Rod</small>	
<i>Sta.</i>	<i>B.S.</i>	<i>H.I.</i>	<i>F.S.</i>	<i>Elev.</i>	<i>B.M. &amp; I.P. Elev.</i>	<i>Description</i>
<i>B.M.<sub>3</sub></i>	<i>12.23</i>	<i>34.98</i>			<i>22.75</i>	
<i>0</i>			<i>9.8</i>	<i>25.2</i>		
<i>1</i>			<i>6.6</i>	<i>28.4</i>		
<i>2</i>			<i>3.0</i>	<i>32.0</i>		
<i>T.P.<sub>1</sub></i>			<i>1.43</i>		<i>33.55</i>	<i>On stump</i>
<i>"</i>	<i>11.18</i>	<i>44.73</i>				
<i>3</i>			<i>6.1</i>	<i>38.6</i>		
<i>+65'</i>			<i>2.7</i>	<i>42.0</i>		
<i>4</i>			<i>3.7</i>	<i>41.0</i>		
<i>5</i>			<i>5.2</i>	<i>39.5</i>		
<i>6</i>			<i>11.2</i>	<i>33.5</i>		
<i>T.P.<sub>2</sub></i>			<i>5.62</i>		<i>39.11</i>	<i>Boulder</i>
<i>"</i>	<i>3.48</i>	<i>42.59</i>				
<i>7</i>			<i>10.2</i>	<i>32.4</i>		

to secure by pacing. It is important that the rod should be held plumb during the levelling operation. This position is secured by careful attention on the part of the rodman and by waving the rod slightly. The length of sight varies with the instrument, the condition of the air, and the accuracy desired. About 300 feet is stated to be in general the best length on the score of accuracy, but speed will often require that much longer shots be taken. In accurate work, it should be remembered that error may be introduced by the slightest causes, such as disturbance of the tripod.

Levelling is employed by woodsmen in constructing dams and ascertaining the area of flowage, in laying out roads and railroads, and for the basis of topographic work.

For these uses a light and cheap form of the level, sometimes called the architect's level, costing about half as much as one adapted to railway work, is commonly sufficient.

### SECTION III

#### COMBINED HAND LEVEL AND CLINOMETER

A pocket instrument capable of a great variety of uses is shown in the accompanying figure. The eye is placed at a peep hole at the right end (*a*) of the main tube. The cross-wire is over (*b*) in the figure, and beside it, occupying half the orifice of the tube, is a mirror set at

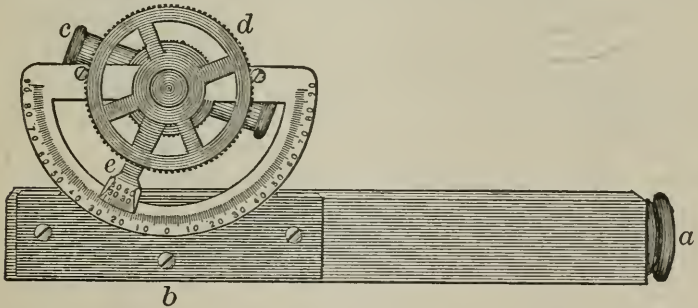

an angle of  $45^\circ$ . Directly over the wire and mirror is a spirit tube (*c*), shown inclined in the figure. It is fixed to the milled wheel (*d*) which turns it, and the graduated arm (*e*), which serves to set the bubble parallel to the line of sight of the instrument, or to read the angle of inclination between them. When the bubble is in the center of the tube, the mirror below reflects it side by side with the cross-wire back through the peep hole.

This instrument is largely used by northwestern lumbermen in laying out roads, locating dams, etc., and it ought to be in the outfit of every woodsman. To use it as a hand level the zeros of the graduated arm and the scale must first be set together. The observer then sights an object through the tube, which he brings to a level by the bubble reflected in the mirror. He may then place himself on a level with the object by sighting at it directly,

or, if difference in elevation is required, a pole or level rod may be used to measure the amount.

The instrument may be used to find the difference in elevation between any two points without the use of a level rod. To do this the observer begins at the lower point, and, after levelling the instrument, sights in the desired direction and notes the point on the ground ahead intersected by the cross-wire. He then advances to that point and repeats the operation, and so moves on up the grade until the upper point is reached. As between every two observations he has advanced to a height equal to the distance from the ground to his eye, the height of the hill will be the product of that distance by the number of sights taken.

The instrument may also be used as a clinometer to measure slope. To do this the observer sights along the slope parallel to the ground, and then uses the hand wheel to turn the level tube until the bubble shows it is level. The measuring arm, turning with the wheel and the level, sweeps the scale and indicates the slope in degrees, or in per cents, according as the instrument is graduated.

In the same way, and with the aid of a table of tangents, one may use the instrument to obtain the height of a tree or a hill. This process is explained and illustrated on page 166.

For an improved form and more complicated use of the instrument, see pages 130-131.

## SECTION IV

### COMPASS AND PACING

The **staff compass**, with folding sights, cross levels, and a needle from  $2\frac{1}{2}$  to 4 inches long, is familiar to most woodsmen. It is a very compact and practical instrument, has long been employed for retracing lines, and of late years, as forest lands have come to be handled more systematically, has attained a great extent and variety of uses. It has also been constructed in a variety of forms, combined with other instruments in some cases. The form

shown in illustration is the pattern of the U. S. Forest Service. The base is flat so that the instrument may be used to orient a plane table — it is square also and graduated on its edges with a protractor and two scales for drafting purposes; declination can be set off by means of a vernier; inside the box a pendulum is fitted and the staff mountings permit of turning the instrument and holding it edgewise while employed as a level or clinometer.

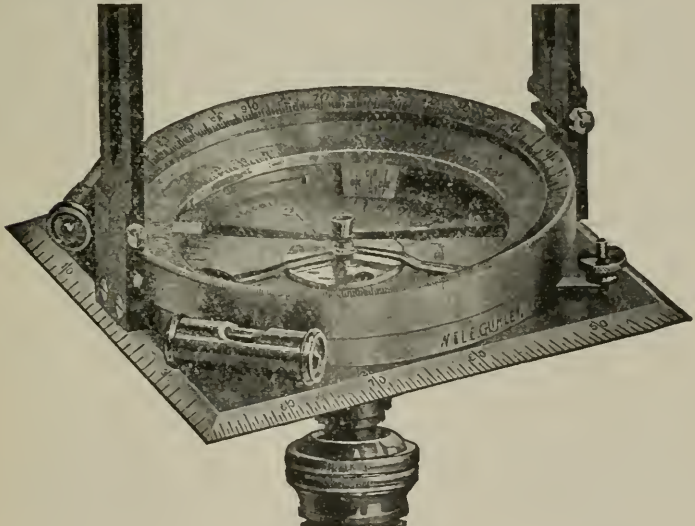

STAFF COMPASS

A main use for the staff compass in topographical and timber work is for making foot traverses, a purpose for which it is thoroughly adapted. The common **pocket compass** with needle  $1\frac{1}{2}$  to 2 inches long, indeed, may be used for the same purpose, and when it enables a man to travel a mile with only  $1^\circ$  or  $2^\circ$  of angular swing, as it will do if carefully used, it deserves to be called a surveying instrument.

**Pacing.** The pace has been long used as a check on short distances, but the real capacity of pacing as a method of measurement has only recently been developed. It is of special value to woodsmen who must travel their country over in any case, and who by a little extra pains taken in this direction can bring out much valuable infor-

mation. As against chaining, pacing has the advantage of cheapness, it can be done by one man alone, and its accuracy is frequently quite sufficient.

The natural gait of the woodsman should be tested on measured lines and in pacing for distance he should always walk at his natural gait, not try to take a three-foot stride. The slope of the ground, if it is considerable, affects the length of step; the step is shortened whether one goes up or down hill.

This matter has been investigated accurately and the results of one extensive test are given in the table below,

INFLUENCE OF SLOPE ON LENGTH OF PACE AS TESTED  
ON MOUNTAIN TRAILS

Slope	Length of step ascending	Length of step descending
0°	2.53	2.53
5°	2.30	2.43
10°	2.03	2.36
15°	1.84	2.30
20°	1.64	2.20
25°	1.48	1.97
30°	1.25	1.64

but for practical work it is better for each man to train himself on measured distances and learn to discount on slopes by experience and the sense that he develops. Similarly, rough bottom and bushes have an effect on the pace. This is best dealt with in the same way.

Harder perhaps to allow for, are the errors arising from a man's own condition. A man steps shorter when travelling slowly than when going at a good rate; he steps shorter when tired unless he forces himself to the work; he is not sure of himself in the morning or after a longer rest until he gets "into his gait"; he has his "off times" when nothing seems to go right. Keeping the count also is a source of frequent error. Woods travel is too uneven

as a rule to allow a pedometer to be employed. Some men register double paces. Others count up to a hundred in the head and take down the hundreds on a "clicker," in a note book, or by breaking an elbow in a tough twig carried in the teeth or hand.

**Accuracy.** With all its limitations, pacing is a very serviceable means of measurement and a man who has duly trained himself can get very good results. Johnson's "Surveying" says, that when a man's gait has been standardized and on the work he walks at a constant rate, "distances can be determined by pedometer or by counting the paces to within 2 per cent of the truth." That refers, without doubt, to open land. In woods work too there

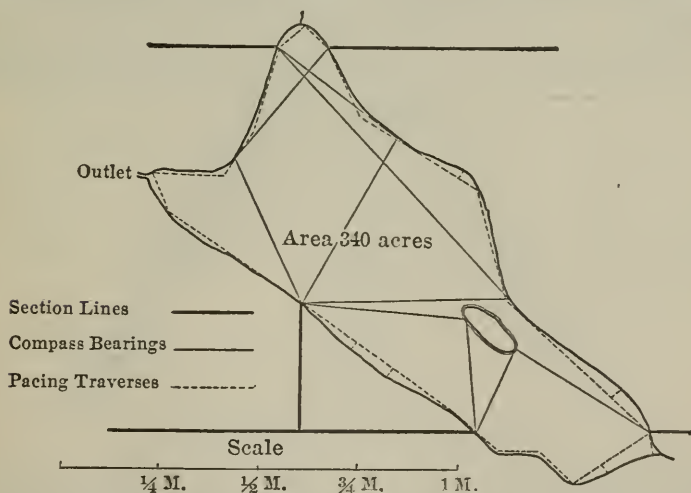

POND SURVEYED FROM SECTION LINES BY CROSS BEARINGS AND THE COMPASS AND PACING METHOD

are many men who can be depended on for results as close as that, but errors up to 5 per cent in a straight mile on uneven land is for the writer the usual standard of work. This is not serious. When the error is distributed over the mile by plotting, the utmost probable error in the location of any point is not over 25 yards.

**Uses of the Method.** (1) The staff compass is largely used in retracing old lines. Pacing may well be employed with it as a means of finding blind marks and corners, for this purpose replacing the chain.

(2) In timber estimating, the area of waste lands, heavy bodies of timber, etc., can often be obtained quickly and with a fair degree of accuracy by this method, and these facts often furnish very great help in securing a close estimate.

(3) The compass and pacing method is the cheapest for mapping roads, streams, ponds, and other topographic details in wooded country. For a real map, however, this method of survey should not cover too long distances, but should tie into more accurate work.

(4) Compass and pacing may be used to get a reconnaissance map of a region of any size, using a road or any other avenue of travel that passes through it. Not only the line of travel may be mapped, but the hills and other features of the country that can be seen. Cross bearings with the compass will locate them in the horizontal position, and the clinometer will serve to get their height.

Specimen notes illustrating this method of work combined with the use of the aneroid barometer for determining height, and a diagram showing how it is made to contribute to the production of a topographic map will be found on pages 130-132.

## SECTION V

### THE TRAVERSE BOARD

The plane table in its simplest form is called a traverse board, and consists of a square board without levels mounted on a tripod. On this board a sheet of paper is pinned, and the map is developed in the field. A compass needle set into the edge of the board serves to "orient" it, or, in other words, to fix one edge always in the north and south position. A brass ruler with vertical sights attached serves both to sight with and to draw lines and scale off distances on the map. It is called an alidade.

A simple use for the board is to traverse a road, a stream, or the shore of a pond. Suppose, for instance, it is desired to survey a stream on the ice in winter, and a point

on it is known by the crossing of a section line. The instrument should be set up at the known point, with one edge of the board set north and south as shown by the needle. A point is then chosen on the sheet to represent the one occupied on the ground, the edge of the ruler is swung about it until the sights range toward the second point to be occupied, say the next turn of the stream, and

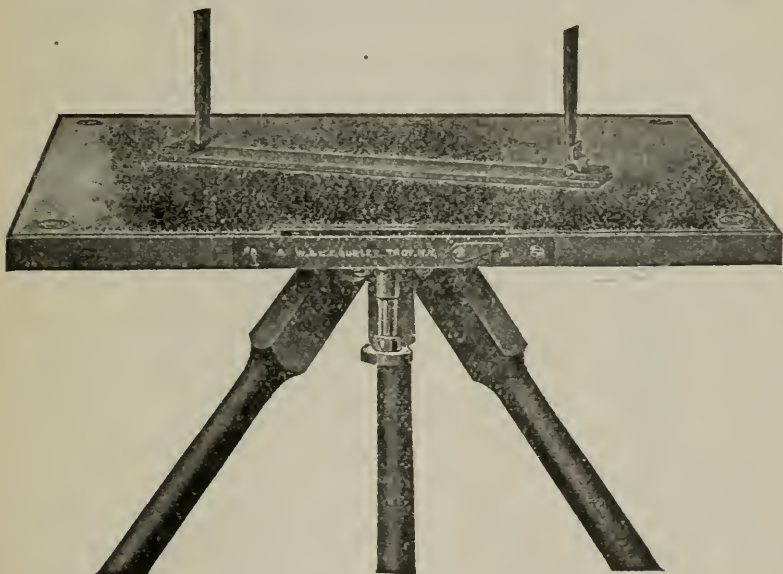

TRAVERSE BOARD

a line is drawn in its direction. The distance between the two points is then chained or paced, and when this has been scaled off a second point on the map is obtained. The board must then be set up at the new point and oriented as before, when, the ruler being swung about the new point, a ray may be drawn from it to a third, and so on. Little difficulty will be experienced by one who understands compass surveying in working this instrument. A point on the sheet always represents the point occupied, and that is always the point to work from. The map is carried to completion right in the field and that, as regards both cost and accuracy, constitutes the advantage of the method.

Another method of working is by **intersections**. For this, it is necessary to have two known points or a measured base. The instrument is set up at one of the known points, and, the alidade being pointed at the other, a line

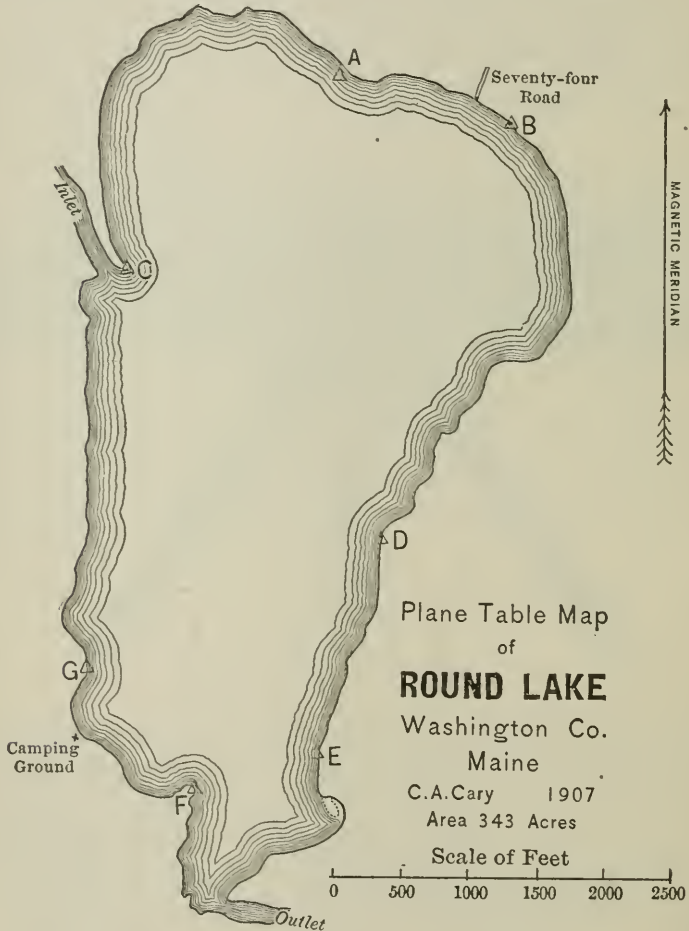

is drawn and the known distance scaled off upon it. Then, from that end of the base line representing the point occupied, rays are drawn in the direction of other well-defined objects on the shore which it will be desirable to locate. Flags may be used to define them, but natural objects will often suffice. The instrument is then

taken to the other known point, and set up by the range back to the first. Then swinging the ruler about the second point located on the sheet, the surveyor draws rays from this to the same objects as before. The intersection of pairs of rays directed toward the same object in the field fixes that point upon the map. This is done directly and graphically, no computation or reduction being required.

More complicated forms of the instrument, telescopic alidades, the application of the vertical angle, etc., need not be here discussed, as they are hardly likely to be employed by other than specialists. It seems likely, however, that among a large class of foresters and woodsmen this simple form of the plane table will find general use.

The following survey of a small lake made with the traverse board involves a somewhat more complicated use of the instrument than that described above. This particular piece of work took the time of two men for two days, but on the ice it could have been done more quickly. The steps in making the survey were as follows:

1. Base line  $AB$  measured, the longest straight line that could be had on the shore and in wading depth of water. Flags set up at its ends and at  $C, D, E, F,$  and  $G,$  prominent points on the shore visible from both ends of the base line.

2. Plane table set up at  $A$  as oriented by the needle. Point  $a$  selected on the paper, line drawn from it in direction of  $B$  and  $ab$  measured to scale. Rays  $ac, ad, ae, af,$   $ag$  drawn in direction of  $C, D, E, F,$  and  $G.$

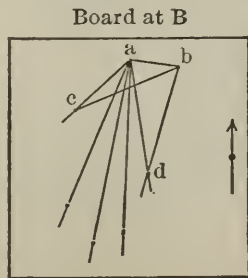
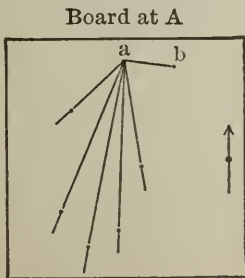

3. Table set up at  $B,$  oriented by ranging  $ba$  at  $A$  and checked by the needle. Rays drawn from  $b$  toward  $C$  and

*D*. These where they intersect corresponding rays from *a* fix points *c* and *d*. Rays also drawn toward *E*, *F*, and *G*, but the angles made with the corresponding rays from *a* are so small that these points are not given a good location.

4. Board taken to *C* and oriented by *A* and *B*. Check ray drawn to *d*. Rays toward *E*, *F*, and *G*, intersecting similar rays from *a*, fix *e*, *f*, and *g*.

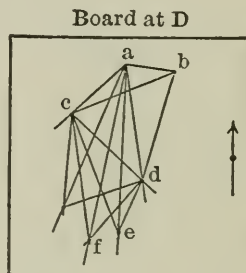
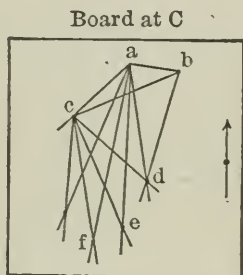

5. Board taken to *D* and similar process performed for a check. *E*, *F*, and *G* may also be checked with one another.

6. Fix other points on the shore such as prominent rocks or trees.

(a) By intersecting rays from any two of the primary points in the same manner as these were fixed.

(b) By drawing a ray from one of the primary points as *c* toward any object as *X*, setting up at *X*, using *c x* to orient by, and then fixing *x* by a ray brought back in the range *A a* until it cuts *c x*.

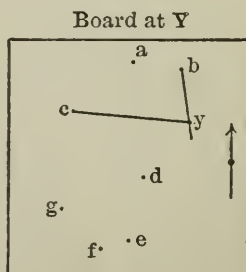
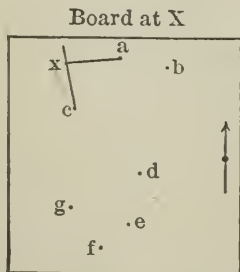

(c) By setting up the board on any desired point on the shore as *Y*, oriented by the needle, and ranging back from

any two flags or fixed points, through the corresponding points on paper, to an intersection which will fix the point occupied.

7. Fill in the shore line as the other work progresses, whatever at the time is nearest the instrument, by traverses, sketching, etc.

## SECTION VI

### THE ANEROID BAROMETER

The aneroid barometer is a cheap and handy instrument which, when carried from one point to another, will tell approximately their difference in height. This it does by measuring the pressure of the air, varying as that does when one goes up or down hill.

The essential parts of an aneroid barometer are out of sight. The instrument consists of a vacuum box with one very flexible and sensitive side, which works in and out with varying pressure of the air. This slight movement is multiplied, and converted into the circular motion of the pointing hand seen on the face of the instrument. At sea level the hand points to one part of the dial. As the instru-

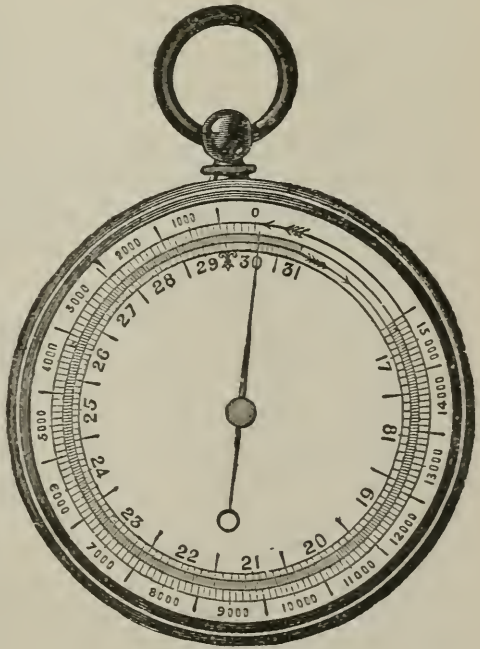

ANEROID BAROMETER

ment is carried up a hill or mountain the hand, worked by expansion of the box within, turns round to the left. The

face is graduated to correspond with the height of column of a mercurial barometer, 30, 29, 28, etc., inches, these even inches being divided into fractional parts.

This change in pressure corresponds with definite change in altitude. One inch on the scale means roughly 900 feet in altitude; a half inch means 450 feet, and so on. As a matter of fact, there is a **foot scale** on most aneroids outside the inch scale, movable and graduated from zero up to the capacity of the instrument. Thus, if one knows how high he is above sea level, he may turn the foot scale of his instrument until the registering hand points to that height, and, going either up or down hill, read directly the elevation of any station which he may occupy.

Just this process answers many purposes, but when best results are sought for, the operation is not quite so simple. First, there is the **Correction for the Temperature of the Air**. An inch difference in pressure at a temperature of  $32^{\circ}$ , for instance, converted into height, means one thing; at  $70^{\circ}$  it means a good deal more. In order to get accurate results, therefore, on considerable elevations, it is necessary to read the inner or inch scale of the instrument, take the temperature of the air at the two points, and obtain the elevation from tables. Such tables will be found on pages 111 and 112 and full directions for their use accompany them.

**Correction for Weather Change.** The other liability to error arises from the fact that the air pressure is frequently changing with the weather. This does not hamper work seriously in the western country where the weather and pressure remain steady for long periods at a time, but difficulty does arise from this source throughout the East. With an approaching storm the air grows lighter, and the reverse in clearing weather. This effect is best seen on a stationary barometer, but it has a like effect on one that is in motion. Thus, if an explorer starts at a lake of known elevation and takes two hours in going to the top of a hill, the air pressure meanwhile may have changed so as to throw his height readings off materially.

There are three ways of obviating this, outside the evident one of working only in steady weather. One is to

return to the lake and take a second reading, using the average of the two to compare with that observed at the summit. A second, often available in cruising timber, is to read on the same point two or more times during the day and so ascertain the course of the barometer. The third method of correction is by means of another instrument which is left at the base station or some other convenient point, and read by another person every hour or half hour while the observer is in the field. Since in ordinary weather the air changes are the same over large areas, this arrangement tells what the field barometer would have read on the base station at any hour during the day. Better than this, however, is a self-recording barometer, or **barograph**, which makes a continuous record of pressure. The explorer compares his pocket instru-

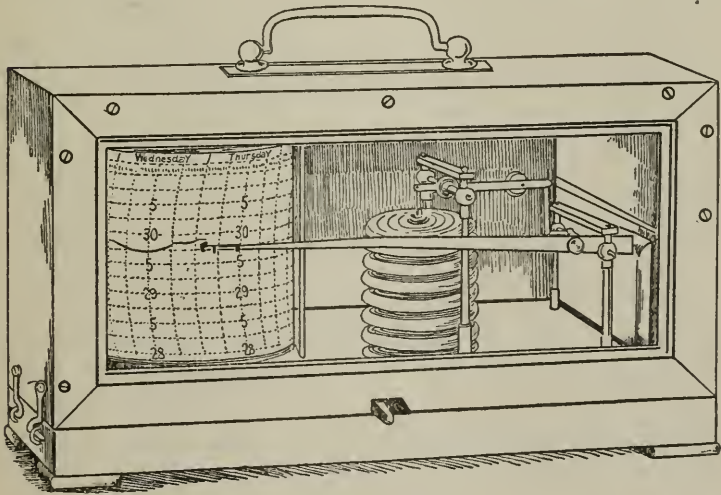

BAROGRAPH

ment with this as he starts out on his work, and again when he comes in. If these comparisons are satisfactory, he has the means of telling what his field instrument would have read on the base station at any time while he was gone, and so obtains the correct figure for comparison with any given field observation. This arrangement enables him to stay away from known elevations half a day

or a day at a time and still make fairly satisfactory height determinations.

This is all good in theory, but it must be said that in practice it does not always work out to one's entire satisfaction. The air, in the first place, is not the homogeneous fluid that it has been considered, but varies more or less from point to point. Then aneroids are not sure in their workings. Different instruments of the same make and cost vary greatly in reliability, and the observer needs to watch the best of them to see that they do not get out of order or play some kind of a trick. Barographs, again, are not thoroughly reliable. In particular, some of them do not follow the changes in pressure as fast as the portable instrument. Nevertheless, trial has shown that by the methods outlined sufficiently accurate results for many purposes can be obtained. In general it may be said of aneroid work that, while it cannot be counted on for refined accuracy, there is a large field open to it of good, useful work which no other instrument, on account of considerations of cost, can do. It is particularly serviceable in a timbered country where it is difficult to see from point to point, having there the same sort of advantage that the compass possesses in the same field.

Aneroids for ordinary work should be  $2\frac{1}{2}$  to 3 inches in diameter, graduated to the equivalent of 20 feet, and have as open a scale as may be. Such instruments cost from \$20 to \$35. For the finer class of work it may be advisable to employ a larger and more delicate instrument furnished with a vernier. A barograph costs from \$40 to \$50. Thermometers suitable for the work, in a nickel or rubber case about the size of a lead pencil, can be had for \$.50 to \$1 each.

The following **Working Rules** have grown out of the experience of the writer and others:

1. Each instrument should be tested not only under the air pump but for general behavior in the field.
2. The best place to carry an aneroid while at woods work is in a leather case hung on the belt. The case serves to protect it from damage, also from extreme heat and rapid changes of temperature.

3. Any considerable blow is likely to throw the instrument out of order for the time being, if not permanently. Two instruments carried are a considerable insurance.

4. The aneroid should always be held in the same position when read, and be given a little time to adjust itself. By gentle tapping on the face the observer should assure himself that its various parts are all free and in working order.

5. In starting out for work it is well to carry the instrument a while, so as to get it into its regular field working order, before reading on the base station.

6. One should check on points of known elevation as often as possible, and, if there is a choice of readings to refer to, he should depend on that which is nearer, time and elevation both considered.

7. A general caution may be needed that the proper use of the instrument is to obtain relative elevation of points by means of readings on the two. One must not expect by one reading to obtain his height above sea level.

#### REDUCTION OF ANEROID READINGS BY USE OF THE TABLES AND WITH CORRECTION FOR TEMPERATURE AND WEATHER CHANGES

(See tables on pages 111 and 112)

**PROBLEM I.** — *Given barometric readings on two stations and temperature at each, to find the difference in elevation of the two points.*

*Rule.* — Enter the first column of Table I with the readings of the barometer on the two stations, and take out the corresponding numbers from column 2 (column 3 is for help in interpolating). Take the difference between these two figures. Call this result for the present  $a$ .

Add the two temperatures together (or if the temperatures of the two stations do not differ materially, multiply that of the region by two). With this enter Table II, that for temperature correction, and find in column 1 the nearest number of degrees given. Take out of column 2 the number corresponding, noting the + or - sign, and

multiply  $a$  above by this percentage. Let us call this  $b$ . If  $b$  has a plus sign, add it to  $a$ ; if a minus sign, subtract from  $a$ . The result will be the desired elevation.

*Example.* — The barometric reading on a lake of known elevation is 29.500 inches, and the temperature there 72° F. Shortly after, the reading on a hill not far away is found to be 28.760 and the temperature 63°. How high is the hilltop above the lake?

From Table I we have

Barometric elevation of hill	1150 feet
Barometric elevation of lake	458 feet
Difference ( $a$ above)	692 feet

From Table II we have for  $t + t' = 135^\circ$ ,  $C = +.042$ .  $b$  therefore  $= 692 \times .042$ , is  $= 29$  feet. This must be added to  $a$ , since the sign of the factor is  $+$ , and the result ( $692 + 29 = 721$ ) gives 721 feet as the required answer.

A short cut to the same result, which is accurate enough and which will save much labor in reducing a number of readings referred to the same base station, is as follows: Between 29.500 and 28.760 inches the difference of elevation corresponding to .1 inch pressure is 94 feet. This is obtained instantly by inspection of column 3 of Table I. Stated another way, the difference of elevation in feet is 6 per cent less than the difference between barometric readings expressed in thousandths of an inch. But the temperature correction for the conditions is  $+4$  per cent, leaving a net loss of 2 per cent on the difference in the barometric readings.

Now  $29.500 - 28.760 = .740$ , and  $740 - 2$  per cent  $= 725$ . Answer, 725 feet.

*PROBLEM II.* — *To correct for changes of pressure due to the weather, as shown by regular readings on a station barometer or the record of a barograph.*

The barograph sheet reproduced herewith shows for the working hours of that Friday a steady fall of pressure. At 6.30 in the morning when the party left camp the indicated pressure was 29.250 inches. When they got in

at 5 P. M. it was 29.100. That difference in pressure corresponds to nearly 150 feet in elevation, and height observations made during the day would be uncertain to very wide limits if the change could not be allowed for.

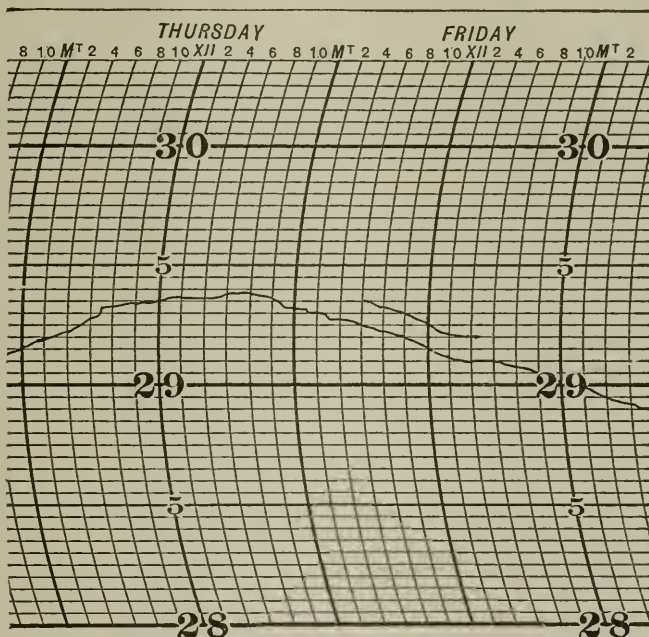

The possibility of correction rests in two suppositions: (1) that at any moment of time the air pressure is constant over a considerable horizontal area, and (2) that the field barometer and the station barometer work together, and that they both follow exactly and quickly the change of air pressure. The latter point may be expressed in this way — that the field barometer, if left at the base station, would have followed the same course as did the instrument which in fact was left there.

The field barometer may not read the same as the barograph when they are brought together, but that "index error," as it is called, does not matter if the difference between the two remains constant. In this case the field barometer at camp in the morning read 29.350 and at night 29.200, .1 inch higher than the barograph. One may, therefore, when he gets to computing, draw on the

barograph sheet a curve through these two new points and parallel to the one made by the barograph pen. From this curve he may take off the reading for any hour in the day to compare with a field reading taken at the same time. Such a supplementing curve is shown on the sheet illustrated.

*Example.* — At 11 A. M. on the day in question at a point two miles away from camp the field barometer read 29.270. What was the elevation relative to the base station?

The field reading can not be compared with the morning reading at camp because the barometric pressure is known to have been changing. Neither can it be compared with the night reading, for the same reason. The short curve on the sheet, however, does tell what the field instrument would presumably have read at camp at any hour in the day. The curve at 11 A. M. is at 29.270, and the two points, therefore, are of equal elevation.

In view of the low accuracy of aneroid work, different users of the instrument have devised schemes for shortening or obviating the labor of computation. One that is serviceable where temperature at different seasons shows wide variation is as follows:

On the foot scale of most instruments 1000 feet at the higher elevations will be found to occupy a smaller sector on the scale than 1000 feet at low elevations — as 5000–6000 as against 0–1000. This can be tested by comparing against identical marks on the inner scale.

Now, being at a known or assumed elevation, set the corresponding graduation against the movable hand and observe where the thousand-foot marks above and below cut the inner or inch scale; next, take the values so obtained and compute difference of elevation accurately, correcting for temperature. If the result obtained varies seriously from 1000 feet, shift the foot scale by even thousands until a portion is found so graduated that it does correspond. With a constant correction of even thousands, elevations may now be had directly. Correction is not thus made for weather changes, however.

TABLES FOR REDUCING READINGS OF THE ANEROID BAROMETER<sup>1</sup>

## I — Barometric Elevation

Reading Inches	Elevation Feet	Difference for .01 inch Feet	Reading Inches	Elevation Feet	Difference for .01 inch Feet
20.0	11047		23.4	6770	-11.7
20.1	10911	-13.6	23.5	6654	-11.6
20.2	10776	-13.5	23.6	6538	-11.6
20.3	10642	-13.4	23.7	6423	-11.5
20.4	10508	-13.4	23.8	6308	-11.5
20.5	10375	-13.3	23.9	6194	-11.4
20.6	10242	-13.3	24.0	6080	-11.4
20.7	10110	-13.2	24.1	5967	-11.3
20.8	9979	-13.1	24.2	5854	-11.3
20.9	9848	-13.1	24.3	5741	-11.3
21.0	9718	-13.0	24.4	5629	-11.2
21.1	9589	-12.9	24.5	5518	-11.1
21.2	9460	-12.9	24.6	5407	-11.1
21.3	9332	-12.8	24.7	5296	-11.1
21.4	9204	-12.8	24.8	5186	-11.0
21.5	9077	-12.7	24.9	5077	-10.9
21.6	8951	-12.6	25.0	4968	-10.9
21.7	8825	-12.6	25.1	4859	-10.9
21.8	8700	-12.5	25.2	4751	-10.8
21.9	8575	-12.5	25.3	4643	-10.8
22.0	8451	-12.4	25.4	4535	-10.7
22.1	8327	-12.4	25.5	4428	-10.7
22.2	8204	-12.3	25.6	4321	-10.6
22.3	8082	-12.3	25.7	4215	-10.6
22.4	7960	-12.2	25.8	4109	-10.5
22.5	7838	-12.2	25.9	4004	-10.5
22.6	7717	-12.1	26.0	3899	-10.5
22.7	7597	-12.0	26.1	3794	-10.4
22.8	7477	-12.0	26.2	3690	-10.4
22.9	7358	-11.9	26.3	3586	-10.3
23.0	7239	-11.9	26.4	3483	-10.3
23.1	7121	-11.8	26.5	3380	-10.3
23.2	7004	-11.7	26.6	3277	-10.2
23.3	6887	-11.7	26.7	3175	-10.2

<sup>1</sup> Taken from Johnson's "Surveying" and Report of U. S. Coast and Geodetic Survey for 1881.

I—Barometer Elevation—*continued.*

Reading Inches	Elevation Feet	Difference for .01 inch Feet	Reading Inches	Elevation Feet	Difference for .01 inch Feet
26.8	3073	-10.1	28.7	1207	-9.5
26.9	2972	-10.1	28.8	1112	-9.4
27.0	2871	-10.1	28.9	1018	-9.4
27.1	2770	-10.0	29.0	924	-9.4
27.2	2670	-10.0	29.1	830	-9.4
27.3	2570	-10.0	29.2	736	-9.3
27.4	2470	-9.9	29.3	643	-9.3
27.5	2371	-9.9	29.4	550	-9.2
27.6	2272	-9.9	29.5	458	-9.2
27.7	2173	-9.8	29.6	366	-9.2
27.8	2075	-9.8	29.7	274	-9.2
27.9	1977	-9.7	29.8	182	-9.1
28.0	1880	-9.7	29.9	91	-9.1
28.1	1783	-9.7	30.0	00	-9.1
28.2	1686	-9.7	30.1	-91	-9.0
28.3	1589	-9.6	30.2	181	-9.0
28.4	1493	-9.6	30.3	271	-9.0
28.5	1397	-9.5	30.4	361	-9.0
28.6	1302	-9.5	30.5	-451	-9.0

## II—Correction for Temperature in Degrees Fahrenheit

t + t'	C.	t + t'	C.	t + t'	C.
0°	-0.1025	60	-0.0380	120	+0.0262
5°	-0.0970	65	-0.0326	125	+0.0315
10°	-0.0915	70	-0.0273	130	+0.0368
15°	-0.0860	75	-0.0220	135	+0.0420
20°	-0.0806	80	-0.0166	140	+0.0472
25°	-0.0752	85	-0.0112	145	+0.0524
30°	-0.0698	90	-0.0058	150	+0.0575
35°	-0.0645	95	-0.0004	155	+0.0626
40°	-0.0592	100	+0.0049	160	+0.0677
45°	-0.0539	105	+0.0102	165	+0.0728
50°	-0.0486	110	+0.0156	170	+0.0779
55°	-0.0433	115	+0.0209	175	+0.0829
60°	-0.0380	120	+0.0262	180	+0.0879

## SECTION VII

## METHODS OF MAP MAKING

## 1. INTRODUCTORY

There is a well defined call at the present time for good maps of small forest areas — maps which show topographic features and record essential facts about timber stand. With the consolidation of large forest properties and their more careful and foresighted management, the need is felt for good maps of these as well, and it is certain that this demand will increase.

The maps of the past are of all grades of accuracy and utility. A checkerboard of lot lines, with the waters roughly laid down, and estimates of the stand of timber, is the utmost that many lumber companies can command. Some improve this by hatching to represent mountains and divides, and by going more carefully into water lines and areas.

**Hatched Maps.** The accompanying map represents part of a township owned by a Maine lumber company, and is a good example of a class of maps now having wide use. For the purposes of the map and of administration, the township was divided into sections, and as the lines were run, chainage was taken at the crossings of streams and main divides. In addition, some cruising was done within the lots, chiefly to ascertain the amount of timber. On this basis the map was drawn. The course of streams is shown approximately. Mountains and prominent ridges are hatched in. Main existing roads may be put in roughly.

A map like this, with lines on the ground to correspond with it, is of great service in the management of forest property. Logging contracts can be let with clearly defined boundaries; distance to haul is approximately known; in a rough way the nature of the ground is represented. It has, however, very evident limitations. Off the section lines, it is all judgment or guesswork, and the details of the country, such as have a very material effect

on all operations, are not shown and cannot be shown with that method of representation.

The cost of such a map is very slight over and above the cost of the survey work in sectioning. That in the region named commonly costs from \$600 to \$800 per township. If a region is divided into sections or quarter-sections, a

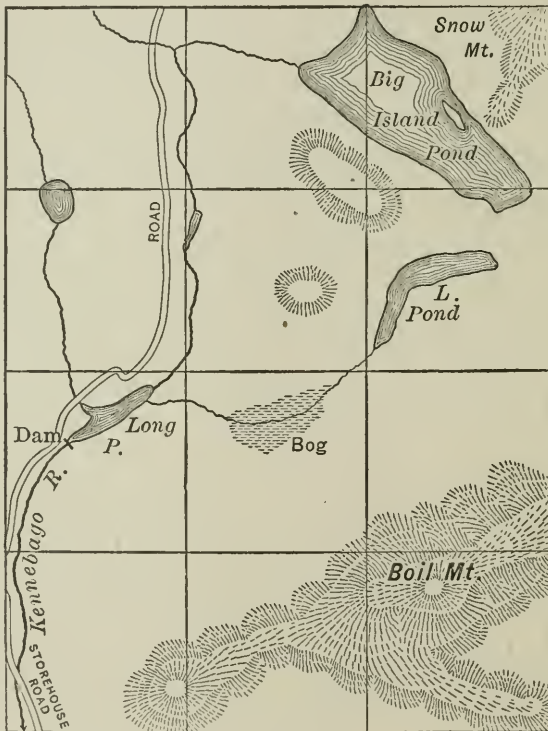

good cruiser can produce a map like this as fast as he can travel over the country.

**Contour Maps.** The actual shape of a country is best represented by contour lines. A contour line is a line of equal elevation, the line a man would follow if he traveled round a country keeping at a constant height, or what would be the shore line could a country be submerged to a given level. The base level of a map representing a country near the seashore would naturally be sea level. The first contour on the map might follow the line of 100

feet elevation, the second run 100 feet above that, and so on, one for each 100 feet. A little consideration will show that the lines indicate not only direction of the slope of the land, but also the rapidity of slope, for when contours are close together the ground is steep, while on flat land they are wide apart. Hill tops are circled by a succession of contour lines. On lower land they often run in a very sinuous course.

When one examines such a map and thinks of its construction, the first idea is that a tremendous amount of labor is involved. To follow out a succession of contour lines with ordinary surveying methods would indeed be an endless task. That is not the method of construction, however. It is rather sketching, guided by the location, in horizontal position and height, of a sufficient number of points. If one knows how high the top of a hill is above its base, that tells one at once how many contours, 100 feet apart, come between the two, and a glance at the hill perhaps will tell if it is of even slope. Similarly the location of divides and ridge tops, and, on the other hand, of low points, whether occupied by water or not, gives control points which aid in representing the slope of the land. The main problem of the topographer is how best to make these locations — most accurately and at least cost.

**General Considerations.** The instruments and methods available for the production of topographic maps have been described on previous pages. In employing them, to secure practical results, very much depends, of course, on their effective use and proper combination. In this relation, some general principles of surveying work and the conditions of woods work, as distinct from those of ordinary surveying, require first to be stated.

1. A hunger for accuracy is part of the make-up of every good surveyor and map-maker. At the same time, he has to remember that if such work costs more than it is worth to the man who pays for it, it will not be done. Accuracy to a certain degree is necessary; on the other hand, there are limits of cost. A proper balance between the two is required. The result may be called an *efficient* map.

2. In securing an efficient map, a main principle to hold in mind is the relation between accurate and expensive work and work of a lower degree of accuracy. If elevations in a topographic survey were put in by level only, and horizontal positions fixed by compass and chain, an accurate result would be had, it is true, but it would be at enormous cost. On the other hand, the use of barometer and pacing alone might furnish a map so inaccurate as to be of little account. The effort must be to construct a skeleton of reliable points and lines, to which less accurate and costly work may be tied — to put points within reach, one might say, of the weaker method or instrument. Surveyor's compass and chain, staff compass and pacing, and sketching form such a series in the horizontal determination of points. The level, the aneroid, and sketching are similarly related in height work. Sketching is the final term in any case, and much depends on it for both accuracy and appearance. In a way, it is easy, but real excellence in the art depends on a combination of eye, memory, and artistic sense.

3. Throughout any ordinary work of this kind, it has to be understood that much detail is too fine for representation or is really unessential, and on that account the topographer should neglect it. Makers of accurate maps neglect only what does not show on the scale of the map. Woodsmen will generally find it necessary to adopt a more liberal rule.

The conditions under which forest mapping is done have an influence on methods in the following ways.

1. Timber growth itself presents an obstacle to clear sighting. That favors the compass as against the transit for boundary work, and in the same way, in topographic mapping, triangulation and the vertical angle are put at a disadvantage as against methods which can be carried on under the cover of the woods.

2. Forest topography should generally be tied to property boundaries, rather than to topographic prominences. Commonly, a survey of his boundaries is the first and most important work to be done for an owner who wants accurate knowledge about his land. It will, there-

fore, save time and money if the interior features can be tied to them.

3. Topographic maps of forest property should be especially clear in respect to road lines and other points of importance in lumbering operations. The map-maker should, therefore, understand these operations. It will, also, save time and money if topography and timber can be examined together, at the same time, and by the same man.

With these principles in view, the following are methods recommended for the production of forest maps. It is well in discussion of the matter to divide the work into two classes — that on small tracts, where close work is required, and that on larger tracts, where different methods must be employed and a lower standard of accuracy may be allowed.

## 2. MAPPING SMALL TRACTS

A tract of eighty-nine acres, well timbered and of strong relief, that was surveyed by the class of 1907 in the Harvard School of Forestry will serve as illustration. The following steps were taken in the process.

1. Boundaries surveyed by compass and chain; marked stakes left every twenty rods; bounding lines and corners remarked. Two days' work for three men, more if there is special difficulty with the old boundaries.

2. Elevation of one convenient point ascertained or assumed, and levels run over the roads crossing the tract, leaving bench marks plainly marked every twenty rods or so. Levels, also, run down to point *x*. (See page 119.) One half day's work for two men.

3. Outlines of tract plotted to scale on paper; this pinned on traverse board with meridian of survey parallel to N and S edge of board; roads run in with the chain and position of bench marks taken. One half day's work for three men.

4. Sheet on the board without the tripod taken into the field, a scale serving for alidade; detail mapped in by short foot traverses from the known points; elevations got partly by aneroid, partly by hand level. One day's work

for one man. Any board to hold the sheet will do, a small compass being used to orient it. By the time this work is done, a practical man may, in addition, have learned about all he wants to know regarding the timber.

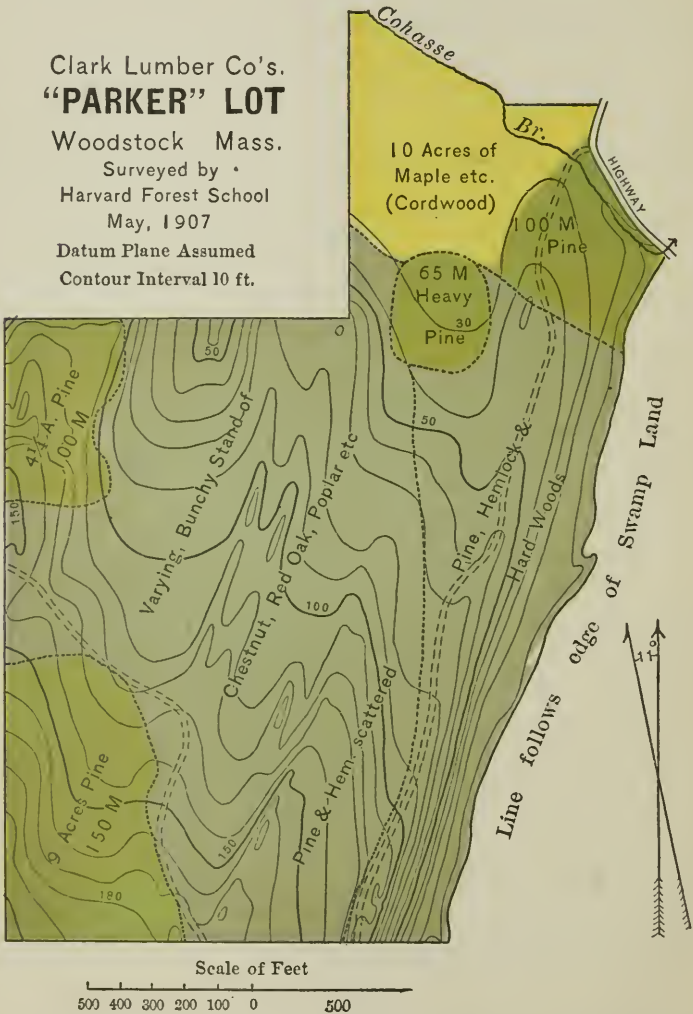

5. Since the lot is to be operated from a portable mill set near its northeast corner, go over the lot with the map in hand and see that the topographic difficulties and opportunities are correctly represented.

**Alternative Methods.** 1. Compass and chain may be used to survey the roads and the plotting done off the field. This is most convenient in wet weather, but when a traverse board is at hand and can be used, it will be found the quickest method of survey and the least liable to error.

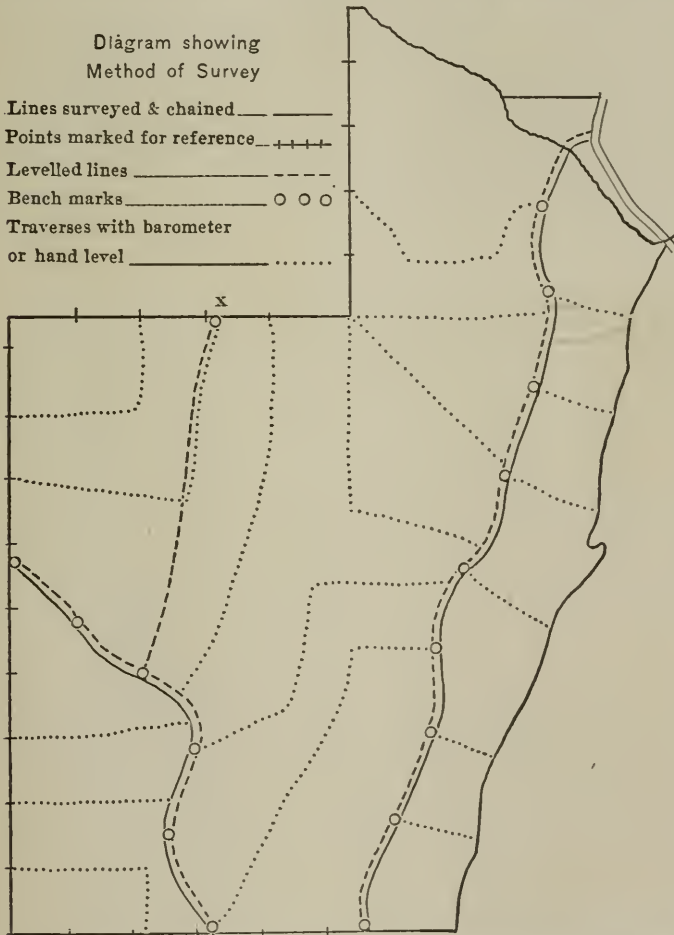

2. Transit and stadia might be substituted for both level and traverse board in the survey of the roads, and, where the woods are open enough, in mapping the detail of the topography. This method involves much computing, is generally cumbersome, and except in the hands of a skilled and practiced man is liable to give rise to error.

3. After the boundaries are surveyed and the primary point in elevation is fixed, a topographic survey and timber estimate might be made together by means of the strip system of survey described on page 188. For the topographic work, a barometer would be carried in the party

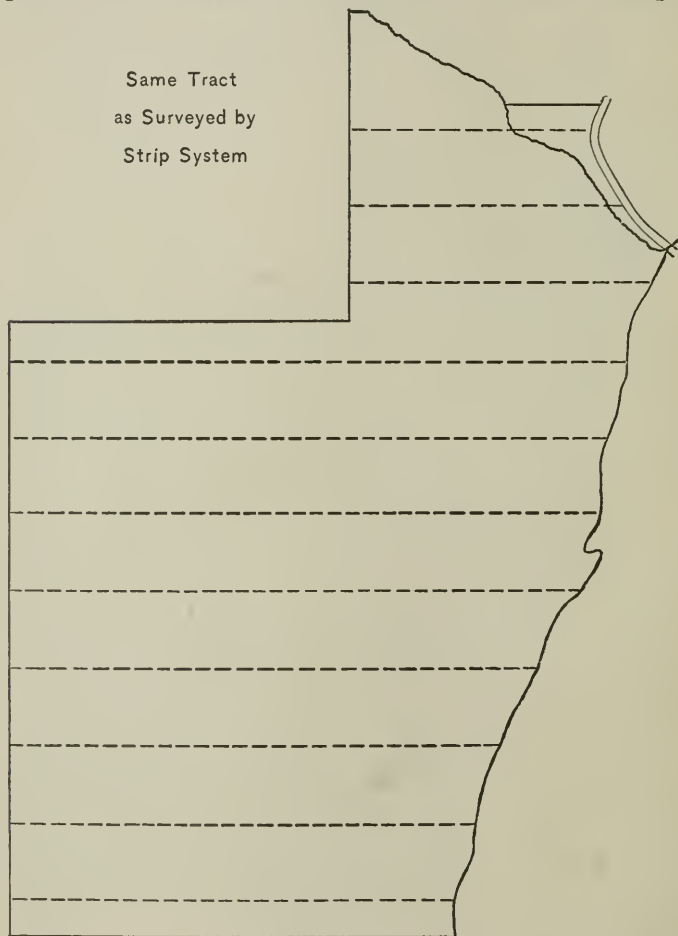

and the elevation of needed points read and noted or plotted down in connection with the chainage by the note-keeper. If the air pressure was not steady, it would be necessary for the barometer man once in a while to leave the party and go back to the base for correction. The combination of barometer and barograph gives rise, in a

method already not too accurate, to additional errors, and should not be employed except when it is the only practicable method.

This method of survey may suffice in favorable conditions, and where the requirements are not of the strictest. Work with the level, however, is quick and sure, and in general it will be found advisable to use it freely.

**The Map.** In plotting tracts of this size, and up to a few hundred acres in extent, scales of 400 feet or 20 rods to the inch are found to go well with a 10-foot contour interval, and to furnish a serviceable map. A larger scale and a smaller contour interval would naturally go together.

### 3. MAPPING LARGE TRACTS

**A. With Land already Subdivided.** If the region to be mapped comes under the public land surveys, or if there are plain and reliable lines of other origin on the ground, a skeleton of level lines with barometer work tied to them is the treatment indicated. Generally the level work is best carried along the waters or roads. Ponds and lakes form the best sort of reference points, and frequently natural water levels perform a large part of the work required. Section lines may, however, furnish in some cases the best routes available, while on very broken land it might be necessary to resort to the vertical angle.

How the barometer work shall be done depends on circumstances. If the weather is perfectly steady, or the level points are near enough together, elevations may be read direct without a weather change correction. If, however, the weather is shifting, and the cruiser must stay away from known points many hours at a time, a station barometer or barograph will have to be employed. In any case, the topography can be mapped at the same time that the timber is being examined.

**B. Topography Based on Survey of Roads or Streams.** If the tract to be surveyed is an undivided township, or is in any other form that is too large for accurate mapping, it may be cut up by one means or another into smaller areas that can be handled. The lines of easy subdivision naturally

furnished by a large timber tract are its streams. On these transit and stadia furnish the most efficient means of survey. If roads are available, the same method may be employed, or another may be substituted.

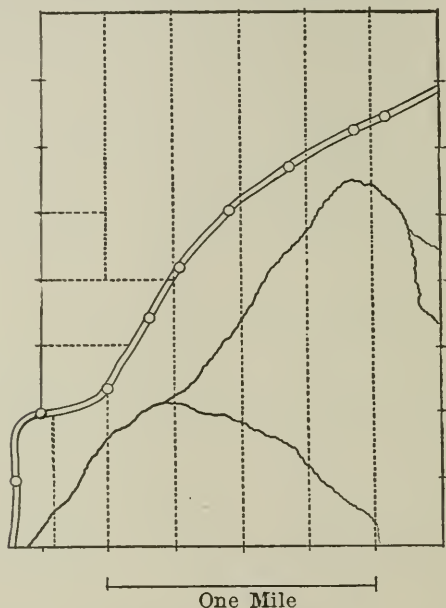

Surveyed bounds with chainage marks ——— + ——— +

Road surveyed by stadia, reference points  
fixed by stadia and by level ——— ○ ——— ○

Strip surveys with barometer ——— ······

On the tract used in illustration, the road, rather than the stream, was used for the subdivision. The different steps in the process of survey were as follows:

1. Outside boundaries run with compass and chain. Chainage marks for reference left every quarter mile.
2. Road across the tract surveyed by transit and stadia, using the needle and setting up the instrument at alternate stations. Points marked at short intervals. See notes on page 86.
3. Level line run along road, giving elevation of points established in the stadia traverse.
4. Strip surveys run between the road and the boundary

(see page 188), tying into the marks left. Elevations got by aneroid, corrected by barograph. Numerous modifications of the rectangular system made as required.

**Alternative Methods.** 1. On roads the traverse board with chain is undoubtedly the best instrument for making a survey of fair accuracy. The compass and chain might also be used. But when streams are utilized, unless on ice, stadia measurement will be found to be best and quickest.

2. The level might be dispensed with, and the transit used as a level on the same settings from which it is used to get bearing and distance. This works best on a stream with grade all one way, and, in the case of a party by itself in the backwoods, is probably the best means of getting data of this kind. One additional man is then required for maintenance.

3. Instead of the strip survey, using compass and chain, compass and pacing may be employed with circular plots for the timber. It may also be better or necessary to discard both rectangular systems, and work out the topography by means of road lines, passes, etc., controlling features in the lumbering development.

**C. Subdivision and Topographic Survey Combined.** The following procedure has been carried out on a considerable scale on undivided townships in New England. The methods employed have been found to be cheap and practical, and the maps resulting have stood the tests of use and time.

1. Boundaries renewed and tract divided into sections by compass and chain. Topographic notes taken; chain-age marks left every quarter mile. Two months' work for a party of seven men.

2. Elevation of some point above sea level obtained, if possible; if not, datum plane assumed at or below lowest point on the tract. Level lines run over roads and streams to ponds, camps, and other accessible points, well distributed through the tract. Commonly a week's work for two men.

3. Detail of topography and timber worked out together. Mountain peaks located by cross bearings; streams and roads by compass and pacing traverse; other features

partly by traverse, partly by straight-line travel across the sections. Elevations by barometer checked by the barograph whenever it is necessary to remain away from known points a considerable time. Timber estimated and topographic notes obtained at same time. Cruising, reduction of notes, and map making about six weeks' work for the explorer, who may need a companion or camp man.

**Comments.** 1. Division into mile squares may look expensive, like going a long way round to secure topographic data. These lines, however, have value on other accounts; have, in fact, proved their value over and over again in timber land administration. As before stated, they are useful in definitely bounding logging contracts, they are perfectly understood by logging foremen, and are of great service to them in their timber estimates and the laying out of their roads. They are, in addition, of great service in keeping track of subsequent cutting or other developments on the land.

On the other hand, the mile square is not so large an area but that it can be mapped accurately and its timber estimated according to the methods here recommended.

2. The strip survey system might, of course, be used instead of the one-man system employed. The advantages of each will be understood from what comes before and after.

3. It may be advisable in some cases to separate entirely the topographic and timber work. In general, however, the thoroughly equipped man will find that travel that helps him in one direction helps also in the other.

**The Maps.** Maps of forest property should be on a large scale to allow the preservation of notes about small bunches of timber, etc. Four inches to the mile for tracts of large size has proved serviceable. As to contours, a fifty-foot interval will serve, in the rough land of New England, to represent most features of the topography.

The results of such a survey are, for business purposes, best embodied in two map sheets, one showing the waters, relief, and other permanent features of the country, the other exhibiting all the facts concerning the timber. This last should be on tracing linen, so that it may be laid

over the topographic sheet, and the two seen in relation. Not only the amount of timber is thus exhibited, but the steepness of the ground it stands on, and the distance it must be hauled. It will appear, too, whether a valley has been cut clean to a divide. On this *timber sheet*, cuttings and other operations of succeeding years may be plotted. If it gets too complicated, it may be thrown away and a new one substituted.

A sample map of this kind is reproduced on reduced scale herewith. These maps may also be supplemented by topographic models. Contour maps are not read easily by every person, as, for instance, by some lumbermen, but a model of the land, as it lies out of doors, is immediately grasped by all. With the aid of a blue print of the map which may be cut up and used as a pattern a model is cheaply built out of cardboard or veneer. With such a model at hand, a contract may be let or plans of work talked over in the office with the same clearness as to major features as if men stood on the ground.

Following is a topographic map of a section of land as derived from traverse of the boundaries, a road, and two trips across it. After that come notes of the road traverse and of one of the trips across it. For notes of survey of south line see page 29. On the map observed elevations are written in. Contours as seen are solid; contours inferred are broken.

**Principles of Cruising.** A plan of cruising designed to secure topographical and timber data every man will think out for himself and a new one for each tract undertaken. The following, however, are believed to be sound principles for guidance in this class of work.

1. Main streams, roads, lakes, etc., should of course be traversed, and they may be important enough to demand some other method of survey than compass and pacing. One should be very careful, too, about waste lands, burns, and the boundaries of heavy bodies of timber.

2. It is generally advisable to explore the country one section at a time, for in that way one comes out with the clearest ideas upon it.

3. Cross country travel which locates brooks and ridge

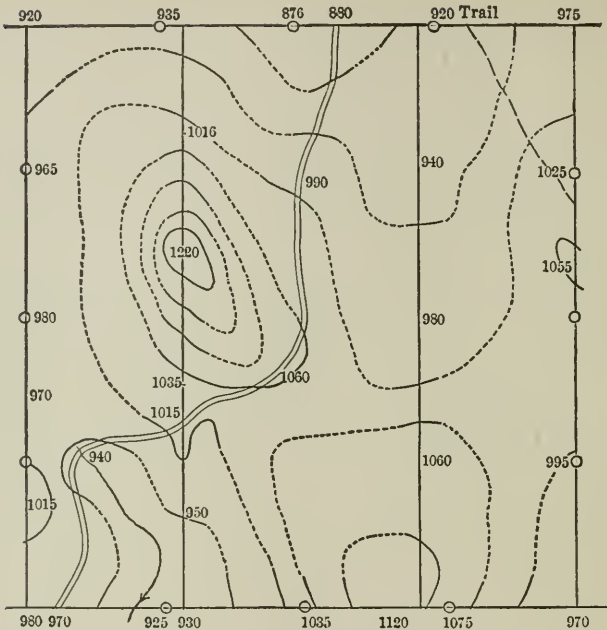

tops by intersection may suffice for topographical purposes, while it gives a juster view of the timber than could otherwise be gained. Locations, too, will be more accurate along such a line than where a crooked route is followed.

4. Extreme points are in general the ones to read on for height, — that is to say, ridge tops, brook crossings, etc. One may combine with this also a system of reading at regular intervals. It will be enough to read the thermometer half a dozen times during a day to get the course of the temperature, unless extremely high points are occupied.

5. Relative heights are frequently of far more importance for logging purposes, as, for instance, in connection with the grade of roads, than is absolute elevation. It is often advisable, therefore, to establish sub-centers of work and determine elevations relatively around them rather than refer readings always to a distant base station. On the same principle, if a region is hard to get at with the level, it may serve the purpose of the map to fix the height of some central point in it by two or more aneroid readings, and then work around that.

Starting at South line of Township, 25 rods E on the S line of Section as given in survey notes. Elevation 970 ft. as ascertained from pond nearby determined by level.		
Thence in section 25		
Bearing	Paces	
N20°E	200	} Along easy slope right, in good timber, to swamp
N5°E	350	
N50°E	75	to small brook running SE. Elevation 940'
N82°E	250	at 100' into timber again
N73°E	150	} up slope, to pass between hills right & left Elev. 1060'
N65°E	325	
N42°E	175	} on a general slope East of about 10% to flat land and
N25°E	400	
N20°E	225	Elevation 990'.
N	300	} In flat land with thick spruce growth to North line section 25. 190 rods East on it as given by Survey notes.
N8°W	225	
		Elev. 880 ft. Checked on B.M. half an hour later

COMPASS AND PACING TRAVERSE OF ROAD ACROSS SAME SECTION.  
ELEVATIONS READ FROM FOOT SCALE OF BAROMETER

6. There is occasionally a locality especially critical from the lumbering point of view, such, for instance, as a pass which makes it possible to haul from one drainage to another with a level road. The topographer ought to be enough of a lumberman to recognize these points, and when he does he will put special time and pains upon them.

7. Field observations may be recorded either in the form of running notes, or mainly in the shape of sketches on a plat of the ground. Probably a combination of the two methods will be found most satisfactory. A note book especially ruled for the purpose to the same scale as the final

	<i>Bar. Camp. (Elev. by level 901') 6 A.M.</i>	29.350		
	<i>T.A. 60° Barograph 6 A.M.</i>	29.250	<i>Bar.</i>	<i>Computed Elevation.</i>
	<i>Canada road on N. line section 25</i>	<i>Time 7.10</i>	29.360	.881'
<i>Steps</i>	<i>Go West on Section line</i>			
190	<i>½ mile mark of survey. Flat Spruce ground.</i>	29.365		876
510	<i>¾ mile mark. slope N.E. then N.</i>	29.295		935
515	<i>Section corner. Gentle slope N.W. All spruce</i>			
	<i>timber.</i>	<i>Bar. 7.40</i>	29.305	920
	<i>Return to 100 steps E. of ¾ mile mark and</i>			
	<i>go S. 7° W. in Section. Start at 7.50 A.M.</i>			
350	<i>Gentle slope N.N.W. spruce growth</i>	29.205		1016
400	<i>Top of hill, falls steeply E. and W.</i>	28.990		1220
470	<i>Down strong grade S.W. Timber on hill mixed</i>			
	<i>and short. Bottom rough</i>	29.175		1035
175	<i>Canada hay road on easy land</i>	29.195		1015
375	<i>Down easily in large mixed growth to edge</i>			
	<i>of swampy land</i>	29.260		950
280	<i>Township line 60 steps East of ¾ mile mark</i>			
	<i>Bar. 9.35 (T.A. 65°)</i>	29.280		930
	<i>Bar. Camp 11 A.M. (T.A. 69) 29.280</i>			
	<i>Barograph 11, 29.175</i>			

STRAIGHT TRAVERSE ACROSS SECTION. ELEVATIONS BY BAROMETER  
CORRECTED BY BAROGRAPH

map will be found a great saving of labor and an aid to clearness.

8. The map is best worked up on the ground. The added accuracy and certainty gained in this way more than pay for the cost of carrying necessary equipment around. The topography may be drawn in pencil on the final manuscript sheet, and an outline sketch on any kind of paper will serve to gather up the timber notes temporarily.

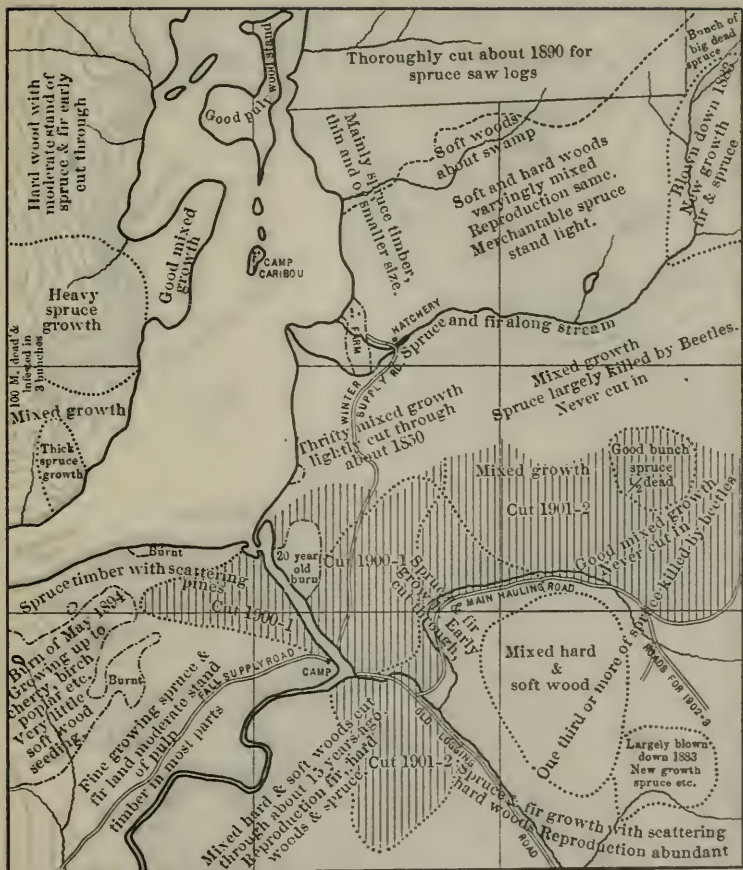

## TIMBER SHEET

Explored 1900      Cutting since that date marked by section lining

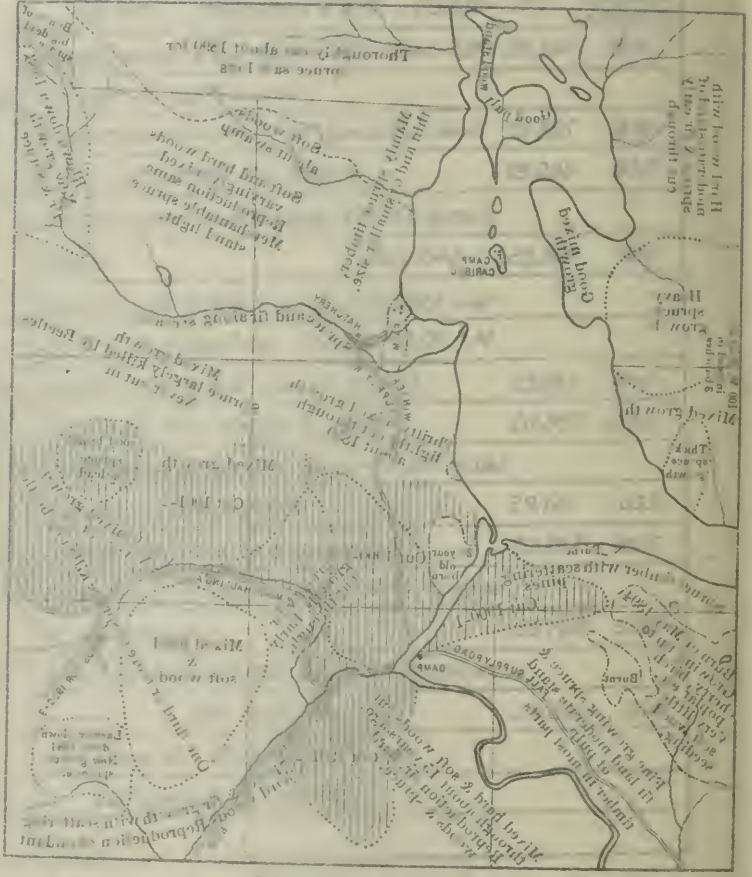

TIMBER SHEET

Explored 1900 Cutting since that date marked by section lines

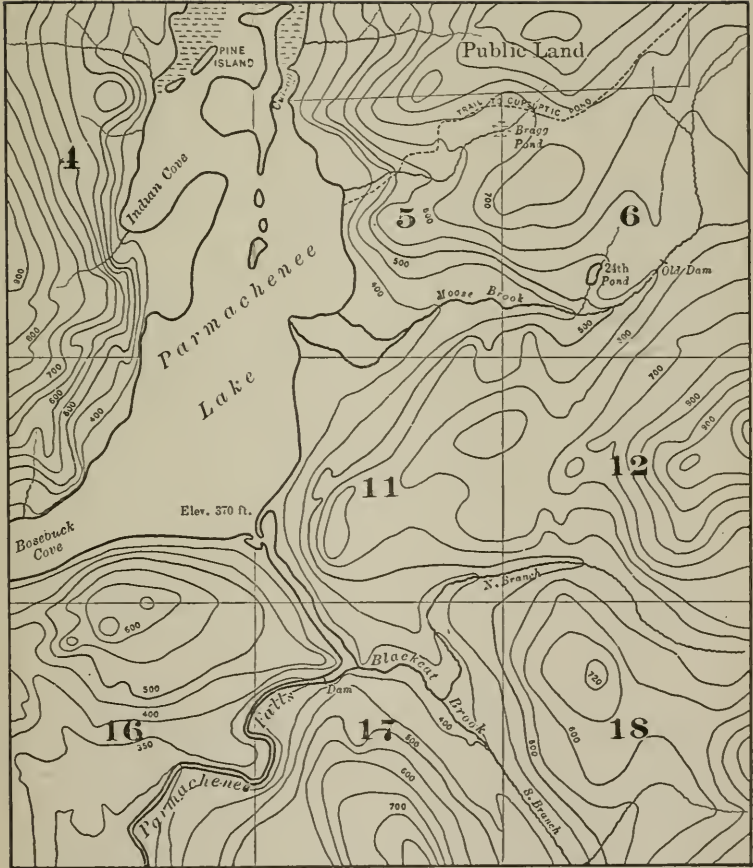

PORTION OF TOWNSHIP 5 R IV OXFORD CO. MAINE  
 Topographical Sheet      Datum Plane, Umbagog Lake  
 Contour Interval = 50 feet



#### D. Western Topography. Use of the Clinometer.

The above described methods grew up in the East among varied conditions of topography and value. Brush that interferes with sighting is widely prevalent, and another determining factor is the general employment of horse logging, a style of operation for which close regulation of grades is not essential. Conditions in the West are frequently different from the above, in respect to one or more particulars.

The aneroid barometer has not on that account yielded its place entirely. Particularly in Western Washington and Oregon does it still hold the field, because of the dense brush widely encountered, which makes almost impossible the clear sighting necessary for the employment of any other height-determining instrument. On the contrary, the temptation is to rely on the aneroid for work that it should not be called upon to do. Where, as is the case here, railroads are employed for nearly all main transportation, heights with a reliable basis are essential if a map is to be widely serviceable. Frequently the ground lies in such a way that the routes of future railroad development are evident. Levels run along these routes, with aneroid work for the rest, is then the natural treatment. Just this method has been employed in numerous cases.

Such logical and adequate treatment is not always possible, however, nor is it always permissible under the restrictions of the work in hand. A variety of methods is in fact employed, especially for the control work. As for the detail, the fact remains that when points in elevation have been reliably determined at distances not more than from one to two miles apart, good aneroids intelligently used will give topography sufficiently accurate for general purposes, while here as elsewhere their use saves expense by permitting the topographic and estimating work to be done together. Complaints of the results of aneroid work frequently arise from unskilled use and from employment of instruments of inferior character. The quality of instruments obtainable at moderate cost has within a very few years greatly improved. It is not to be

denied, however, that rapid weather changes sometimes make accurate work difficult.

Some interior mountain territory is characterized by lightly forested ridges contrasting with great density of timber and brush along the streams, while logging methods are often such that accurate knowledge of grades on valley lines is not essential. In circumstances such as these, circuits of transit and stadia work carried over the ridges have proved a satisfactory method of height control. When areas concerned have never been covered by the land surveys, angles have been turned and read in addition for the purpose of control in the horizontal direction.

With control laid out in this way the early plans of reconnaissance in such country involved, as the next step, the crossing of valleys with strip surveys, the aneroid being relied on for elevation. This plan of work, starting from known points on the ridges and running long lines independent of one another, crossing the brooks and valley bottoms (where grade was most important) at a long distance from known bases both horizontally and vertically, made demands on the aneroid which it was not able to meet successfully.

Height work along the stream lines was an evident corrective, but a substitute scheme that at the time of writing seems to be filling the requirement is the use of the tape and clinometer.<sup>1</sup> Both instruments have, however, been subjected to modification. The clinometer has been made more efficient in numerous ways; in particular the arc has been enlarged and so graduated that instead of degree or per cent of slope it gives difference of elevation in feet for the given slope and a stated distance (66 feet or one chain in present practice). The tape used for the purpose is  $2\frac{1}{2}$  chains long, two chains of it marked in links as usual, while the extra length or "trailer" is so graduated that the inclined distance along any slope which corresponds to two chains horizontal may be set directly. By these devices two short cuts are accomplished: first, difference in

<sup>1</sup> For a fuller description of this method see "The Timberman," March, 1916, or "Engineering News," Vol. 75, No. 1, p. 24.

elevation is found directly from the slope observation; second, with similar directness surface chainage is converted into horizontal distance. These two things are the essentials wanted. To facilitate the work, the graduations on the trailer of the tape correspond with those on the arc of the clinometer.

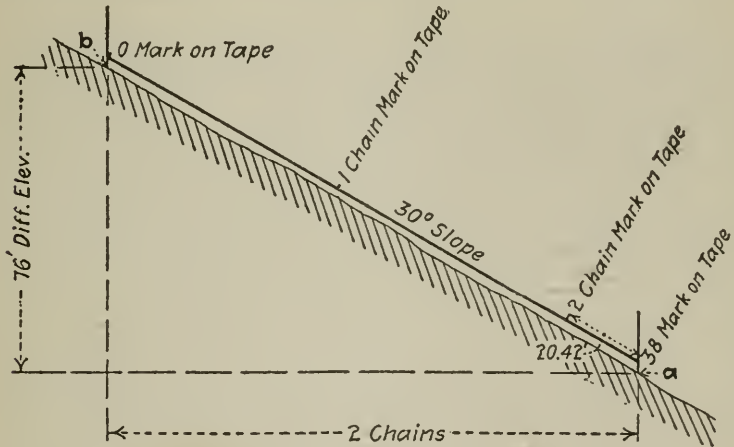

The method will be grasped from the accompanying figure and the following explanation: If a party is ascending the slope indicated in the figure, the man ahead (who serves not only as head chainman, but runs the compass, takes notes, and sketches topography), as the tape comes to its end, sights with his clinometer at the height of his eye on the rear man (who may be the timber cruiser as well as rear chainman). The reading obtained, in this case 38, is the vertical rise per 66 feet horizontal on the slope between the two men. That corresponds to a vertical angle of  $30^\circ$ , but the fact, not being needed, is neglected. The topographer now calls out "38" to the rear man, who lets the tape run out to that mark, as a matter of fact 20.42 feet beyond the two-chain point. When the chain to this mark has been drawn straight and taut and pins are set, two chains is the horizontal distance between them. This the topographer may now plot on his map. The height of the new point (twice 38, or 76 feet above the first one) may also be used as the basis of sketching.

Two miles per day are readily covered by two men, drawing topography carefully and estimating a good stand of timber. Not only has cruising work been done by this method, but control work as well, using more care and two instruments. This last use of the method requires making circuits several miles in length around either subdivisions of

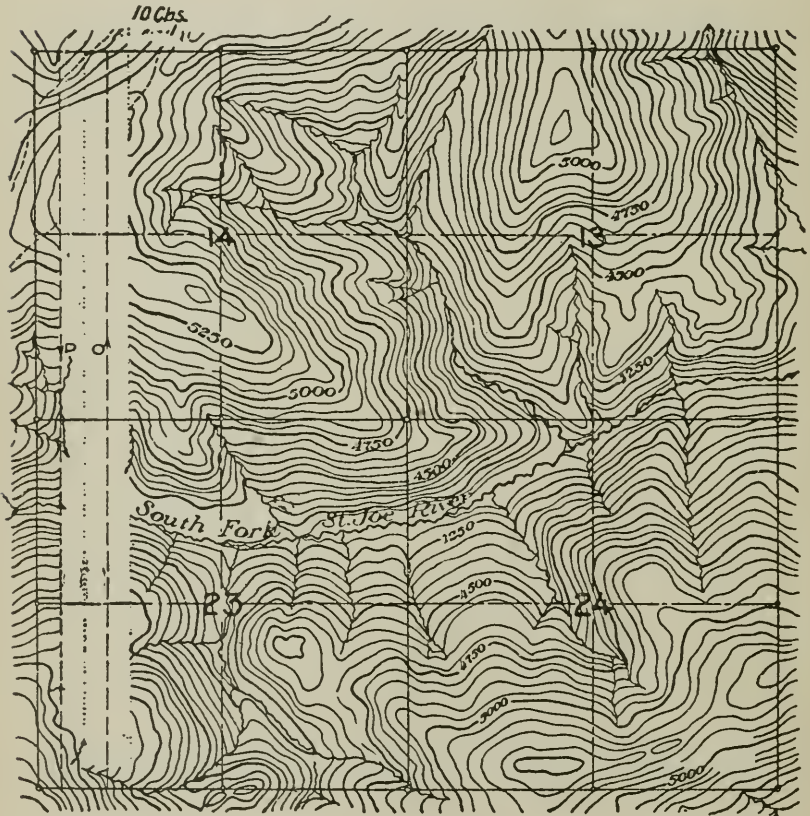

land or topographic areas. For cruising work the method is carried at farthest two miles to a tie point. Errors in direction and distance are seldom over  $\frac{1}{2}$  chain per mile and the average error in height work is 10 feet. In very brushy country some tricks of the trade are introduced in the interest of speed, as sighting to the flash of a mirror or the metal note holder of the cruiser. In country of long

open slopes an alternative method is to take longer shots to noted objects, chain up, and compute the elevation.

Above is practice developed in the United States Forest Service. The cost is given as 12 cents per acre as a total for topography and cruise. Some commercial work is done on the same general plan, a five-chain tape being used and correction for distance made from tables in the field.

The accompanying map of mountainous land in Idaho shows at the left the topography along two miles of section line as developed by a survey for control purposes which surrounded four sections. This control work naturally is performed and checked in advance of the detail work. To the right the topography of the greater part of the area has been filled in, but a strip left blank indicates how it is built up, from parallel lines 10 chains apart crossing the territory. This map is completed in the field, a board and outline section sheets facilitating the purpose.

This method, though developed in special conditions in the West, promises, with some of its modifications, to win a considerable field of employment.

## SECTION VIII

### ADVANTAGES OF A MAP SYSTEM

Following are the advantages which a good set of maps renders to a large business concern. To secure these a good man will be required in the field to keep up lines, map the cutting of successive years, and watch the condition of the timber.

1. Great saving in the aggregate can be effected through the detection of small losses, such as windfalls and insect depredations, also by finding bodies of unhealthy timber, and as far as possible having such material cut and hauled.

2. The location of all sorts of roads, whether railroads, logging roads, or supply roads, is greatly facilitated. Exploring is saved, and distances are accurately known.

3. Operations can be planned and largely controlled from a center with all sources of information at hand.

The timber resources are known; also their location, and all related facts. The cut can be located for years ahead to the best advantage, so as to make driving and the hauling of supplies, for instance, come cheapest and handiest.

4. A map system preserves information about the land. An old lumberman or cruiser has a lot of information in his head that is lost to a business when he dies or steps out, unless it is fixed in some permanent form.

5. A concern knows what it is possessed of, and has that information in the form most easily taken in by all intelligent men whom it may be desirable to inform; for instance, stockholders, and possible money lenders.

6. A good map system in a business may pay for itself at the first change of management. A new manager coming into a business is in the hands of his employees for years until he can get first-hand knowledge of his country. With the aid of a good map system working command of a big property may be had in a year.

7. A reliable map system followed up for a term of years through a series of pictures of the land furnishes a record of its growth, and so enables a concern to grapple with the question of future supplies.

PART III

LOG AND WOOD MEASUREMENT

## PART III. LOG AND WOOD MEASUREMENT

SECTION	I. CUBIC CONTENTS . . . . .	137
SECTION	II. CORD WOOD RULE . . . . .	138
SECTION	III. NEW HAMPSHIRE RULE . . . . .	138
SECTION	IV. BOARD MEASURE . . . . .	139
	1. General . . . . .	139
	2. Scribner and Decimal Rules . . . . .	141
	3. Spaulding or Columbia River Rule . . . . .	141
	4. Doyle Rule . . . . .	141
	5. Maine Rule . . . . .	142
	6. New Brunswick Rule . . . . .	144
	7. Quebec Rule . . . . .	145
	8. Theory of Scale Rules and Clark's International Log Rule . . . . .	145
SECTION	V. NEW YORK STANDARD RULE . . . . .	147
SECTION	VI. SCALING PRACTICE . . . . .	148
SECTION	VII. MILL TALLIES . . . . .	151
SECTION	VIII. CORD MEASURE . . . . .	157

## PART III. LOG AND WOOD MEASUREMENT

### SECTION I

#### CUBIC CONTENTS

THE simplest way to measure the contents of a log is to take its length and mid-diameter and ascertain the cubic contents of a cylinder having those dimensions. Bark may be taken in or left out. By the use of a caliper and tape, a very close result may be had on logs that are not too long, provided care is taken either by inspection or by cross measurement to get a true mid-diameter. Trees cut nearly full length are given as a rule too large a value when measured in this way, — larger, that is to say, than their actual cubic contents. The percentage of overrun for large spruce cut off at 5 to 8 inches diameter in the top is about 6 per cent of their true volume.

When logs are placed in a pile the best that can be done is to use a diameter which is an average between the diameters of the ends, swell at the stump, if present, being disregarded.

First among the tables for log measurement given in the back of this work is a table of cylinders with contents in cubic feet, standard measure. The lengths in feet are given in the first vertical column, the diameters in inches on the upper horizontal line, and the contents of any log is read off opposite its length and beneath its diameter. If the length is not given, add together such lengths as will make it up. Thus a log 12 inches in diameter and 47 feet long has the contents of a log 40 feet long + that of a log 7 feet long, or  $31 + 5.5$  cu. ft. = 36.5 cu. ft.

For practical purposes results near enough will be had if fractions of inches more than  $\frac{1}{2}$  inch are taken as of the inch above, and fractions of  $\frac{1}{2}$  inch and less are disregarded.

For convenient use in scaling, these figures should be stamped on the bar of a log caliper. They may be so arranged on a bar as to throw out a fair proportion for bark.

This system of log measurement is in actual use in but one business concern, so far as known to the writer, yet it is the simplest and most natural measurement for logs that are to be converted into pulp, shingles, excelsior, etc. It is not a difficult matter to arrange a factor or factors for converting cubic measure into board measure.

## SECTION II

### CORD WOOD RULE

The figures given in the table on page 239, those for cord measure, are not cubic feet of solid wood, but what have been called "stacked cubic feet"; — the space which wood will occupy in a pile. 128 of these make a cord. Like the preceding, these figures are ordinarily placed for convenient use on the bar of a caliper rule.

These figures have been long and widely tested in practice, and when used as designed have given satisfaction. Logs should not be measured in too long lengths, for whole trees measured in this way may not hold out. Again, small, crooked, and knotty timber will pile up rather more cords than the rule gives. On a good quality of pulp wood these figures yield just about the same return as the results of piling. For further details see Section VIII, on cord measure.

## SECTION III

### THE NEW HAMPSHIRE RULE

The New Hampshire Log Rule is exactly the same as the last in principle, only an artificial unit of measure has been created. The "cubic foot" of New Hampshire log measure is 1.4 times the cubic foot of standard measure, and nearly twice the foot of the cord wood rule. The New Hampshire law regarding the matter is as follows:

All round timber, the quantity of which is estimated by the thousand, shall be measured according to the following rule: A

stick of timber sixteen inches in diameter and twelve inches in length shall constitute one cubic foot, and the same ratio shall apply to any other size and quantity. Each cubic foot shall constitute ten feet of a thousand board feet.

This rule is extensively used in scaling spruce in Maine, New Hampshire, and Vermont. A broad caliper bar is stamped with the figures, and the stiff iron jaws attached throw out  $\frac{3}{4}$  inch from the diameter for bark. The diameter is taken in the middle of the log, and in ordinary practice logs of any length are measured as one piece. The values given by the rule run parallel to actual cubic contents and the rule is therefore a fair one as applied to pulp wood. It is not a satisfactory measure of the yield of logs at the saw, small logs being for that purpose overvalued and very large logs undervalued. As with cubic measure, however, its values could be readily converted into board measure by the use of different factors for logs of different sizes.

It is now the uniform practice wherever the New Hampshire rule is in use to take 115 feet by the rule for 1000 feet of lumber.

## SECTION IV

### BOARD MEASURE

1. **General.** A board foot is a piece of sawed lumber 12 inches square and one inch thick, or any piece, as  $3 \times 4$  or  $2 \times 6$ , which if reduced to 1 inch thickness has 144 square inches of area. It is properly the unit of sawed lumber, and there must always be more or less difficulty in adjusting it to the measurement of logs.

There are a large number of rules in the country to-day purporting to give the contents of logs of given dimensions in feet, board measure. Among these rules there is wide variation in the value given to logs of the same dimensions. In the manner of their use, too, there is a good deal of divergence, resulting sometimes in dispute and loss.

The figures of eight rules in extensive use in the United States and Canada — the Scribner, the Doyle, the Decimal, the Maine, the New Brunswick, the Quebec, the

Spaulding, and the British Columbia — are printed in this work (see pages 243–260). The International rule, devised by Dr. Judson F. Clark, formerly forester of Ontario, is also given (page 254). In regard to these rules and their relation to log measurement and saw product several general observations may be made.

(1.) On sound, smooth, soft-wood logs when manufactured according to the best present practice, the figures of all the commercial rules are conservative with the exception of the Doyle rule on very large logs. This is especially true with reference to small logs.

(2.) Board rules give to large logs a greater valuation in proportion to cubic contents (actual amount of wood) than to small ones. Thus the Scribner log rule to 8-inch logs of small taper allows five feet per cubic foot of wood contents; to 16-inch logs seven feet, to 30-inch logs eight feet. This principle is a just one for logs that are in fact to be sawn, because the waste in manufacturing in the case of small logs is much greater, but on this account a board rule is not a just measure for logs designed for pulp or other such uses.

(3.) The rules are adapted to use on short logs with little taper. When logs are long enough to be cut in two for sawing, or to yield side boards for a part of their length, to derive contents from length and top diameter is not a fair thing. In such cases a second measure of diameter should be taken, and this can be done accurately only with a caliper. Allowance for “*rise*” or *taper*, whether for each log by judgment or according to some rule agreed upon, is more or less inaccurate and should be resorted to only in case of necessity. It may be said as a general rule that 20-foot lengths are as long as it is safe to scale logs in.<sup>1</sup>

On the other hand, since strongly tapering logs in almost every case are rougher than those of gentle taper, varying taper in logs of reasonable length is largely neutralized by quality.

(4.) There is wide variation in the details of scaling practice, and a trustworthy rule in consequence may, in the hands of an unskilled or careless man, give very unsatis-

<sup>1</sup> Except in the case of Pacific Coast timber.

factory results. In some matters, especially culling for defects, latitude must be allowed to the scaler. In general, however, practice is weak in the direction of strict mechanical accuracy. Reference is made to section VI following.

The method of construction, field of use, and relation to saw product of the above named rules are as follows:

2. **Scribner and Decimal Rules.** The figures of the original Scribner rule were obtained by drawing diagrams of the end sections of logs 12 to 48 inches in diameter and the boards which in the mill practice of the time could be sawed out of them. It is a very old rule and in wide use. As printed, extended down to 6 inches, it is the legal rule in the state of Minnesota.

Omitting unit figures of the Scribner rule and taking the nearest tens has given the Decimal rule, so called, legal in Wisconsin and adopted by the United States Forest Service.

3. **Spaulding or Columbia River Rule.** This rule was derived by similar methods as the preceding,  $\frac{1}{8}$  inch being allowed for saw kerf. It is in more extensive use on the Pacific Coast than any other.

4. **Doyle Rule.** This rule was constructed by the following formula:—Deduct 4 inches from the diameter of

Diameter	No. Logs	Doyle Scale	Product	Overrun
6-8 in.	28	289	903	213%
7-9 in.	54	831	2159	159%
8-12 in.	101	2603	5471	110%
10-17 in.	104	6324	9976	58%
18-20 in.	90	15440	20215	31%
21-24 in.	126	30929	37744	22%
25-33 in.	31	11866	13368	12%

the log for slab, square  $\frac{1}{4}$  of the remainder, and multiply by the length of the log in feet. This is a very illogical rule and gives results widely varying from saw product in

logs of different sizes, though in a run of logs the results obtained may approximate a fair thing. Very small values are given to small logs, too small by far for normal logs economically manufactured, while beyond about 36 inches in diameter values are given that are above the product of the saw. It crosses the Scribner rule at 25 inches in diameter, the Maine rule at 34. A test made by Dr. J. F. Clark in 1905 in a Canadian band mill cutting sound, straight pine into boards resulted as shown on page 141.

The Doyle rule is in more general use than any other in the United States and Canada, and is the one printed in recent editions of Scribner's "Lumber and Log Book."

This rule has been combined with the Scribner into the **Doyle-Scribner rule**, the figures of the Doyle rule being taken for small logs where the Doyle figures are lower, and of the Scribner rule on the largest logs where these figures are less. This Doyle-Scribner rule has been used largely on hard woods.

5. **Maine**, also called **Holland Rule**. The figures of this rule were derived from diagrams. That is to say, circles 6, 7, 8, etc. inches in diameter were plotted and within these the boards that could be sawed, an inch thick with  $\frac{1}{4}$  inch for saw kerf. Not only the boards derived from the inscribed square were reckoned, but the side boards if they were as much as 6 inches wide. No rounding off of the figures was done, so they are a little irregular, but that takes care of itself in a run of logs.

This rule is used largely in Maine and to some extent elsewhere. It has been carefully tested at the saw, and the conclusions are as follows:—Sound spruce and pine logs 12 to 18 feet long, of best merchantable quality, manufactured at a circular saw cutting  $\frac{1}{4}$ -inch kerf will yield in the shape of inch boards just about the number of feet of edged lumber that the rule gives. A band saw will get more, and there will be a larger product if the logs are put into plank or timber. More will also be got the longer the logs run, up to the point where they are scaled in two pieces.

How sawing practice affects the product at the saw was clearly shown by a test made by the United States Forest

Service in various spruce mills of Maine. Some results of this test are given in tabular form. All logs were straight and sound, and exact conditions were as follows:

Band Mill No. 1,  $\frac{1}{8}$ -inch saw kerf, lumber cut just 1 inch thick. Mill run for economy and utmost product of long lumber, giving product of about 40 M daily.

Band Mill No. 2, same saw kerf. Mill run for speed rather than economy, product being 58 M a day.

Rotary Mill,  $\frac{5}{16}$ -inch saw kerf, lumber even inch thick.

Gang Saw,  $\frac{5}{32}$ -inch kerf, lumber even inch thick, logs sawed alive or through and through.

TABLE I. YIELD IN INCH BOARDS OF LOGS 16 FEET LONG AS SAWED IN DIFFERENT MILLS

Top Diam.	Band Mill No. 1 Logs turned	Band Mill No. 1 Sawed alive	Band Mill No. 2 Sawed alive	Rotary Sawed alive	Gang	Scale by Maine Log Rule
6 in.	30	26	20	18	24	20
7 in.	41	36	29	25	34	31
8 in.	53	47	39	35	43	44
9 in.	66	59	51	46	54	52
10 in.	81	73	64	59	67	68
11 in.	96	88	79	73	80	83
12 in.	112	106	95	89	94	105
13 in.	130	125	113	107	109	120
14 in.	149	. . .	133	127	126	140
15 in.	171	. . .	154	. . .	145	161
16 in.	196	. . .	178	. . .	165	179

TABLE II. PRODUCT IN INCH BOARDS OF LOGS OF DIFFERENT LENGTHS AS SAWED IN BAND MILL NO. 1

Shows how in careful practice yield increases relative to scale as the logs are longer.

Top Diam.	Lengths in Feet								
	8	10	12	14	16	18	20	22	24
6 in.	13	17	22	26	30	34	39	44	50
8 in.	25	32	39	46	53	60	68	76	84
10 in.	39	49	59	70	81	91	101	113	124
12 in.	54	68	83	97	112	126	141	156	172
14 in.	73	92	111	130	149	170	190	211	232
16 in.	95	120	145	170	196	223	250	278	306

TABLE III. PRODUCT OF MILLS WHEN SAWING DIMENSION STOCK, MOSTLY 2 AND 3 INCH PLANK

Overrun is the percentage by which the product exceeds the scale of the logs as given by the Maine log rule.

Band Mill No. 1			Rotary		
Lengths	Average Top Diam.	Over-run	Lengths	Average Top Diam.	Over-run
16 ft. and under	10 in.	24 %	16 ft. and under	10 in.	0 %
17-20 ft.	10 in.	23 %	17-20 ft.	10½ in.	6 %
21-24 ft.	8½ in.	37 %	21-24 ft.	12 in.	11 %
			25-28 ft.	9½ in.	15 %

**6. New Brunswick Rule.** This is the legal rule for scaling lumber cut on the crown lands of New Brunswick, and is generally employed for log measurement in that province. Its values are somewhat below those of the Maine rule.

When logs of a smaller top diameter than 11 inches are to be scaled, it is done under the following rule: A 7-inch

log contains 2 ft. B. M. per foot of length, an 8-inch log  $2\frac{1}{2}$  ft., a 9-inch log 3 ft., a 10-inch log 4 ft.

One notable thing about the New Brunswick rule is that taper is allowed for in lengths over 24 feet.

**7. Quebec Rule.** This is the legal rule for measuring logs in the province of Quebec. Values are close to the Scribner Rule; in many cases they are identical. The figures were derived by plotting.

**8. Theory of Scale Rules and Clark's International Log Rule.** The theory of the measurement of saw logs in board measure has been more carefully studied by Dr. Judson F. Clark<sup>1</sup> than by anyone else, and a rule called the International Log Rule was devised by him, on the basis of this reasoning, which he also tested at the saw. The main points in this study are as follows:

*Taper of Logs.* While logs exhibit a great variety of taper, it has been found (1) that rough logs taper more than clear, smooth logs, so that quality tends to neutralize taper; (2) that *average taper* does not differ greatly in different localities or with different species. This average taper as a result of much measurement is found to be safely 1 inch in 8 feet. This in modern economical mill practice increases the yield of lumber in the form of side boards, and the above stated allowance for taper is therefore introduced into the rule for all lengths over 8 feet.

*Crook and Sweep.* In this study due allowance was made for irregularity of surface, and crook averaging  $1\frac{1}{2}$  inches in 12 feet of length, found to be characteristic of white pine logs on the Ottawa River, was counted normal. Above the limit of  $1\frac{1}{2}$  inches in 12 feet, any given degree of crook was found to affect the product of small logs more than of large logs, and that in proportion to their diameters. That is to say, a crook of 3 inches in 12 feet throws out twice as great a percentage from a 10-inch log as from one 20 inches in diameter.

*Shrinkage and Seasoning.* Logs are commonly scaled green, while sawed lumber must hold out on a survey made when it is dry. In computing his rule Dr. Clark figured that boards would be cut  $1\frac{1}{8}$  inch thick to allow for this.

<sup>1</sup> See Forestry Quarterly, Vol. IV, No. 2.

*Saw Kerf.* This loss in logs of different sizes is proportional to the area of their cross-section, or to the square of the diameter. It varies in proportion to the thickness of saw kerf as well. As embodying an average of good present practice,  $\frac{1}{8}$  inch was allowed.

*Loss in Edging Lumber.* This includes not only that portion of a log which is thrown away in the form of edgings, but also the fractions of inches in the width of boards, which in Dr. Clark's studies were uniformly thrown off. It is counted to be in all logs proportional to the surface, or, what amounts to the same thing, to the diameter. Counting boards to be merchantable down to the size of 2 ft. B. M., Dr. Clark found that an allowance of .8 foot board measure for each square foot of surface under the bark, or, what amounts to much the same, a layer .8 inch in thickness around the surface, would justly allow for this waste.

*Formula for the Rule.* The above elements being put into mathematical form with D representing top diameter inside bark, there is obtained for 4-foot sections the formula

$$(D^2 \times .22) - .71 D = \text{contents B. M.}$$

*Adaptation to Other Conditions.* The product for other widths of saw kerf than  $\frac{1}{8}$  inch may be obtained by applying the following per cents:

For $\frac{7}{32}$ inch kerf add	1.3 per cent.
For $\frac{3}{16}$ inch kerf subtract	.5 per cent.
For $\frac{1}{4}$ inch kerf subtract	9.5 per cent.
For $\frac{5}{16}$ inch kerf subtract	13.6 per cent.
For $\frac{3}{8}$ inch kerf subtract	17.4 per cent.
For $\frac{7}{16}$ inch kerf subtract	20.8 per cent.

Should the  $\frac{1}{16}$ -inch allowance for shrinkage not be made in the mill practice in question, this may be allowed for in a similar way. According to Dr. Clark's assumptions, each board with its saw kerf means  $1\frac{3}{8}$  inch in thickness taken out of the log.

If mill practice in other ways is not so economical as the rule presupposes, that is to say, if logs are sawed with more waste in slab and edging than has been assumed, or if logs vary in taper and straightness from the standard, that is considered by Dr. Clark to be proportional to the

surface or diameter, and he recommends that it be allowed for by making a comparison between the scale and mill product, and then adjusting the zero mark on the scale stick more than one inch from the inch mark on the stick in accordance with the results of that comparison. Dr. Clarke's rule will be found on page 254 in the same section with the other board rules.

## SECTION V

### THE NEW YORK STANDARD RULE

In northern New York logs are cut as a rule 13 feet long, and a log of that length and 19 inches in diameter at the top, inside bark, is the common unit of log measurement. It is called a "*market*" or "*standard*," and logs of other dimensions are valued in proportion.

The "*standard*" is thus another artificial unit of log measurement, more artificial, perhaps, than any other here dealt with. Standard measure in logs of the same length runs very close to cubic measure. Thus a log 19 inches in diameter at the top and 13 feet long has 26 cubic feet in it; four logs  $9\frac{1}{2}$  inches in diameter and 13 feet long, also making one standard, contain the same amount of wood approximately, while a 38-inch log of the same length has four standards and 104 cubic feet of contents. A log 26 feet long, however, has more than twice the wood contents of a 13-foot log on account of taper. For that reason the use of standard measure outside of a region where short standard lengths are cut would be likely to make trouble.

Standard measure does not run parallel to board measure or to the yield of logs of different sizes at the saw. The standard log, — a log, that is to say, 19 inches in top diameter and 13 feet long, — scales by the Scribner rule 195 feet, and, in practice, five standards are often reckoned as the equivalent of a thousand. Four  $9\frac{1}{2}$ -inch logs, together making one standard, scale but 144 feet by the rule, or seven standards to the thousand, and the actual ratio between standards and thousands is stated to run all the way from 4 to 14.

The ratio between cords and standards is nearly constant in logs of all sizes if cut of equal length. In the Adirondack woods 2.92 standards are commonly reckoned as one cord.

## SECTION VI

### SCALING PRACTICE

Logs are best scaled when they are being handled over, as on a landing or mill brow, for then all parts can be seen and got at. Measurement in the pile, especially for long logs, is both difficult and unsatisfactory.

1. **Length.** A tape worked by two men is an accurate measure of length. Short logs may be accurately measured with a marked pole, and for long logs a carefully adjusted wheel with brads in the ends of its spokes is cheap to use and reasonably accurate. Measurement with a four-foot stick has a very wide range of accuracy, according to the way it is done.

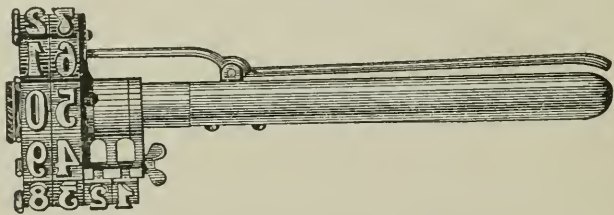

GERMAN NUMBERING HAMMER

Valuable timber cut into standard log lengths is commonly allowed two inches extra to permit trimming at the saw, this amount being disregarded in the scale. If logs are cut without measuring, in which case they are as likely to be ten inches over foot lengths as two inches, the extra inches are commonly thrown off just the same. That practice, however, means in 16-foot logs a loss of  $2\frac{1}{2}$  per cent on the scale or the timber. On 30-foot logs, it means  $1\frac{1}{2}$  per cent.

2. **Diameter.** The diameter measure for any board rule is obtained at the small end of the log and inside the bark. It is important in large and valuable timber that an average diameter be taken. In dealing with fractional inches,

there is a variety of practice. Some scalers read uniformly from the inch nearest the exact diameter; some disregard all fractional inches and take the next inch below; some vary the practice according to length and taper of the individual logs.

Probably, the most just practice to follow, as a general rule, is to throw off all fractions of inches up to and including one half inch, and to read fractions over one half as of the inch above. This practice, in logs under 16 inches in diameter, gives results from 7 to 10 per cent greater than if all fractions of inches are thrown out.

**3. Culling for Defects.** Defects in logs consist in irregularity of form, in shakiness, and in decay. Knots are not properly considered as defects, but as a factor in general quality. All these matters vary with the species, with the locality, and with the individual log. They are matters which have to be dealt with locally and individually, and little can be written that is likely to be of service and not liable to do more harm than good.

The **curved or sweeping form** is a common defect in logs. Scalers frequently have rules for allowing for it, but these differ so widely that they cannot be transcribed here. (See page 145 for the result of this defect in logs of different sizes.)

**Irregular crooks** in logs cannot be classified. A man can sight along a log and estimate what proportion of it can be utilized by the straight cuts of a saw, and this guided by mill experience is the only way of dealing with the matter.

**Seams** caused by frost and wind form another class of defect, more frequent in northern woods and in trees grown on exposed places. Sometimes these are shoal and have little or no effect on saw product. Sometimes they reach nearly or quite to the heart of a log.

A fairly general practice on northern spruce cut for saw-mill use is to discount 10 per cent for straight, deep seams, and for twisting seams up to 33 per cent, or even to throw out the whole log.

It is to be remarked that these defects have, when reckoned in percentage, a far *greater effect on small logs than on large ones*. Thus a three-inch sweep in a 15-inch, 12-

foot log takes but a small percentage out of its total yield at the saw, while a 6-inch log with the same sweep is practically useless for full length, edged lumber. Again, strong taper may largely neutralize the effect of considerable irregularity in outside form. Lastly, in practical scaling, *a certain amount of irregularity in outside form must be considered normal* and be taken care of by the conservatism of the log rule.

**Shakiness** in logs is far more frequent in some species than in others. Thus hemlock is largely affected by it, while there is very little of it in spruce. In large measure, it should be considered as an element of quality, affecting the grade of the product, not a defect affecting the scale of the logs. When, however, a considerable section of a log is rendered worthless, it should be thrown off in the scale. How much to throw off is a matter of judgment and of mill experience.

**Decay** may be complete, utterly destroying the value of a whole log or a section, or it may be partial, allowing the production of a low grade of lumber. Decay varies much according to species and locality, and it occurs in various forms. Of the northern soft-wood trees, fir is most liable to unseen defects, — a log perfectly sound to all outside appearance may “open out” very poor at the saw. To a less extent white pine in some localities is affected in the same way.

Generally, however, the ends of a log or some mark on its surface, such as rotten knots, “punks,” and flows of pitch give indication to the practiced eye of defect beneath. How much to allow is then a matter of judgment based on mill experience.

The following table<sup>1</sup> has been made up, giving the loss due to round center defects extending through or affecting the full length of a log. For four- or five-inch defects, it amounts to the same thing as throwing out a scantling having the same side as the hole has diameter.

As stated at the start, careful mill training is the only safe basis for the correct culling or discounting of logs. Some scalers have that; some do not, and have to rely either

<sup>1</sup> Graves' “Forest Mensuration.”

TABLE OF LOSS BY HOLES OR ROT NEAR THE CENTER  
OF LOGS, GOOD FOR DEFECTS MORE THAN 4  
INCHES FROM THE BARK

Diam. of Hole	Length of Logs in Feet					
	10	12	14	16	18	20
Inches	Board Feet					
2	5	6	7	8	9	10
3	9	11	13	15	16	18
4	14	17	20	23	25	28
5	20	24	28	32	36	40
6	27	33	38	44	49	55
7	36	43	50	57	65	72
8	45	54	63	72	81	90
9	56	67	78	89	100	112
10	67	81	93	107	120	133

on arbitrary rules or on guesswork. Proper discount may vary greatly, too, with the mill practice and product. A mill with a box factory attached, or sawing round-edged stuff which is measured regardless of crooks, wastes little or nothing on account of defective form. For a mill which can market only three-inch deals at a profit, an entirely different system of scaling is appropriate.

## SECTION VII

### MILL TALLIES

Thousands of unrecorded tests of scale rules have doubtless been made at the saw, using local and current scaling and sawing methods. During the last few years a number of such tests have been made under stated conditions so carefully guarded that they may serve a general purpose. Reference is made to the tests recorded on pages 143 and 144 of this work. The following also are reliable and of interest to northern workers in timber.

The wide variation in the yield of logs as sawed under different conditions is a matter of great importance in several ways to the worker in timber, chiefly, perhaps, for its bearing upon timber estimates. The relative compe-

tence of sawyers is one cause of this, and that, according to careful mill men, may readily amount to 10 per cent. Then market demand affects the matter, some mills being so situated that they can market only the larger sizes of lumber. The type of saw employed and the methods of handling on the carriage also have their effect.

TABLE I

*Yield in inch boards, squared, of second growth white pine logs. Based on 740 logs; study by Harvard Forest School.*

Growth extra tall and smooth; large and small trees in the stand, which was cut clean; logs with 2 in. crook or over thrown out. Sawed by circular saw cutting  $\frac{1}{4}$ -inch kerf. In scaling, fractions of inches up to .5 were thrown off, fractions of .6 and over taken as if of inch above. Boards merchantable down to 2 feet, surface measure; some wane allowed.

Top Diameter	Yield B.M.	
	12-foot Logs	14-foot Logs
5 inches	14	15
6 inches	20	23
7 inches	26	30
8 inches	34	39
9 inches	43	50
10 inches	53	61
11 inches	67	76
12 inches	81	90
13 inches	95	105
14 inches	110	122
15 inches	128	139
16 inches	147	160
17 inches	170	
18 inches	202	

A practice that in some localities of recent years has greatly increased the merchantable product of logs is that of sawing waney or round-edged boards. Portable mills in southern New England sawing lumber for boxes or finish follow this practice largely, and stationary mills in many localities have a box or other saw to which they can turn over the small and crooked logs for this most economical

form of manufacture. When boards in this form are surveyed they are measured at the average width, inside bark, on the narrow side, without discount for crooks.

This practice has brought about great economy in the use of timber, and when done with thin saws, has secured from logs a far greater product than current scale rules give. Several of the tables given herewith are of special interest in this connection. In all these tables top diameter means diameter of the upper end of the log inside bark.

TABLE II

*Yield in inch boards of second growth white pine logs, sawed with a circular saw cutting  $\frac{1}{4}$ -inch kerf. Greater part of boards not edged, but measured for width at an average width, inside bark, on narrow side, without discount for crook.*

*Based on 1180 logs. From Massachusetts State Forester.*

Top Diam. Inches	Length of Log — Feet			
	10	12	14	16
	Vol. Bd. ft.	Vol. Bd. ft.	Vol. Bd. ft.	Vol. Bd. ft.
4	9	13	17	21
5	13	17	21	26
6	17	22	27	32
7	23	29	35	40
8	30	37	44	51
9	39	47	55	64
10	48	58	68	79
11	58	70	82	98
12	69	83	97	115
13	80	96	113	136
14	92	111	131	158
15	104	129	150	180
16	117	146	170	205
17	131	165	192	230
18	...	184	220	256

As the edged lumber was taken from the larger and straighter logs and after those logs had been sided on the carriage and turned down, the yield was probably as large as if all boards had been left round-edged.

TABLE III

*Same logs but grouped according to mid diameter outside bark.*

Mid Diam.	Length of Log — Feet		
	10	12	14
Inches	Contents — Board Feet		
5	7	8	10
6	10	13	16
7	15	19	23
8	22	27	31
9	28	34	40
10	35	43	50
11	44	53	63
12	53	64	77
13	61	76	91
14	70	88	106
15	82	104	125
16	95	119	144
17	109	136	163
18	...	155	184
19	...	173	204
20	...	193	226
21	...	211	247
22	...	235	273
23	...	256	298
24	...	281	328
25	...	304	355
26	...	...	384

The figures of the above tables were closely confirmed, except in the smallest sizes of logs, by similar figures obtained by the U. S. Forest Service for the Forest Commission of New Hampshire. The saws in this latter test cut  $\frac{1}{4}$ -inch kerf; 60 per cent of the product was round-edged stuff, the balance being squared; 70 per cent of the lumber was cut 1 inch thick, the balance  $2\frac{1}{8}$  and measured as 2 inches. In the sizes under 8 inches the Massachusetts mills cut somewhat closer.

TABLE IV

*Comparison of Maine Log Rule and results of sawing as shown in Tables I and II. 12-foot logs.*

Top Diameter Inches	Maine Log Rule	Results of Sawing	
		Edged Lumber Table I	Round-edged Lumber Table II
4	...	...	13
5	...	14	17
6	15	20	22
7	23	26	29
8	33	34	37
9	39	43	47
10	51	53	58
11	62	67	70
12	78	81	83
13	90	95	96
14	107	110	111
15	121	128	129
16	134	147	146
17	154	170	165
18	174	202	184

TABLE V

*Yield in  $\frac{5}{8}$ -inch boards of pine logs 4 feet long (+ 2 inches for trimming).*

Diameter	Yield	Basis
	Surface Measure	
4 inches	4 feet	3 logs
5 inches	6 feet	48 logs
6 inches	9 feet	121 logs
7 inches	13 feet	109 logs
8 inches	17 feet	75 logs
9 inches	22 feet	84 logs
10 inches	28 feet	40 logs
11 inches	34 feet	36 logs
12 inches	41 feet	21 logs
13 inches	49 feet	11 logs
14 inches	57 feet	6 logs
15 inches	66 feet	4 logs
16 inches	75 feet	6 logs

Log diameter taken at top end, inside bark. Saw kerf  $\frac{1}{8}$  inch. Boards not edged, but measured at an average width on narrow side. From Massachusetts State Forester.

A cord of pine wood sawed and measured in this fashion yields about 1000 feet of box boards. Sawed one inch thick, it is counted by Massachusetts box board men to yield about 650 feet surface measure.

TABLE VI

*Yield in round-edged boards of second growth hard wood logs 12 feet long cut  $\frac{1}{8}$  inch thick with circular saw cutting  $\frac{1}{4}$ -inch kerf. Based on 1831 logs.*

*Grouped according to top diameter.*

*Grouped according to mid diameter.*

Top Diameter Inside Bark	Yield, Surface Measure, of 12- foot Logs
4 inches	8 feet
5 inches	11 feet
6 inches	16 feet
7 inches	22 feet
8 inches	30 feet
9 inches	39 feet
10 inches	51 feet
11 inches	65 feet
12 inches	82 feet
13 inches	100 feet
14 inches	120 feet
15 inches	141 feet
16 inches	165 feet
17 inches	192 feet
18 inches	222 feet

Mid Diameter Outside Bark	Yield, Surface Measure, of 12- foot Logs
6 inches	11 feet
7 inches	15 feet
8 inches	21 feet
9 inches	29 feet
10 inches	37 feet
11 inches	49 feet
12 inches	61 feet
13 inches	75 feet
14 inches	91 feet
15 inches	107 feet
16 inches	126 feet
17 inches	143 feet
18 inches	165 feet
19 inches	187 feet
20 inches	210 feet

From New Hampshire Forestry Report for 1905-1906.

## SECTION VIII

## CORD MEASURE

The exact legal definition of the term "cord" varies in different localities. For the present purpose it is a pile of wood 8 feet long and 4 feet high, with the top sticks rising somewhat above the line, the sticks themselves sawed 4 feet long or chopped so as to give an equivalent. Such a pile occupies 128 cubic feet of space. A cord foot is  $\frac{1}{8}$  of a cord, or a pile 4 feet high, 4 feet wide, and 1 foot long.

The actual solid contents of the wood which a piled cord contains depends on a number of factors. First is the care used in piling, a matter which need only be mentioned here. Other factors are the straightness and smoothness of the wood, its size, assortment, and whether split or not.

In regard to the first of these factors, while it is perfectly evident that straight, smooth, well-trimmed wood must pile closer than its opposite, no hard and fast rules can be given. Taking round wood of given quality, the following rules can be laid down:

1. Large wood piles closer than small wood.
2. The same wood put up in one pile with sizes mixed occupies a little less space than if the larger and smaller sizes are piled separately.
3. The effect of splitting varies much with the quality. Smooth, straight-grained wood when split may be packed into the same space that it occupied before. On the other hand, small or crooked wood when split piles much more loosely.

In regard to the actual solid contents of a piled cord, the following rules will approximately hold.

1. Smooth, round wood 8 inches and up in diameter, such, for instance, as the best pulp wood, has .8 of its contents in solid wood or yields 102 cubic feet solid to the cord. White birch of best quality will yield nearly or quite the same.

2. Small pulp wood from 3 to 8 inches in diameter contains about .7 of its stacked volume in solid wood, or 90

cubic feet to the cord. Smooth hard wood yields about the same.

3. Still smaller round wood, wood that is crooked and knotty, and good split hard wood contains in solid wood about .6 of the outside contents of the pile or 77 cubic feet per cord.

4. Small, crooked wood cut from limbs may run down as low as 27 solid cubic feet per cord.

5. <sup>1</sup>The longer a lot of wood is cut, the greater will be the vacant space left in piling. Fair sized pulp wood, for instance, which when cut 4 feet long will measure a cord, if cut in 2-foot lengths will pile up in 2 to 3 per cent less space. The same wood, on the other hand, if cut 8 feet long and measured in the pile will measure nearly 6 per cent more; if 12 feet long, about 12 per cent more.

Wood in thorough air-drying shrinks about 10 per cent on the average, hard woods as a rule more than soft. If wood checks and cracks freely, something like half the total shrinkage is taken up in this form. Two inches extra height in the pile are commonly allowed on green wood in Massachusetts.

**To Measure Wood in Cords.** When the wood is 4 feet long, measure the height and length of the pile in feet, multiply together, and divide by 32. The result will be contents in cords. If the wood is more or less than 4 feet long, multiply length, width, and height of the pile together, and divide by 128. If wood is piled on sloping ground, the length and height should be measured perpendicular to one another.

For measurement of logs into cord measure, see page 138.

The French cord of the Province of Quebec is 8' 6"  $\times$  4'  $\times$  4' 3", containing, therefore, 144 cubic feet, as against 128 for the cord current elsewhere.

<sup>1</sup> See Zon on this subject in Forestry Quarterly, Vol. I, No. IV.

PART IV  
TIMBER ESTIMATING

## PART IV. TIMBER ESTIMATING

SECTION	I.	INTRODUCTION . . . . .	161
SECTION	II.	INSTRUMENTAL HELPS . . . . .	162
SECTION	III.	HEIGHT MEASUREMENT . . . . .	165
SECTION	IV.	VOLUME TABLES AND TREE FORM . . . . .	167
SECTION	V.	PRACTICE OF TIMBER ESTIMATING . . . . .	173
	A.	Small and Valuable Tracts . . . . .	174
	B.	Larger and Less Valuable Tracts . . . . .	186
		1. Type and Plot System . . . . .	187
		2. The Strip System . . . . .	188
		3. Line and Plot System . . . . .	192
	C.	Summary . . . . .	195
	D.	Pacific Coast Methods . . . . .	196

## PART IV. TIMBER ESTIMATING

### SECTION I

#### INTRODUCTION

METHODS of estimating timber vary greatly in different regions and with different men. They vary also with the value of the timber involved and with the purpose for which the work is done. In this last connection cost is a guiding principle; in general, that method of doing a piece of work is best which secures a result sufficiently accurate for the purpose with the smallest expenditure of time and money.

**Lump Estimate** by the eye has not gone out of use, and in fact never will cease to be employed. The immediate judgment that a good lumberman forms, simply by walking through a piece of timber, that it contains a hundred thousand, a million, or ten million feet, is for many purposes close enough to the mark.

Similarly an experienced man, in timber of a kind with which he is familiar, forms an idea by direct impression of how much a piece of land will yield per acre. The men who can do that are more numerous than those who are able to judge the whole piece. The faculty is easier to acquire, and in general the results are safer and more reliable.

Such estimates as these are indispensable in actual business. Frequently they enable a man to pass correctly upon a proposition for purchase or sale. But while their necessity and their reliability within limits may be admitted, no illusions should be indulged in with regard to them. For one woodsman who can actually give a close and reliable estimate after these methods, there are many who only think they can; nothing is better known in the timber business than widely variant and totally erroneous estimates of standing timber. Further, a man

who uses these methods is frequently very lame when he gets into a country with which he is unfamiliar. Lastly, when time consumed and training involved are considered, estimates of this nature may not be the cheapest by any means.

There is a general tendency among timber estimators, commendable in the main on the ground of safety and conservatism, to put their figures below the mark. As for the general degree of accuracy obtained, there seems to be no reason founded on experience this side of the Atlantic to greatly change the verdict of experience in Europe<sup>1</sup> that good and experienced men in timber with which they are familiar are liable to errors up to 25 per cent.

It is true, moreover, that the weakness of these traditional methods is generally recognized. More careful and elaborate methods are in fact practiced in many sections of the country, and the area is fast extending in which the treatment demanded by the situation is not really an estimate but a survey.

## SECTION II

### INSTRUMENTAL HELPS

The helps that may be used in the survey of standing timber are as follows:

#### 1. FOR DIAMETER MEASUREMENT

**Calipers** for measuring the diameter of trees may be constructed by the woodsman himself, or they can be purchased of dealers. The best are made of light-colored hard wood and have the inches plainly marked on both flat sides of the bar. The jaws are detachable for convenience in transportation, and the sliding arm is so fitted with adjustable metal bearings that it is truly square and gives a correct diameter when pressed firmly against a tree or log.

Substitutes for the caliper, useful in some circumstances, are the **Circumference Tape**, a steel tape so graduated that when a circumference is measured a diameter is read,

<sup>1</sup> Schlich's "Manual of Forestry."

and the **Biltmore Stick**. This last is in construction a wooden bar of about the dimensions of an ordinary scale rule; in use it is held horizontal, tangent to the tree being measured, and at the natural (but a constant) distance from the eye of the observer. Then, one end of the stick being aligned with one side of the tree, where the line of sight to the other side cuts the stick it is graduated for the given diameter.<sup>1</sup> Both instruments have proved serviceable on the Pacific Coast, where the timber is so large that a caliper is cumbersome, and because of their portability they have a field of use elsewhere. They are not, however, as quickly manipulated as the caliper in steady work on timber of ordinary dimensions.

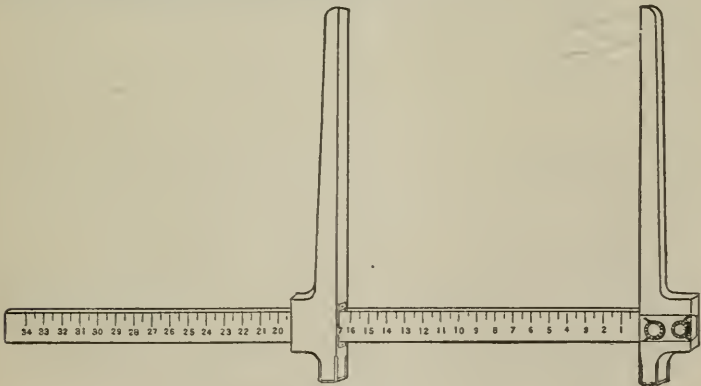

TREE CALIPER

## 2. COUNTER OR TALLYING MACHINE. TIMBER SCRIBE. BARK BLAZER

These simple little instruments, the last of which can be home-made if necessary, are very serviceable in forest work, particularly in timber estimating.

## 3. THE DENDROMETER

The dendrometer is an instrument for measuring the diameter of a tree at a considerable distance above the ground. There are several forms of this instrument, most of them costly and complicated, that are employed in scientific investigation. With these the practical woods-

<sup>1</sup> See Appendix on theory and accuracy of this instrument.

man has no concern. Such a man when he wishes to know the diameter of a standing tree at a point out of reach will ordinarily either estimate it or cut the tree down.

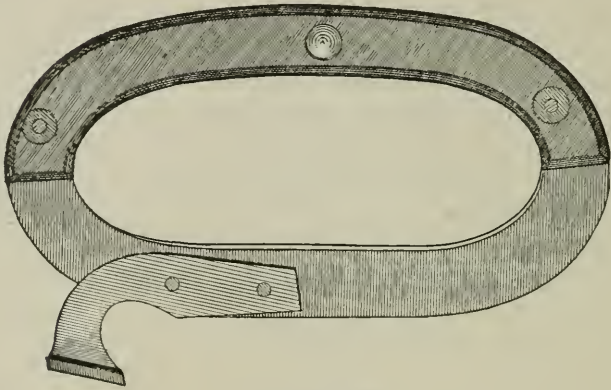

BARK BLAZER

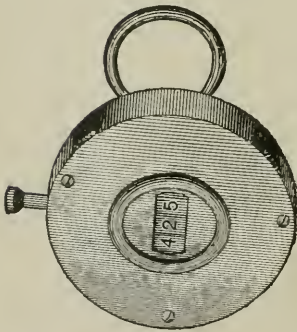

COUNTER

Occasionally, however, timber may be met with which is of sufficient value for special purposes to require measurement in this way. In such a case the engineer's transit may be employed, and by its aid it is not a difficult matter to determine either the height at which any given diameter is attained or the diameter at any given height. A very simple little instrument for diameter measure-

ment has been devised, which is described by its inventor as follows:<sup>1</sup>

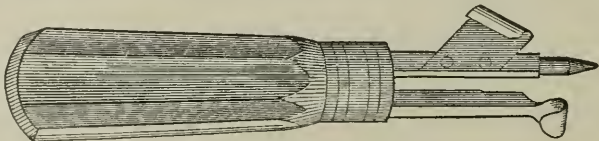

TIMBER SCRIBE

“The Biltmore pachymeter is used in connection with a target or piece of board graduated in inches, marked

<sup>1</sup> Forestry Quarterly, Vol. IV, p. 8.

black and white, which target is fixed horizontally at any point desirable at the base of the tree.

“The instrument itself consists of a piece of metal about 18 inches long and  $1\frac{1}{2}$  inches wide, containing a longitudinal slot about  $\frac{1}{4}$  inch wide and 17 inches long. The edges of this slot must be strictly parallel. Its actual width is entirely irrelevant from the mathematical standpoint.

“It might be stated that any stick or pole, even a walking-cane, having parallel edges, will answer the purpose of establishing and measuring upper diameters. The Biltmore pachymeter is merely a device convenient to handle.

“The observer holds the pachymeter pendulum fashion by the hand of the outstretched arm in a position parallel to the tree trunk, and moves the instrument backward or forward until the edges of the slot cut off even with the desired diameter shown on the target. Then, the eye following upward along the trunk and sighting through the slot, that point on the tree bole is readily obtained where the bole cuts off with the edges of the slot. The position of this point above ground can be ascertained easily with the help of any hypsometer.”

### SECTION III

#### HEIGHT MEASUREMENT

There are many methods of measuring the height of trees. As serviceable as any are the following:

1. Windfalls are often of great assistance in ascertaining the height of timber.

2. A pole 15 or 20 feet in length may be set up alongside the tree to be estimated and then, standing some distance away, the cruiser may run his eye up the tree and judge how many times the length of the pole will be contained in it. A pencil held erect at arm's length in range of the pole and then run up the tree will help the eye in making the judgment.

3. A cane or staff may be used on the principle of similar triangles. Hold the staff firmly in the hand with the arm straight and horizontal. Swing the end of the staff down

by the face and adjust the hold till the end of the staff just comes by the eye. The distance from the eye to the staff and from the hand up to the end of the staff are now equal. Go off from the tree to be measured, holding the staff erect, until you can sight by the fist to the base of the tree and by the top of the staff to the top of the tree. Pace or measure to the tree and this will give its height.

4. The Abney clinometer, shown on page 93 of this work, may be used for height measurement in much the same manner. Set the level tube at an angle of  $45^\circ$  with the line of sight and go off from the tree on a level with

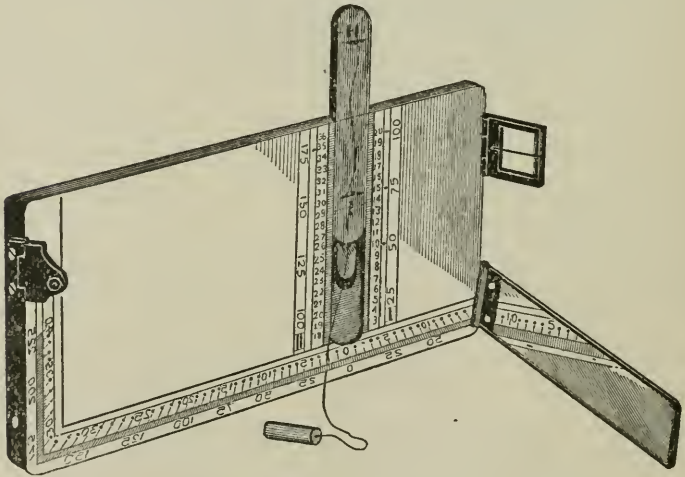

FAUSTMANN'S HEIGHT MEASURE

its base until, sighting at the top of the tree, you see by the bubble that the tube is level. The distance from the observer to the tree is then equal to the tree's height.

5. A second method employing the same instrument is as follows: Stand at a point where both the top and the base of the tree can be seen and at some convenient distance from it, as 100 feet. Sight to the top of the tree and observe the angle of inclination, and again to the base of the tree, observing that angle also. Go into the table of tangents with the angles in turn, find the decimals corresponding, and multiply by the length of base. The sum of the two figures is the total height of the tree.

*Example:* Standing 80 feet from a tree, the angle to the top is found to be  $31^\circ$  and that to the base  $8\frac{1}{2}^\circ$ , of depression. From the tables the tangent of  $31^\circ$  is found to be .6009; multiplying this by 80 gives 48 feet for the height of the tree above the level of the eye. Again the tangent of  $8\frac{1}{2}^\circ$  is found from the tables to be .1495 and this multiplied by 80 gives 12 feet.  $48 + 12 = 60$  feet, the total height of the tree.

6. Faustmann's height measure works in much the same manner, but gives the desired height directly without the use of tables. This instrument may be had of dealers at a cost of from \$6.50 up. It is compact, not complicated, and will be found of great service in estimating.

## SECTION IV

### VOLUME TABLES AND TREE FORM

A competent woodsman can tell from the looks of a tree somewhere near what it will scale, saw out, or yield in cord wood according to the practice with which he is familiar, and this without any measurements. Or a caliper may be used instead of the eye for diameter, and some kind of determination made of the height of the tree or the length and size of the logs into which it may be cut. The point of such judgment and measurements as a rule is their wider application. The single tree so examined is taken as the type of many, and the stand of an acre or of a considerable territory is thus estimated.

In this process the assumption is made that trees of the same dimensions are approximately similar in shape, while for the individual tree the fundamental factors determining contents are recognized as *height* and *diameter*. These two factors in any kind of timber work cannot possibly be disregarded. Whatever the scaling or mill practice of a locality may be, and into whatever form a tree's trunk is dissected before manufacture, the height of the tree and its diameter at some point near the base are the chief factors determining contents. These factors, consciously or unconsciously, are in the mind of every estimator.

Scientific study of tree form began by making the same assumption and selecting the same factors. While it

was known that single trees depart widely from the type, it was assumed that for trees having the same diameter and height an average volume could be ascertained which would hold approximately throughout the distribution of the species. Proceeding on this assumption, tables were worked out for the different tree species and these when applied in actual business proved close to the fact and vastly improved the work of timber valuation in Germany a hundred years ago.

European measurements of logs and standing timber do not recognize anything corresponding to the board foot, but everything is reckoned in solid contents. The same rule holds in the scientific study of tree form in all countries where it has been pursued, the unit in the United States being the cubic foot. For all such studies, too, the **total height** of the tree as a well-defined factor capable of ready measurement has usually been employed rather than any size limit set part way up, and a **diameter breast high**, or  $4\frac{1}{2}$  feet above the ground, has been settled upon as the basis of all diameter comparisons. The area of a cross-section of a tree at this point is called the **basal area**, and the same term is applied to a number of trees or to a stand of timber. In the study of tree form, the term **form factor** has proved to be a useful one. The form factor of a tree is the percentage which the volume of any tree (usually reckoned in cubic feet, outside the bark) makes of the volume of a cylinder having the same height and the tree's breast diameter. *Illustration:* A tree 15 inches in breast diameter and 75 feet high may, after caliper measurement every 4 feet along it, prove to have 38.6 cubic feet in it. A cylinder of these dimensions contains 92 cubic feet. The form factor, therefore, is .42.

For many years past the study of tree form has been ardently pursued, and many interesting facts and laws have been ascertained. In large measure these results have been brought to bear on the actual business of European countries where timber is grown as a crop under uniform conditions. In this country, where the forests are natural and as a rule irregular, it will be many years before the same can be true. The following, however,

may for one reason or another be of interest to the worker in timber:

(a) Near the ground a section taken lengthwise of a tree is concave outward, due to the swell of the roots. Above that, to a point somewhere near the lower limbs of a forest-grown tree, the stem has almost a true taper. From the lower limbs up, the form is roughly conical, with a sharper taper than below, the taper usually increasing toward the top.

(b) Of two trees having the same breast diameter, the shorter will usually have the larger form factor. This results from the relation just mentioned. Of two trees having the same height, the stouter, more openly grown tree will usually have a little larger form factor than the other.

(c) Of two trees having the same dimensions, the older one, as a rule, has the larger form factor. The effect of other conditions of growth can seldom be clearly traced.

(d) Different soft wood species do not differ from one another so greatly but that a volume table made for one may for some purposes be used for others.

A large form factor in all these cases simply means that the given tree more nearly approaches the form of a cylinder, or, in other words, that it has a large amount of wood for its height and diameter. That carries with it more scale, more sawed lumber, or more cord wood.

A table giving the contents of trees of stated dimensions is called a **Volume Table**. For scientific purposes solid content is given, standard measure, but a table may be worked out in cords, board feet, or any other unit required. The tables employed by European foresters at the present day are worked out commonly on the basis not only of height and diameter but of age classes or of some other determining factor, and they have proved to give the contents of standing timber very accurately.

Tables of this kind have also been frequently devised for estimating in this country. Usually these are local, worked out in the timber of the region in question according to local scaling methods; often also allowing the cull which is found to characterize the region. Such volume

tables have frequently been based on diameter alone. In other cases — and this is essential unless a region is very uniform in its timber growth — height has been taken into consideration as well.

Thus many western and southern cruisers have made up tables giving the contents of trees of each inch in diameter and yielding 2, 3, 4, etc., logs as these would be cut in local practice. Again, an old Adirondack manager made up a table showing the number of spruce required per cord of pulp wood for trees 7, 8, 9, etc., inches in diameter, and short, medium, or tall, as the case for his region might be. Local volume tables, thoroughly based and used correctly, are the most reliable kind.

**General Volume Tables** for business purposes are of two varieties, the trees being classified either by total height or by length of merchantable timber. The assumption on which the first is based, that trees which have the same diameter and total height do not, when taken in numbers, vary in form throughout the region of their distribution, may, with a caution on the matter of age,<sup>1</sup> be considered safe for most purposes. It is true, however, that some Pacific Coast timbers, with a very variable thickness of bark and the root swelling of large trees running above a man's height oftentimes, have to be handled with special caution.

The other variety of tables classifies trees in height by the number of standard log lengths they will yield or the height at which their boles attain a specified diameter. Under this plan the point to be observed is brought nearer the estimator. It is not, however, as sharply defined a point as in the other case, while, as explained on pages 274-275, special opportunities for error arise through variability in lumbering practice.

Another matter that has to be reckoned with in the valuation of standing timber, and which becomes in some species and regions a consideration of great importance, is defectiveness in quality. This no general volume table can allow for. It has to be worked out for each locality according to the judgment or experience of the estimator.

<sup>1</sup> See pages 161, 262, and 277.

Thirdly, a general volume table given in units of merchantable material assumes certain standards of lumbering practice. In one region, or on a property carefully handled, stumps may be sawed close to the ground, tops taken up to a small diameter, and every economy employed in cutting to advantage the material between; while in another region, or on another property, a large percentage of the wood of every tree cut down may be left to rot on the ground. Similarly in the mill there is great variety of practice, — location, equipment, market requirement, and men's capacity all having their effect here, as was explained and illustrated in earlier pages of this work. Then the question may not be at all of saw practice, but of the results of scaling, and here, as every lumberman knows, there is the widest diversity. The scale rules in actual use differ from one another in the values they give to the same log, in some cases by a ridiculous amount, while the practices that have grown up in their application are in some cases entirely artificial. Details need not be entered into here — a word to the wise is sufficient — but an example will bring the fact home. The Maine log rule, for instance, is believed by many to be the best commercial rule on the market, agreeing closely with the results of good saw practice; yet a Penobscot mill man once testified before a legislative committee that buying 26 million feet of logs by market scale for a season's stock, he sawed 30 million feet of long lumber out of it and slabbed heavily for a pulp mill besides.

Of the volume tables included in this work it may be said that their basis is clearly stated, including the number of trees involved, the standards of cutting and mill or scaling practice assumed, and the responsibility for the observations. They can, therefore, to a large extent be changed over to suit practice of another type. The tables original with this work, those for spruce and white pine, are based on figures taken from a large number of trees. These came from a wide range of country, and the computations show that no clear difference of form was introduced by the element of locality. Each tree was computed separately for its volume in the units desired (cubic feet,

board feet, or cords); the results have been averaged, evened by curves, and then the board-foot tables have been discounted by a small percentage to allow for normal defects of form and quality. Cutting practice that is economical, but not extreme, has been supposed throughout, the idea being to get, as nearly as possible, a conservative figure for good and economical practice.

In applying all these tables, considerable defects must be allowed for in the form of a discount. It is further to be clearly understood that they apply to timber as it runs and may be considerably off as applied to single trees.

In **volume tables for hard woods** merchantable length is in most cases preferable to total height as a factor because these trees characteristically spread out at the top, at once rendering total height hard to measure and destroying utility for lumber. Such tables also, because of greater irregularity of form and greater liability to defect in hard woods, are in general less trustworthy than soft wood tables. Several "graded volume tables," classifying the yield of trees by lumber grades, are in existence, but their utility apart from the local conditions in which they were constructed does not seem clear.

The way in which these volume tables may be tested and made to conform to the practices of any given locality is illustrated as follows:

A spruce property is to be explored on which cutting and scaling methods are as follows: — Timber runs up to about 20 inches in diameter and 75 feet in height; trees are cut down to the size of 12 inches on the stump or 11 breast high. Logs cut for saw lumber, one log from a tree, cut off where it will scale best. Logs are therefore seldom over 40 feet long and run from that down to 28 or 30. Scaling done with Maine log rule. If a log is 26 feet long or under, it is scaled as one log with the top diameter inside bark; if 27 to 30 feet, as two logs of equal length giving the butt log an inch larger diameter than the top; from 31 to 35 feet in the same way but allowing 2 inches "rise," and 3 inches on log lengths of 36 to 40 feet. In addition a level discount of 10 per cent is made on all logs to cover defects.

A half day's time spent following the logging crew and

examining trees as they are felled results as follows:— 20 normal trees 17 to 20 inches in breast diameter when scaled by the above methods give 4730 feet B. M., while trees of the same dimensions are given in the volume table on page 238 5720 feet. The actual scale, therefore, is 17 per cent less than the tabular values.

24 trees 14 to 16 inches in diameter which by the table should yield 4080 feet scale up 3480, or 15 per cent less.

30 trees 11 to 13 inches in diameter that by the table should yield 4380 feet, actually scale 3500, or 20 per cent less.

The figures of the volume table may now be reduced by these percentages in those heights and sizes where on the given job the figures are required. The working table will then be as follows:

Breast Diam. Inches	Feet in Height					
	50	55	60	65	70	75
11	52	56	64	72	84	92
12	60	68	80	88	96	108
13	72	80	92	100	112	125
14	85	100	110	125	140	155
15	100	115	130	145	160	175
16	..	130	143	155	175	190
17	..	142	158	175	190	210
18	..	155	175	195	210	230
19	..	175	195	215	240	265
20	..	195	220	245	270	295

## SECTION V

## PRACTICE OF TIMBER ESTIMATING

The methods that should be employed in a survey of standing timber depend on a great variety of facts of which the main ones are these: the size of the tract to be examined, the method and fineness of its subdivision, the variety in its stand of timber, the value of the timber, and the experience and qualifications of the estimator. These methods are best discussed in two divisions, — first, methods for small tracts with valuable timber as a rule; and second, those for large tracts where more extensive processes must be employed.

## A. SMALL TRACTS

1. In the case of very valuable timber it may pay the owner or purchaser to examine each tree individually, ascertain its contents carefully, and study it for defects. The net contents of each tree as so ascertained will then be put down separately in the notes, and in case several parties are interested, each tree may be stamped with a number to correspond with one in the notes. At any rate, blazing each tree examined is a good means to make sure that all are taken and to prevent measuring any twice.

Such procedure as this is appropriate to very large and valuable pine or to valuable but over-mature hard woods, which are especially liable to be defective. Volume tables might help in such cases, but they cannot be fully trusted; a scale rule at hand would be to many men of quite as much assistance. For instruments, a caliper would come in play along with an instrument to measure heights accurately, while use might be found for some form of the dendrometer. But the best part of the equipment of the estimator in such cases is local experience in cutting and sawing the same class of timber.

2. When timber in good stand and of considerable value is involved, it may be advisable to caliper each of the trees and measure a sufficient number to obtain the range of heights. After the stand is measured, sample trees of different sizes may be estimated after careful examination, or such trees may be felled and measured. Better than either of these methods, however, is a volume table giving the yield of trees of the given kind and dimensions. Volume tables, however, cannot be depended on to allow justly for defects. That is a matter for the judgment of the estimator.

The above method works well in woods of approximately even type. When, however, the stand has a great variety of form and quality, the difficulty in making a true valuation is greater. In that case it may be practicable to cut it up into nearly homogeneous parts.

The following example taken from practice will illustrate the methods of working in a simple case.

Estimate of about 7 acres of land, covered nearly throughout with white pine standing fairly evenly, but not as a rule very dense. Concluded after inspection that no such differences of type or

Field Observations			Computed Volumes		
Breast Diam.	No. Trees	Observed Heights	Deduced Height	Scale Each	Total Scale
8"	85	51-47-50-54-59	50'	50'	4250'
9	70	50-47-52-48-56-57	55	70	4900
10	70	69-55	60	95	6650
11	75	56-56-66-67-68	65	130	9750
12	78	72-75-69-80-69-63	69	162	12636
13	69	57-65-71-75-73	73	203	14007
14	66	77-75	76	245	16170
15	81	74-78-80-79-83	78	290	25490
16	71	74-80-85	80	335	23785
17	63	77-77-86-81	80	370	23310
18	63	77-83-86	80	405	25515
19	52	80-77	80	445	23140
20	47	75-82	80	485	21855
21	32	79-83-81	80	525	17800
22	12	76	80	570	6840
23	11	79-82-83	80	620	6820
24	6	77-86-77-82	80	665	3990
25	8	87	80	715	5720
26	3	.....	80	770	2310
Total					252938

Plot of Observed Heights and Deduced Height Curve

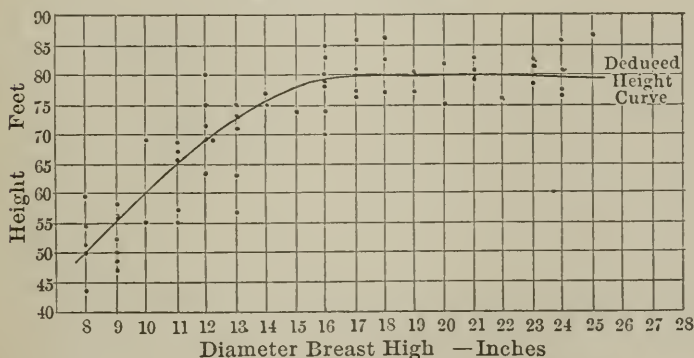

form existed as to call for differentiation of treatment. Instruments employed, caliper and Faustmann's hypsometer. Steps of the survey as follows:

a. Merchantable trees (those 8 inches and over in diameter breast high) calipered and scored in inch diameter classes.

b. Some 60 heights measured with the hypsometer. These might have been averaged for each diameter class, but a better plan is to plot all the heights on cross-section paper and draw a curve through them as in the accompanying sketch. From this curve the average height of the 8-inch trees is read off as 50 feet, of the 9-inch trees as 55 feet, and so on. The larger trees of the grove, those 16 inches and over in diameter, averaged 80 feet in height.

c. From the proper volume table the contents of a single tree of each size class is now taken and multiplied by the number of trees in the class. For the tract in question Table No. 4 gives the figures wanted, the product of the trees in boards, both round-edged and square-edged lumber. In this table the contents of a tree 8 inches in breast diameter and 50 feet high is given as 50 feet B. M.: that of a tree 9 inches x 55 feet, 70 feet, and so on. No discount appearing necessary for defects, by addition of the contents of the size classes the total stand of the lot is obtained. This comes to 253 M feet, of which in the practice of the locality 20 per cent may be sawed into good plank, 30 per cent into edged boards, and the balance of 50 per cent, the smaller trees and rougher logs, put into round-edged box-board lumber. The recorded figures, the plot and height curve, and a table showing the way the figures are put together, are given on the preceding page.

The estimate after this fashion of 250 M feet of timber of this size is a light day's work for two men. Three men form an economical crew for big jobs.

3. In the valuable timber lands of the Lake States and South it is customary to estimate each forty acres by itself, and the methods of estimation frequently cover the whole stand. Pacing is largely used as a measure of distance, and the cruiser is generally equipped with some kind of volume table giving as often as not the board contents of trees of different diameters yielding 2, 3, 4, or 5 16-ft. logs. Usually two men work together. In that case the helper may run a compass line across one end of the "forty," ten rods or so from its boundary, leaving marks enough so that on the return trip it can be followed. Through the strip so cut off the cruiser circulates, keeping watch of his other bound and scoring down, as he passes, the merchantable trees according to species and in appropriate classes. As a rule very little measurement of height or diameter has been done in the past. The two men keep abreast of one another. When one strip has been covered another is taken in the same way. After the whole "forty" has been covered addition of the

figures obtained gives its timber stand. In well-timbered land two to four "forties" a day can usually be covered by these methods.

In recording the results of such an estimate the size and quality of the timber are of course noted as well as its amount, and general notes on the growth, topography, and lumbering conditions of the land are also recorded. Following are sample notes of such an exploration:

Twp. 29 N. R. 7 W. S. E. $\frac{1}{4}$ of S. E. $\frac{1}{4}$ of Sec. 8.	
White Pine, 7 logs average to M.; 30% uppers	835,000
Norway Pine, 8 logs to M.	110,000
Hemlock, 11 logs to M.	175,000
Basswood, 7 logs to M.	15,000
Maple, 14 logs to M.	65,000
Total	<u>1,200,000</u>

Land slopes to North. Clay soil; very stony. Two ravines running N. W. and S. E. through the "forty." Tamarack swamp of about five acres in N. W. corner.

Another method of timber cruising carried out by one man alone is described as follows in the "Woodsmen's Handbook":

A "forty" is 80 rods square. The cruiser who uses the method now to be described has found by trial that 500 of his natural paces are required to go 80 rods.

He begins at the corner of a "forty," say at the southeast corner, and steps off 125 paces on the south line, and so covers one-quarter of the side. He then stops and, facing north, counts the trees of the "forty," first to an estimated distance of 125 paces on the right hand, and then to an estimated distance of 125 paces on the left hand, and in each case to a distance

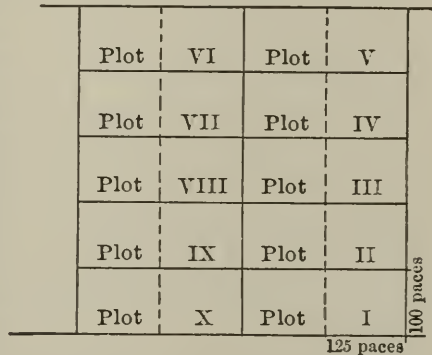

of 100 paces in front of him, thus including the area represented in the diagram as Plot I. He then steps north 100 paces, and in the same way counts the trees in Plot II, and repeats the operation successively for Plots III, IV, and V. He has then a complete count of the trees on the eastern half of the "forty." He then walks west 250 paces along the north line of the "forty." Facing south, he now counts all the trees on Plots VI, VII, VIII, IX, and X in the same way as before, and thus completes counting the trees on the entire "forty."

There is, of course, great variety in the details of the work as practiced by different men, and a plan that is really inadequate may be effective nevertheless because of the ability of the cruiser. Such a method as the foregoing cannot be called a survey. It is an estimate purely, depending on the training of the cruiser and subject to the errors which change in his condition and his surroundings introduce. Nor does the fact that all the area is supposed to be covered give assurance on the matter of accuracy. It may indeed set up a standard too difficult to be actually carried out, so becoming a source of additional error.

4. The following, from an old Michigan cruiser whose work has been largely in hard woods, serves to introduce the principle of covering a percentage of the tract to be estimated, a principle more fully illustrated in connection with large tracts on later pages.

I have been a surveyor, engineer, "land-looker" since boyhood, and the system that I use is based upon the information that I have been able to pick up along that line during that period. The work has carried me to the forests of nearly every state that counts forest products among its most important assets.

The usual object of an estimate is to fix a value that can be used as a medium of exchange, although I have recently been called upon to estimate many tracts just before the commencement of logging operations in order to ascertain what the probable product would be.

The report of the cruiser is required to show the log scale of a given tract, also the amount of tan bark, cord wood, telephone poles, railroad ties, etc., — in fact the entire forest product that is of value. This must be not only of standing timber, but of down timber that has a value as well.

His report must also show the topography of the tract, and the channels through which the product must be passed in the course of its transportation from the land, whether by railroad, water, or logging road.

This work must be based upon some system that will eliminate so far as is possible all guesswork. There are many systems of cruising now in use, each of which has its advocates. I do not know of any other cruiser who is using the same system that I use, perhaps for the reason that I have made it up from my own work.

In my work I use a tree caliper. I have a book printed especially for the tally of the trees as I call them off to my assistant. I have also a form of report blank made to fit the rest of the scheme.

You will note that I number each forty-acre parcel in an undivided section on the same plan that sections are numbered in a



Examination Lot...1-----

Sec....29-----

Made by-----

---May, 1908---

C. L.	Maple	Bass	Beech	Hemlock
12-1	/// 48			
12-2	/// 160			
13-1	/ 19			
13-2	// 64			
13-3	/// 180			
14-1	/// III 400	/	50 /// III	450 / 50
14-2	/// 440		/	110 / 110
14-3				
15-1	/// 216			/ 72
15-2	/// III / 1320		///	300 // 240
15-3				
16-1				
16-2	/// / 864		///	576 /// 432
16-3	/// III 2520	/	180 ///	540
16-4				

As soon as the assistant reports that he is ready I take the nearest tree and put the calipers upon it at a point where it would be cut in ordinary logging operations. I then walk around the tree and "size it up" generally to find any defect that may exist, also to judge how many 16-ft. logs would be cut from this particular tree. Suppose it is a maple and that it calipers 22 inches, and that it will yield a 48-ft. stem or three 16-ft. logs. I call to my pacer "Maple, 22—3," and he tallies in the maple column opposite the 22—3 of the figures in the left-hand margin of the page. In this way we get a record of every tree in a strip 4 rods wide, 2 rods each side of our compass line. My caliper blade is graduated to 57 inches from the stationary arm, just  $\frac{1}{2}$ th of two rods, and if there is any question as to a tree's being in the strip it is very quickly settled by taking seven lengths of the caliper blade as I walk toward the tree from the compass line.

Having taken the trees to a point a little in advance of my assistant, he proceeds on for 50 paces more and the calipering process is repeated. If the undergrowth is of sufficient density to prevent our seeing any large pine, bit of cedar swamp, or anything else that we should see, we make frequent explorations from the end of each 100 steps, my assistant going in one direction at the same time that I go in the opposite. No trees are measured in these side explorations unless we find something that is not common to the entire tract. Having returned to our line we proceed north, halting at each 50 steps to take the timber, also to note any ridges, logging roads, streams, springs, or other points that should appear in the report. When we have arrived at 500 paces my assistant changes his tally to lot 9 and we proceed north in the same way, changing at 1000 paces to lot 8 and at 1500 to lot 1. At 2000 paces, if the section is "full" we should be at the north line of the section, at a point 20 rods west of the northeast corner. As it rarely occurs that our compass line has been so accurate as to bring us out at exactly this point, we find the mark made during

our circuit of the section and pace from it westerly along the north line of the section for 250 paces, 40 rods. This brings us to a point from which a line drawn south will be parallel with the center line of lots 1, 8, 9, and 16, and with the west line of these lots and 20 rods distant from them. We proceed south on this line, taking the timber in the same manner as we took it in going north in the east half of the same lots. Arriving at the south side of the section we again go west 250 steps and then north through the easterly half of lots 15, 10, 7, and 2, and so on until the section is completed. A single "forty" or "eighty" or any sized tract is handled in the same way. This gives a caliper measure of every tree on 4 acres of each lot or on  $\frac{1}{15}$ th of its area. Should a closer estimate be necessary the strips are taken every 10 rods instead of 20 rods, which gives  $\frac{1}{3}$ th of each lot. If there are places in the tract from which owing to any cause the timber has been removed, the area must be shown on the report and proper deductions made from the estimate. If these vacant areas are crossed by the strips, care must be taken that they are not crossed lengthwise, as that would lessen the estimate too much; on the other hand, if they are crossed properly no deduction need be made from the tally.

When the calipering of the trees on the tract is completed the contents of the trees tallied are taken from the volume table, the scales footed, and the several footings multiplied by 10 or 5 according to the number of the strips taken.

My volume table is of my own making. During the last twenty years I have been called upon very frequently to measure trespass until measures have been taken of thousands of trees of each diameter. This work has been done in every section of the State in which hard wood has been cut during that period, and has been added to at every opportunity that has offered. The stumps were calipered by taking the measure both outside and inside the bark; the length of the stem was taken, together with the diameter of the top, inside the bark. On this basis the log scale was made according to the Doyle rule. The scale of trees of the same diameter and even of the same stump diameter and length vary considerably on account of the different tapers toward the tops, making it necessary to get a large number of trees from which to work up a table. The average of the total scale of all the trees of a certain diameter has been taken as the amount of scale to be allowed for all trees of a certain stump diameter and height.

The results of the work as I have stated have been very satisfactory. Many of the tracts have been cut the same season that we made the estimate, and the log scale is usually from 10 per cent to 20 per cent above my estimate. I should not care to get much nearer than this. It would not be safe, as some firms cut the timber much more closely than others, depending upon the article to be made from the timber, the disposal of the waste product for fuel, and so on.

No accurate estimate can be made without the use of the caliper. It entirely eliminates all favoritism on account of ownership



in small bodies of timber and in tracts of small dimensions. This is because a man can really see and grasp them. Such estimates are particularly useful for timber of small value or in very bunchy and irregular woods, which it is hard to survey. In such circumstances the judgment of a good woodsman is sometimes the best valuation that is practicable.

The ability to estimate timber after this fashion is gained by practice, and is based on personal experience and capacity; consequently each man goes about it in a way of his own. To know the area of the tract in question is generally of great assistance, and most men will be continually studying the matter of average stand per acre. As a preliminary step in arriving at this it is generally desirable to settle maximum and minimum stand as well.

For the contents of single trees a woodsman may rely on a mere glance, or he may figure carefully. A northern Maine lumberman, for instance, looking at a fair-sized spruce might estimate that it will cut a log 10 inches in diameter at the top and 30 feet long, and such a log he might know will measure 180 feet in local scaling practice. Again, in regions where logs are cut short, and several are taken from a good-sized tree, men frequently jot down the estimated contents of the several logs and add up the figures to get the tree's total contents. Using such methods to get at the size of the trees, lumbermen then go on, in one way or another, to get the contents of bodies of timber or stand per acre.

Frequently, however, the impression gained is a direct one, of quantity on a whole tract or of constituent bunches. A man cannot tell just how such figures come into his mind, but they do arise there, dependent somehow on his experience, perhaps in laying out roads or chopping timber. Such training is effective, and when the judgment arising as a result of it has been actually tested and found sufficiently close and reliable for any given purpose, it would be folly not to use it. But every one knows that such judgments are fallible, as in the nature of the case they could not fail to be. Differences in size and height may escape a man if the stands traversed look generally alike; the atmosphere and the lay of the land both have an effect on

the appearance of timber; a man's condition also varies from day to day, affecting his judgment in this matter, as in every other.

The above is the faculty of the old lumberman. On the other hand, the forester who has studied the rate of growth and the yield of timber has, in area, soil quality, and density of stocking, factors which he can profitably use to help him in his estimate of quantity. A fully stocked acre of white pine on good soil in Massachusetts, for instance, will yield at forty to sixty years of age a thousand feet of lumber for each year it has been growing, — a standard which a man may use to check the judgment through a considerable range of conditions.

Ocular estimate has been spoken of as especially appropriate to small tracts of land, but as a matter of fact the methods and principles here stated are still employed to a large extent in the valuation of the largest tracts as well, and even for the purposes of sale and purchase. This is perhaps not as it should be, but it has at least partial justification in the fact that as business goes the amount of timber on a tract is not the only element in value; often it is not the largest, even, for in addition availability, safety, the suitability of a tract to given purposes, and the financial situation of the parties concerned must all be considered. Sometimes a tract by reason of its relation to a given investment or manufacturing enterprise really must be had, almost regardless of its timber resources; while, on the other hand, though rich in timber, another tract may be dear at a small price. Accurate estimates of the quantity of timber, therefore, may be a secondary matter.

When large tracts are estimated by the eye, it is commonly done on the basis of so much to the acre, either from the looks of the stand or by comparison with some similar tract already cut. Subdivisions, if they exist, might be estimated separately, and the estimated area of waste lands would then be thrown out of account. Some old lumbermen might also estimate by valleys, judging quantity from the density of the timber and the length of the roads necessary to operate it.

6. Recount of the work done on a tract of 89 acres

in Massachusetts, having considerable value and a varied stand of timber, will illustrate the different methods of timber estimation and the way of going to work in a particular case. This tract was mapped topographically. The methods employed for that purpose are described in Part II and a complete map of the tract is given on page 114. The steps contributing to the timber estimate are as follows:

*a.* Boundaries run out to get area; chainage marks left at frequent intervals.

*b.* Some 65 M feet of heavy and valuable pine timber calipered tree by tree; numerous heights measured; contents ascertained from volume table.

*c.* Three bodies of thick young pine circled by staff compass and pacing to get area. Average stand of each bunch ascertained by laying out quarter-acre sample plots representing 10 to 20 per cent of the area. Trees on these plots calipered; heights measured or estimated; contents taken from volume tables.

*d.* Ten acres of hard-wood swamp in north end estimated for cord wood by similar but quicker methods.

*e.* Balance of 60 acres of ground is covered with scattering pine and hemlock, chestnut fit either for box boards or railway ties, poplar, red oak, and other hard woods. Northerly 37 acres considerably better than the other 23. Ran strip surveys across the two parts representing 10 per cent of the area, running the strips across the ridges and the belts of timber. Calipered the trees into classes of pine, hemlock, chestnut, poplar, hard woods fit to saw, and cord wood; estimated saw contents from tables, such as were at hand, adjusted to the locality and practice, with due reference to heights; estimated cord wood from tables, experience, and judgment.

The field work involved in steps *b*, *c*, *d*, and *e* represented one day's work for four men. Result was the following:

ESTIMATE OF CLARK BROS'. PARKER LOT, WOODSTOCK,  
MASS.

White Pine (including 50 M good plank)	660 M
Hemlock	35 "
Chestnut	156 "
Poplar	63 "
Red oak, etc.	67 "
Total saw timber	<u>981</u> "
Also hard-wood fire wood, 600 cords.	

These methods are those of an estimator not in frequent dealings with timber of this class. The owner of the lot, a man of long experience and in constant practice, would have chained or paced out the pine areas, and estimated their stand per acre from experience. The scattering soft wood and the heavy bunch of pine he would have estimated in a lump sum. The main elements of value being then dealt with, he would probably rely on his judgment for the rest after looking carefully through it. With a helper, he would take as much time as was actually consumed, or more. This man, one of the most successful operators in Massachusetts, says that using these methods he can estimate pine lots within 5 to 10 per cent as a rule, but occasionally makes a blunder of 30 to 50 per cent.

Other successful men in the same region, a region where stumpage values are high and competition for merchantable lots very sharp, show great variety in their methods. One man calipers all the timber on a lot he expects to purchase, assuring himself about stand and value in that way, and in addition securing data which tell him what he can best put the trees into. Others use no instruments but, relying on experience and taking plenty of time to look around, make a lump estimate. That there is great difference in cost among all these methods is not certain. It is sure, however, that for most men that method is best which has in it less guess work than measuring. But the facts recounted illustrate the principle that there may be several good methods of doing a given piece of work, and that the choice may turn on the training and habits of the estimator.

## B. ESTIMATION OF LARGER TRACTS

When land areas, as is frequently the case in the United States, are of large size, and particularly if the stand upon them is small and the value low, only a percentage of the area can be covered by a timber survey, and the problem is to make that percentage as representative of the whole as possible. Amidst the great variety of methods employed, three main types of work may be distinguished.

## 1. TYPE AND PLOT SYSTEM

According to this method the land to be passed on is divided up into types of known area and approximately like stand, without, however, necessarily leaving marks on the ground. Through these subdivisions of his area the cruiser travels, studying the size, height, density, and condition of his timber, and forming as he goes an estimation of the average stand. This estimate he checks by a number of sample plots, run out with the tape, and examined with care. The plots are usually laid out either in square or circular form, though the strip system is perfectly applicable.

Very satisfactory results have been arrived at by this method where a considerable area in sample plots has been surveyed or where the estimator is a man of judgment and experience. But choosing a few sample plots to represent a tract is recognized as a very delicate matter. Beginners generally select too good a piece, and the man who is really competent to do it can usually make a close guess at the whole thing. As with all other methods of estimating, area should be known from surveys, and that in not too large units.

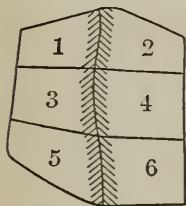

A good example of the application of this system comes from a national forest supervisor who had to estimate for a timber sale a tract of some 1200 acres. It lay in the form shown, with a ridge running down the middle of it, which naturally formed the first line of subdivision. The tract was

therefore surveyed with compass and chain and a dividing line run along the ridge top.

Then on each side of the ridge three distinct types of timber stand were recognized. The heaviest timber, red fir of good size, was in the middle; the north end was lighter, with a mixture of lodgepole pine; the south end had been damaged and rendered very thin by fire. These blocks were therefore blazed out and roughly surveyed. Thus the land was divided into six compartments of approximately even stand and of known area.

Then with a party of three men the supervisor ran 4-rod strip surveys <sup>1</sup> through each compartment, covering in each from 10 to 15 per cent of the area. Having no volume tables, he scored down instead the logs judged to be in the trees passed, in 16-ft lengths and by inch-diameter classes. In the office the contents of these logs were ascertained from the scale rule, multiplied by the number of each size, and added together. If then 10 per cent of a compartment had been covered, multiplying by 10 gave the stand of the compartment, which was the result desired.

With trustworthy volume tables and calipers better results could probably be had, but those here obtained were satisfactory. General good judgment is essential in carrying out such a survey, but, that given, a man can do it who has not had long woods and mill training. In fact, in the same forest one or two green but intelligent men are said to have been quickly trained so that their figures could be relied on within 10 or 15 per cent.

## 2. THE STRIP SYSTEM

The strip system of estimating has been used rather widely in woods work, not infrequently in connection with land subdivision. As a survey party is running through the woods, it is sometimes made the duty of the chainmen to count the merchantable trees for a stated distance on each side of the line run, the contents of the trees being determined oftenest by an estimate of the number necessary to make up a thousand feet. The same system in effect is sometimes used by the cruiser who counts the trees passed within a certain distance as he travels across a lot, or the work may be done more elaborately, and the caliper and hypsometer introduced to any extent thought advisable.

The methods of a Michigan cruiser who employs this system were described on page 178. Following are methods pursued on tracts of considerable size by a number of progressive concerns at the South dealing with pine and a variety of hard wood timbers.

The strip lines are usually  $\frac{1}{4}$  mile apart; they may be

<sup>1</sup> See next article.

carefully run and marked in advance by a survey party, or a compassman going along with the timber estimator may run and pace them. Topography may be mapped; notes are taken of swamp boundaries and other changes in the character of ground or timber.

The strip estimated is either one or two chains wide, split by the line of travel; thus either 5 or 10 per cent of the gross area is covered. The estimating party proper consists of three men, two to caliper the timber breast high, and one of good training who is responsible for the work as a whole and who does the recording and estimating. His note book has separate space for each species and under each a line for diameters by inch classes. Each tree on the strip is scored down as calipered, or it may be the number of 16-foot log lengths.

In such a vast region there is bound to be much variation in utilization, scaling, and mill practice so that when volume tables are employed they are usually of local origin to correspond. Since, however, the country is of very gentle topography, height and taper within the same species are unusually even. Two inches taper for each 16-foot log above the butt log has been found to be widely characteristic of pine timber, and three inches of hard wood timber. Some tables then have been made up on the basis of these regular tapers.

Small Diameter of Butt Log Inside Bark	Number of 16-foot logs					
	1	2	3	4	5	6
	Contents in Feet Board Measure					
15	160	280	360	410	440	...
16	180	320	420	480	520	540
17	200	360	480	560	610	640
18	230	410	550	650	710	750

Accompanying is an extract from a volume table<sup>1</sup> constructed on this plan, giving figures that, when manufac-

<sup>1</sup> From "Southern Timber Tables" by Howard R. Krinbill, Newbern, N. C. Copyrighted.

ture of highest present economy is practiced, approximate mill output. A peculiar feature will be noted in this table — that the base diameter employed is not diameter breast high, but diameter inside bark at the top of the first log length. A reduction from calipered diameters is required therefore, for bark thickness and for taper. This reduction is made either tree by tree in the field by estimate or in the office by classes on the basis of measures taken in logging operations. Timber quality is a matter of importance. It is seldom or never dealt with in the field other than by way of general comparison and experience.

The strip system was also largely employed in the early years of the United States Forest Service, with the object of ascertaining not merely the merchantable timber on the tracts examined but also the number and kind of young trees growing there as a basis for recommendations as to treatment. The method and cost of strip survey work as carried out by the Service men are indicated in the following extract from the "Woodsman's Handbook":

Sample acres are laid off in the form of strips, 10 surveyor's chains long and 1 chain wide, and the diameters of all trees to be included in the estimate are measured at breast height with calipers. At least three men are required to do effective work under this method. One man carries a note book, or tally sheet, and notes the species and their diameters as they are called out by the men who take the measurements. The tallyman carries the forward end of the chain, the other end of which is carried by one of the men taking the measurements. The chain is first stretched on the ground and the trees are calipered within an estimated distance of 33 feet (one half chain) on each side of the chain. When all trees adjacent to the chain have been calipered the whole crew moves on the length of another chain in the direction chosen (by the tallyman). The chain is again stretched on the ground and the trees are calipered on each side of it as before. This same operation is repeated until the trees have been measured on a strip 10 chains long. Notes are then made of the general character of the forest and the land, according to the requirements of the investigation. If heights are desired they may be taken by a separate crew, or as the calipering crew encounter from time to time trees whose heights are desired, they may stop long enough to take such measurements.

In an average virgin forest a crew of three men will caliper the trees on from 20 to 40 acres in one day if only trees of merchant-

able size are included, or from 15 to 25 acres if the small trees also are calipered. Small trees are measured principally in studying the question of future growth.

## FORM OF NOTES

Locality *T. 5. R. 18. W. E. L. S., Maine*

Type *Hardwood. Slope* Date *Sept. 17, 1901*

Sheet No. *A. 41*

D.B.H.	Spruce	Dead	Fir	White Birch	Beech	Hard Maple	Pine	Popl.
2 in.	☒ ☐		☒	:				
3 "	☒ :.		:.:					
4 "	☒ .		:.:	:				
5 "	☒ .		:.:					
6 "	:.:		:.:	☒ .:				:
7 "	[ ]		:.:	☒ .:	:			.
8 "			:.:	☒ .		:.:		:.:
9 "	:		:.:	☒ .:	.	:		☒ .:
10 "			:.:	.		.		
11 "	.		.	.		.		.

On large tracts satisfactory estimates can be made by the measurement of about 1 out of every 30 acres. In very extensive forest tracts the Bureau of Forestry usually measures not more than one or two out of every hundred acres.

This method is clearly adapted to securing knowledge of the make-up of a forest, and of its stand of merchantable timber if good volume tables are at hand to go with it. In the latter connection perhaps the greatest difficulty that arises is in applying the proper heights to the different diameters. This is slight if the tract is of small size and uniform character, but considerable on large tracts with uneven topography and varying stand. In addition constant care is required to make sure that the strip is kept of right width, in other words that all trees less than 2 rods from the line run are included and none at a greater distance. Careful men do indeed quickly get trained to

this so that their eyes are true, but with the best of men an occasional swing-off of the chain is necessary. Defects in timber also remain to be allowed for.

As applied to large tracts the strip system may either be employed within types the boundaries of which have been ascertained, as was explained in the last article, or it may be laid out in long lines across country and itself be used to define those boundaries and to get the topography. A number of townships in Maine have been surveyed in the following manner:

a. Township lines re-run and re-blazed; chainage marks left every half mile.

b. A center line run through the township, this also being chained and marks left each half mile.

c. From a main camp on the center line, 4-man parties ran strip surveys from a mark on the center line out to the boundary, checked on the mark there, set over a half-mile, and ran back. This was 2 days' work, and the party consequently carried outfit required to stay out one night, the main camp meanwhile being moved along the center line. Note was kept of the ridges and streams crossed, also of the lay of the land, of the bounds of cuttings, and of marked types of timber. Elevations on such a survey may be got by barometer, and a topographic map made up as a result.

### 3. LINE AND PLOT SYSTEM

A third system employed with some variations in different parts of the country, most largely perhaps among spruce men in the East, combines features from both the foregoing. Under this system the cruiser while at work travels in straight lines through the country to be explored, using his eyes as well as may be while actually traveling, but stopping at regular intervals to count and estimate the trees on an area about him. The area usually chosen is a quarter acre, which has a radius of 59 feet, or, for most men, of 23 paces. For a check on this distance a tape line should always be carried in the pocket, and every morning, as well as occasionally through the day, the eye should be checked by actual measurements.

Carefully training in this way, a man will find himself able to guess within 2 feet of the 59.

The timber may be estimated according to any method deemed most satisfactory. It may be calipered by an assistant and the factor of height gone into to any extent thought best, but most men in the spruce region do that only as a check, while in common practice, after counting the trees of any species or class, they estimate their contents on the basis of so many to the cord or to the thousand. Occasional calipering and height measurement as a check on the eye are highly desirable, and volume tables also are a help in most cases. But some species of trees (as cedar and beech in many localities) are so imperfect and defective that volume tables, if they were in existence, could not be depended upon. Such timber has to be estimated out of hand, and lumbering experience, together with the figures of the scale rule carried either in a man's head or in his pocket, will prove the best equipment for it.

One advantage of this method is its cheapness — one man may do the work alone. Further, all doubtful points are settled on the ground, face to face with the timber — there is no discounting or computing afterwards more than to add up the results. Then the small size of the area and the nearness of the observer to the trees under consideration enable him, if he has proper experience and judgment, to set contents very close. Lastly it will be seen that the systematic travel followed gives, in a simple country, material for mapping its timber types, also its topography, as was explained in Part 2 of this volume.

Following are specimen notes of a line of estimate run directly across a section with quarter-acre counts taken 150 paces apart. The timber is scored in the following classes: (a) spruce above cutting limit of 14 inches stump diameter in board feet; (b) smaller spruce down to 6 inches breast diameter in cords; (c) fir in cords; (d) cedar in feet B. M.; (e) pine; (f) good hard-wood logs. Number and contents of trees both given.

This method of timber cruising may be employed on land areas of any size, and has been largely employed on areas of a mile square, or "sections."

To travel the boundaries of a square mile and twice across it, taking quarter acres each 20 rods as determined by pacing, gives about  $2\frac{1}{2}$  per cent of the area actually covered by the estimate, and that percentage can be relied upon to give, in land which has any regularity of type, a close approximation to the truth. To do that and what goes with it, section after section through a township, is just about a fair day's work.

<i>Sp. Logs</i>	<i>Sp. Pulp</i>	<i>Fir</i>	<i>Cedar</i>	<i>Pine</i>	<i>HardWood</i>	
4-400	3-.3	16-1½	12-300			
9-1200	28-4					
8-1800	2--	8-1				<i>Soft woods on flat</i>
3-400	7-1			1-100		<i>land, stony but</i>
3-500	7-1	34-4				<i>Smooth logging.</i>
10-2000	7-8	24-3	4-100			<i>Abundant reproduct-</i>
9-1300	2--	9-1.3				<i>ion of fir, with spruce</i>
8-1000	7-1	12-1½		2-300		<i>&amp; occasional pine in</i>
11-1500	23-2½	8-1				<i>openings.</i>
8-1000	37-3					
5-800	19-2	5-½	<i>Last 60 rods in</i>		2-300	
3-700	6-.6	4-.3	<i>mixed growth</i>		5-900	
<i>Per</i> <i>Acres 4200'</i>	5.4 C.	4.7 C	133'	133'		

The last two methods described as usually employed are alike in this, that in the endeavor to get at a fair sample of the country they depend mainly on mechanical arrangements rather than choice. This as a general rule is a safe thing to do. There will always be enough things left to exercise the best judgment of the estimator. On the other hand, neither this nor any other system should be followed blindly. If part of the tract is especially valuable, especial pains should be taken with it. As a rule it will be found safe to ascertain the area of such tracts and

estimate them separately, while on the other hand the area of bogs, burnt lands, barren mountain tops, etc., should be ascertained and thrown out of account.

### C. SUMMARY

The above described are well tried methods of timber estimating and survey, but what has been written affords hardly more than suggestions as to how any particular job may best be done. Each method has its merits which may strongly recommend it for some particular circumstances. Very much too depends on the training and qualifications of the man doing the work. Every man long in the business commonly has a line of work in which he becomes proficient, developing methods best suited to himself to which in ordinary cases he will adhere. In conclusion, the following guiding principles may be laid down:

1. Estimates by lump sum are not usually reliable or at the present day sufficient.

2. Estimates of so much to the acre are much easier to make and more likely to be close to the fact.

3. In any kind of timber estimate or survey, the area of the land ought to be known, and that in units not too large. Within limits the smaller they are the better, all the more so if each unit contains but one timber type.

4. Every time a measurement is substituted for a guess or judgment, the more reliable will be the result. On the other hand, experience and good judgment never cease to be required in the business.

5. No estimate is worth much, practically speaking, which fails to take height into account as well as diameter.

6. Quality in some circumstances is quite as material to an adequate timber survey as quantity. Its determination is fully as difficult.

7. "The more defective the trees are, the more preferable is the cruiser's judgment and long local experience in the mill and in the woods to mere measuring."<sup>1</sup> The same is true where great differences in value are dependent upon quality or grade.

<sup>1</sup> Schenck's "Forest Mensuration."

8. Very bunchy timber can be estimated only in bunches or tree by tree. No general system of lines or plots can be trusted to give safe results.

9. In the emergencies which arise in actual business, a little rough and ready land surveying is often the most vital part of a reliable timber estimate. One or two lines run with compass and chain will frequently check areas of waste land or of different stand in effective fashion. Transit and stadia work on streams or roads often affords very material help. There is continual call for the sort of results that can best be obtained by means of compass and pacing.

#### D. PACIFIC COAST METHODS

Much Pacific Coast timber is 200 feet and over in height and of diameter to correspond, while the stand sometimes passes 20 million feet per quarter section. It is evident, therefore, that because of the values involved intensive methods of cruising are appropriate, while peculiarities of method are suggested by the very size and height of the timber. Of the region as a whole the portion west of the Cascade Mountains in Washington and Oregon, producing Douglas fir, "Oregon pine" as it was called formerly, is most active and characteristic, and the following refers to that region unless specified otherwise.

##### SUCCESSIVE LOGS IN A FIR

	Top Diam.	Scale	% of Total
1st 32-foot log . . . . .	31	1420	33
2nd 32-foot log . . . . .	28	1160	27
3rd 32-foot log . . . . .	25	920	21
4th 32-foot log . . . . .	20	560	14
5th 32-foot log . . . . .	14	230	5
Total . . . . .		4290	100

Adjustment of methods to the conditions is illustrated particularly by the volume tables employed, for those at present in most extensive and responsible use are

constructed on principles that have very seldom been employed elsewhere. After basal diameter, taper per 32-foot<sup>1</sup> log is the next factor allowed for, total height of the tree is disregarded, and number of logs is the third factor in the tabulation. This has reason behind it as well as experience. In timber of such dimensions total height is not readily estimated; the lower logs of the tree are very much the largest and far the best in quality; a log more or less in the top, comparatively small in size, full of large knots and liable to be broken up in felling, is of small account in the estimate anyway.

In connection with these tables, basal diameter also is handled in a peculiar manner. In some tree species thickness of bark is very variable, while the root swelling of large trees frequently reaches to the height of a man and higher. Diameter therefore is taken as nearly as may be where the tree takes on its regular form, considerably above breast height as a rule; deduction is made for any swelling not thus allowed for, and double the thickness of bark as actually found is then subtracted. By this means, the wood alone is dealt with, and basal diameter is aligned with the general shape of the tree.

In view of the facts above mentioned it is clear further how windfalls furnish the best obtainable assistance to the cruiser's judgment in respect to height and taper, also that the diameter tape and Biltmore stick possess advantages over the caliper. Then two additional problems arising out of the size of the trees confront the cruiser: first, breakage in felling is a much more important factor than elsewhere, and its amount varies widely with the ground conditions; second, the defect arising from decay and other sources, very hard to judge, to detect even, in timber of this height, has to be handled with extreme care — careful looking, the examination of windfalls, experience, perhaps the outturn of adjacent timber serving as a guide to it.

The "forty" is the ordinary unit of area for cruising and a timber report, and it is gridironed with straight line travel. Pacing serves ordinary purposes as a dis-

<sup>1</sup> Tables based on 16-foot logs are also in existence.

tance measure; a vernier compass is usually employed for the sake of more accurate line running. Twenty to fifty per cent of the gross area is commonly covered by actual estimate, one hundred per cent in some cases. The unit party for the work consists of two men, compassman and cruiser, of whom one handles distance, area, and topography, while the other is responsible for the timber. Details of practice vary much, as elsewhere, in accordance with the purpose of a cruise, conditions found, and the training of different estimators. Following is a description of a method as near standard as any, widely employed in work of high responsibility.

a. Section lines are usually freshened up and re-chained, and a center line may be run through each section. The main purpose of this work is to set stakes for the guidance of the cruising party. It is so laid out that the actual cruise or estimating lines will run as nearly as may be across the features of the topography.

b. The cruising party, starting at one corner of the section to be examined, proceeds to the nearest stake,  $2\frac{1}{2}$  chains from it, whence the compassman, with the declination set off in his staff compass, travels parallel to the side line of the section, keeping account of his pacing, taking aneroid readings at changes of the ground, and sketching topography. Behind him follows the cruiser, who for a width of 5 rods on each side, estimates the timber. 500 steps, 4 tallies, make a quarter mile, the width of a 40. At that point the scoring of timber begins anew, for the new forty being entered. So the work proceeds until the opposite section line is met (or at half that distance if the section is subdivided), when the pacing is checked up, the compass work tested on the stake and declination reset if necessary. Offset is then made to the second stake,  $7\frac{1}{2}$  chains from the corner, from which point a parallel line is run in the opposite direction. Four such lines are run across each tier of forties. With 16 such lines the cruise of the section is completed.

c. The detail of the estimating work is as follows:—First, in nearby timber being cut, or in ordinary circumstances by examination of windfalls, the cruiser trues up

his judgment on the contents of the trees. In this connection his volume table is of assistance since study of the height and taper of the down timber shows to what portion of his tables its form relates it. Two and three inches per 32 foot log are light tapers, not infrequent in hemlock and young fir, but four and five are usual in mature fir timber. This examination also tells something as to log quality and the amount of defect. Along with it the cruiser makes sure by numerous tests that his eye is true on basal diameter. With these points settled his preliminary work is done and, with an eye out for factors that influence breakage and particularly for "conks" and other signs of unsoundness, he will proceed confidently. The figures he sets down on his tablet represent his judgment of the merchantable contents of trees as he passes them, species, individual form, defect, and breakage all being allowed for. The conscientious man, however, applies frequent check by further examination of wind-falls and occasional measurement of strip width and of basal diameters.

## SAMPLE OF CRUISER'S FIELD NOTES

(Usually made on celluloid sheets)

Fir	Dead & Down	Cedar	D & D	Hem.	Spruce	Poles		
						Fir	Hem.	Cedar
2-6 M	2	1-.7	.S	1-1.5	1-5 M	1	1	111
1-2.5	1.5	1-.4	..	2-2.5	...			
6-30	..	1-3.	..	1-.3	...	Average 45' long		
2-7.5	..	...	..	1-1.	...	9' diam. at middle		

*d.* Checks from outside are a feature of the work as carried out on a large scale commercially. The different cruisers in a large party may be set to check one another as a corrective and for uniformity; a head cruiser periodically checks each man to catch up any slackness, correct any wrong tendencies, and give advice or directions.

Two miles of line per day are the standard product for this method of cruising, giving eight working days to

the section, which involves a cost of about 25 cents per acre outside of the checking, overhead and office work. Ordinary variations are:—

*a.* Double running each forty instead of running four times through it as above, a method widely practiced as costing less and considered sufficiently accurate in many circumstances. The cruise lines in this case are started 5, 15, 25, etc. chains from the section corner to divide the area equally. Sometimes, also, the strip is widened.

*b.* For preliminary work, one strip only may be run per quarter mile, and after a certain amount of that with its results in training, even this may be discontinued and a man rely on general observation.

*c.* A 100 per cent cruise is carried out in some cases. In this case a second compassman may advantageously be employed and the cruiser work between lines run and marked by the two men, the exact width of the strip being then of no consequence. Sometimes, also, a second estimator is employed to take care of certain classes of the timber.

*d.* Some men, instead of estimating the timber on strips, estimate circular areas so spaced along the compass line that they touch one another. For this practice it is claimed that a man can do better estimating work standing quietly at a center than while travelling, with his mind more or less distracted about footing, etc. In earlier times indeed a circular plot system was general, while another usual procedure was to count the trees on these circles or on strips to the length of one tally, and derive their contents from that of the average tree as estimated. Few follow this last practice at present, however.

In conclusion on this branch of the subject, the following, by a man of long experience and acknowledged competence in this line of work, is introduced for the light it throws on the broad aspects of the matter.

We work in general by the strip system but under a less hard-and-fast rule than formerly. More is left to the judgment of our cruisers as to the number of runs through a subdivision necessary to secure correct results. Thus, if we find one forty that

is densely timbered with a small uniform growth, we find that we secure better results by taking narrower strips, the equivalent of one sixteenth of a forty instead of one eighth. Where trees stand so thickly on the ground it is almost an impossibility for men to keep an accurate count on a wide strip as they can on one of half the width, and we find that the basis of much of the error that occurs in our work is due to inaccurate tree counting.

If the timber is large and particularly accurate results are desired, we now run 12 times through each forty and frequently work between blazed lines. That is, instead of running through the middle of the strip, the compassman sets over one-half its width and spots the trees on the opposite side from the cruiser to give the cruiser a line to work to on the return strip. This works very satisfactorily where the brush is not too dense.

Again, under certain conditions where we have a uniform stand of large timber, we run 4 times, taking strips equivalent to one-twelfth of a forty. This plan, we believe, gives better results than two strips each covering  $\frac{1}{3}$  of the whole.

These notes give some idea of how we attempt to carry on our work, but in the last analysis this cruising business resolves itself into one of personal capacity and attention upon the part of the cruiser rather than the method employed. A careful, conscientious and hard-working woodsman whom we can depend upon to go over the ground is more valuable than a more expert cruiser who takes much for granted. There was a time when I hoped to develop timber cruising to a point from which we could look upon our estimates as being absolutely reliable, but so long as there are influences that will work upon the minds of men, there will be variation and error. A man may do excellent work to-day and be totally unfit to be in the woods to-morrow, all for reasons which none of us can explain. A man must have confidence or he will be of little value. On the other hand I think I may safely say that the greatest element of uncertainty and error in men's work is their proneness to feel that familiarity has developed infallibility. The man who never develops absolute confidence in his eye and judgment and who checks himself up frequently, seldom goes far wrong.

There is, too, another side to this whole matter, one often neglected, but of great importance, and that we consider in our work as best we can. That is the standard of utilization of the timber. As a matter of fact there is surprising difference in the way timber is cut, though I could not define this as a percentage. A concern milling its own timber cuts closer than one selling its logs; and there is variation with the market itself. Then occa-

sionally a tract is cut with such carelessness that<sup>6</sup> the yield is very materially cut down. We have to meet the wishes of our customers if clearly expressed, but we protect ourselves by an explicit statement of the kind of utilization which our estimates imply, and by an exact showing of the basis on which the work was done.

**Timber Quality.** While the above applies specifically to the Douglas fir country, much the same methods are employed in the Interior and California, with resort to others of less intensiveness, similar to those in use elsewhere, when stands are lighter or less valuable. The preceding, however, is inadequate in one field of importance, in that *quality* of timber has been given scant emphasis. This throughout the region is no less important a factor in value than quantity. In fact, in very much territory timber has no commercial value unless its products are suitable for other than ordinary building purposes.

In the case of Douglas fir and timbers associated with it west of the Cascades this matter is simplified by the fact that log grades instead of lumber grades are made the usual basis of quality rating, the log grading rules in force in the market thus furnishing the standard to which the field man works. Since, however, both dimension and lumber quality enter into these, their application is not simple.

The grading rules for Douglas fir logs in force on Puget Sound follow; those of the other log markets are very similar. Spruce is commonly graded like fir. With cedar, because of the variety of products into which the wood may be manufactured, grading varies from time to time and locally. Hemlock logs and those of the species rarely met are sometimes classed in two log grades, those above 16" in diameter and surface clear, and all others.

*No. 1* (also called *Flooring*) logs shall be logs in the lengths of 16 to 32 feet and 30 inches in diameter inside the bark at the small end and logs 34 to 40 feet, 28 inches in diameter inside the bark at the small end, which in the judgment of the scaler contain at least 50 per cent of the scaled contents in lumber in the grades of *No. 2 Clear* and better.

*No. 2* (or *Merchantable*) logs shall be not less than 16 feet long and which, having defects which prevent their grading *No. 1*, in the judgment of the scaler, will be suitable for the manufacture of lumber principally in the grades of *Merchantable* and better. (*Merchantable* lumber must be free from knots or other defects in size or numbers such as to weaken the piece.)

*No. 3* (also called *No. 2*) logs shall be not less than 16 feet long which, having defects that prevent their being graded higher, are, in the judgment of the scaler, suitable for the manufacture of Common lumber.

*Cull logs* shall be any logs which in the judgment of the scaler will not cut  $33\frac{1}{3}$  per cent of sound timber.

An essential to reliable timber grading is experience, a background of knowledge of the out-turn of similar timber. In the next place, close examination of the stand is required as to the number and size of limbs and knots and for indications of these, or of other defects, that may lie beneath the surface. Age is a help here (these stands are commonly even-aged over considerable areas). Many cruisers go no farther than this and set percentage figures for log grades as the result of a broad judgment.

When further detail is thought desirable, the volume tables before mentioned are of assistance, giving as some of them do for a tree of given diameter, taper, and merchantable length the percentage each successive 32-foot log bears to total contents. One standard volume table contains the following directions:—

“Determine the percentages of the different grades as contained in a given percentage of the trees on each 40 acres by selecting, for instance, an average tree on each tally and carefully determining the percentage of the different grades of logs contained in these sample trees and applying the average to all trees on the forty.”

To illustrate, in the notes on page 199, 11 trees, 46 M feet, are scored down in the column of living fir, giving an average volume of 4200. 4 inches taper and 4 logs may fit this timber; if so, a tree yielding 4330 feet (see extract from taper table) gives a close approximation. Of such a tree a 32' butt log constitutes 37 per cent, the second log 28

per cent, and the third 21 per cent, while top diameters are approximately 33, 29 and 25 inches respectively. One of these logs is large enough for No. 1; it may or may not be clear enough. Second and third logs are of sufficient size, and likely to be of a quality, to put them in the second grade.

Methods in this branch of the work, however, vary greatly. A few, in the endeavor to reduce the field of judgment, have gone into much detail and devised forms of notes which record trees by sizes and log grades in each tree as its contents is estimated. Of the percentage of successive logs, it may be said that the above relations are fairly typical—that is to say in normal fir timber large enough so that log grades are of importance, about 35 per cent of the total contents of trees is contained in the butt log if cut 32 feet long, the second log will add 25 to 30 per cent more, and about 20 per cent will be in the third log. Breakage and defect may throw out these relations, and they are different in extremely tall or short timber.

Butt Diam. Inches	In. Taper in 32 Ft.	3 Logs or 96 Feet					4 Logs or 128 Feet					
		Diam. Top in.	Contents B. M	Logs			Diam. Top in.	Contents B. M	Logs			
				% 1st	% 2d	% 3d			% 1st	% 2d	% 3rd	% 4th
37	3	28	4230	40	33	27	25	5128	33	27	22	18
	4	25	3714	43	33	24	21	4330	37	28	21	14
	5	22	3234	46	33	21	17	3610	42	29	19	10
	6	19	2790	50	32	18	13	2979	47	30	17	06
	7	16	2386	55	32	11	..	.....	..	..	..	..
	8	13	2029	60	31	09	..	.....	..	..	..	..
	9	10	1729	66	28	06	..	.....	..	..	..	..

NOTE. Half logs are given in the original tables.

Since a large share of the timber of the fir region is realized on by its owners in the form not of lumber but of logs, the inducement is small to go further than the log in quality work in that region. It is otherwise, however, in the regions characterized by pine, where there are no

log markets and timber enters the commercial field in the shape of lumber with its great range in quality and value. Here the Forest Service, endeavoring in its own business to get away from the judgment of the individual applied in too broad a way, has started a line of inquiry that should in time prove serviceable to business. Log grades in this case again are made the basis to which the field man works, but mill and yard studies, carrying the product of those logs through the process of manufacture to point of sale, afford a means of going further, to an estimate of lumber quality and value. Definitions of the log grades that have been formed for yellow pine follow, and brief notes on the yield of those grades may be serviceable to some, although, with a small field covered, it has been found already that logs graded by the same man under the same rules vary considerably by locality in their yield of high grade lumber.

Yellow Pine Log Grades of the U. S. Forest Service.

*Clear logs* shall be 22 inches or over in diameter inside the bark at the small end and not less than 10 feet long. They shall be reasonably straight-grained, practically surface clear, and of a character which in the judgment of the scaler are capable of cutting not less than 25 per cent of their scaled contents into lumber of the grades of C Select and better.

*Shop logs* shall be 18 inches or over in diameter inside the bark at the small end, not less than 8 feet long, and which in the judgment of the scaler are capable of cutting not less than 30 per cent of their scaled contents into lumber of the grades of No. 2 Shop and better.

*Rough logs* shall be 6 inches or over in diameter inside the bark at the small end and not less than 8 feet long, having defects which in the judgment of the scaler prevent their classification into either of the two above grades.

Logs cut from rather large and high class timber at different points of interior Oregon, graded according to the above rules, have yielded as follows:

Clear logs 60-65 per cent No. 2 Shop and better, about half of it of grades B and C Select.

Shop logs 40-45 per cent No. 2 Shop and better, a fifth to a fourth B and C.

Rough logs have yielded about 15 per cent No. 2 Shop and better.

**For the Novice.** From the foregoing it will be inferred that the best timber cruising in the Pacific region is a highly expert business, requiring in addition to accuracy and alertness, thorough personal training and judgment in high degree. There are always learners in the field, however, and occasionally inexpert men are so situated that with whatever equipment they can command they must do their best to size up the quantity and value of timber. To such, a caution in respect to the loss of apparent volume that breakage, shake and decay may cause and the very large part that location, and especially quality, play in the value of timber is an essential service. Then it is true and worthy of regard that in these circumstances simple methods may actually give the best results.

A man may learn much in a logging operation where timber similar to that he is concerned with can be examined after it is felled and bucked into logs. He can see how much is broken up, whether the timber is rotten or sound, and from the cross cuts and surface indications of the logs examined at close range get an idea of the prevalence of knots, shakes and other blemishes. Then he can scale up the logs from a number of trees, ascertaining the total length utilized and the quantity of merchantable timber derived from each tree. This he will attach to its length and base diameter and endeavor to link up with trees of similar dimensions standing.

Such work as this will enable a man to understand a volume table, and he may even get enough measures to make one for himself in some size groups, with which he may check published volume tables. Or old devices and short cuts<sup>1</sup> may be tried out with the idea of sharpening

<sup>1</sup> Such as the following:—

Average the base diameter of the tree and the top diameter of its merchantable timber; get the scale of a log of that diameter

the observation and training the judgment. The best result that can come from such work (it can be gained only with time and experience, and some men never will acquire it) is the capacity to make a close estimate of the contents of a tree standing.

Contents of the average tree in a piece of timber, obtained by methods of this kind, may be made a starting point for the next step in the process. A man may count all the trees standing on a small piece of ground, using safeguards that he will readily think up to get all the trees in and not to count any a second time. If the territory is too large for that, sample acres in any number can be run out in fair average ground and the trees counted up on them.<sup>1</sup> A square acre is 209 feet on a side, about 80 paces. A circular acre is 236 feet in diameter. Or, some form of the strip method may be used as described on the preceding pages. The area of ground without timber should be thrown out; single trees or bunches that are of exceptional size and quality should be treated separately. Material loss from breakage enters when about 100 feet in merchantable length is passed, and runs up to nearly or quite 50 per cent on very broken land with heavy timber.

The above, compared with really adequate, professional cruising, is only an expedient; still, carried out by a clear-headed man, it might really be worth more than what passes oftentimes as something more ambitious. Such a man, too, can sometimes find out what he wants to know, or manage to protect his own interests in matters of this kind, without resort to timber cruising. Some men also have judgment on the contents of a body of timber as a whole who are unfamiliar with a systematic timber estimate, and would be slow and uncertain in the execution of it.

32 feet long; multiply by the number of 32-foot logs less one-half log.

Or, to base diameter add one-half of base diameter and divide by 2; multiply by .8, square and divide by 12. The result is the number of feet in the stick per foot of its length. 3 to 5 per cent may sometimes be added for contents above the point stated.

<sup>1</sup> For a caution on this head, see page 187.



PART V  
TABLES

SECTION I.	TABLES RELATING TO PARTS I AND II . .	210
SECTION II.	TABLES RELATING TO PARTS III AND IV .	235
SECTION III.	MISCELLANEOUS TABLES AND INFORMATION	293

## SECTION I

### TABLES RELATING TO PARTS I AND II

1.	STADIA REDUCTIONS . . . . .	211
2.	SOLUTION OF TRIANGLES . . . . .	212
3.	TRAVERSE TABLES . . . . .	214
4.	LOGARITHMS OF NUMBERS . . . . .	220
5.	LOGARITHMIC SINES, COSINES, TANGENTS, AND CO- TANGENTS . . . . .	222
6.	SUPPLEMENTARY TABLES OF SMALL ANGLES . . . . .	228
7.	NATURAL SINES AND COSINES . . . . .	230
8.	NATURAL TANGENTS AND COTANGENTS . . . . .	232
9.	SPECIMEN LETTERING . . . . .	234

STADIA REDUCTIONS

Horizontal Distance

	0'	10'	20'	30'	40'	50'		0'	10'	20'	30'	40'	50'
0°	100.0	100.0	100.0	100.0	100.0	100.0	16°	92.4	92.3	92.1	91.9	91.8	91.6
1°	100.0	100.0	99.9	99.9	99.9	99.9	17°	91.5	91.3	91.1	91.0	90.8	90.6
2°	99.9	99.8	99.8	99.8	99.8	99.8	18°	90.4	90.3	90.1	89.9	89.8	89.6
3°	99.7	99.7	99.7	99.6	99.6	99.6	19°	89.4	89.2	89.0	88.9	88.7	88.5
4°	99.5	99.5	99.4	99.4	99.3	99.3	20°	88.3	88.1	87.9	87.7	87.5	87.3
5°	99.2	99.2	99.1	99.1	99.0	99.0	21°	87.2	87.0	86.8	86.6	86.4	86.2
6°	98.9	98.9	98.8	98.7	98.6	98.6	22°	86.0	85.8	85.6	85.4	85.2	84.9
7°	98.5	98.4	98.4	98.3	98.2	98.1	23°	84.7	84.5	84.3	84.1	83.9	83.7
8°	98.1	98.0	97.9	97.8	97.7	97.6	24°	83.5	83.2	83.0	82.8	82.6	82.4
9°	97.5	97.5	97.4	97.3	97.2	97.1	25°	82.1	81.9	81.7	81.5	81.2	81.0
10°	97.0	96.9	96.8	96.7	96.6	96.5	26°	80.8	80.6	80.3	80.1	79.9	79.6
11°	96.4	96.3	96.1	96.0	95.9	95.8	27°	79.4	79.2	78.9	78.7	78.4	78.2
12°	95.7	95.6	95.4	95.3	95.2	95.1	28°	78.0	77.7	77.5	77.2	77.0	76.7
13°	94.9	94.8	94.7	94.5	94.4	94.3	29°	76.5	76.2	76.0	75.7	75.5	75.2
14°	94.2	94.0	93.9	93.7	93.6	93.4	30°	75.0	74.7	74.5	74.2	74.0	73.7
15°	93.3	93.2	93.0	92.9	92.7	92.6							

Difference of Elevation

							Proportional Parts								
	0'	10'	20'	30'	40'	50'	1'	2'	3'	4'	5'	6'	7'	8'	9'
0°	0.00	0.29	0.58	0.87	1.16	1.45	.03	.06	.09	.12	.14	.17	.20	.23	.26
1°	1.74	2.04	2.33	2.62	2.91	3.20	.03	.06	.09	.12	.14	.18	.20	.23	.26
2°	3.49	3.78	4.07	4.36	4.65	4.94	.03	.06	.09	.12	.14	.17	.20	.23	.26
3°	5.23	5.52	5.80	6.09	6.38	6.67	.03	.06	.09	.12	.14	.17	.20	.23	.26
4°	6.96	7.25	7.53	7.82	8.11	8.40	.03	.06	.09	.12	.14	.17	.20	.23	.26
5°	8.68	8.97	9.25	9.54	9.83	10.11	.03	.06	.08	.11	.14	.17	.20	.23	.25
6°	10.40	10.68	10.96	11.25	11.53	11.81	.03	.06	.08	.11	.14	.17	.20	.23	.25
7°	12.10	12.38	12.66	12.94	13.22	13.50	.03	.06	.08	.11	.14	.17	.20	.22	.25
8°	13.78	14.06	14.34	14.62	14.90	15.17	.03	.06	.08	.11	.14	.17	.19	.22	.25
9°	15.45	15.73	16.00	16.28	16.55	16.83	.03	.06	.08	.11	.14	.17	.19	.22	.25
10°	17.10	17.37	17.65	17.92	18.19	18.46	.03	.05	.08	.11	.14	.16	.19	.22	.24
11°	18.73	19.00	19.27	19.54	19.80	20.07	.03	.05	.08	.11	.13	.16	.19	.21	.24
12°	20.34	20.80	20.87	21.13	21.39	21.66	.03	.05	.08	.11	.13	.16	.18	.21	.24
13°	21.92	22.18	22.44	22.70	22.96	23.22	.03	.05	.08	.10	.13	.16	.18	.21	.23
14°	23.47	23.73	23.99	24.24	24.49	24.75	.03	.05	.08	.10	.13	.15	.18	.20	.23
15°	25.00	25.25	25.50	25.75	26.00	26.25	.03	.05	.07	.10	.13	.15	.17	.20	.23
16°	26.50	26.74	26.99	27.23	27.48	27.72	.02	.05	.07	.10	.12	.15	.17	.20	.22
17°	27.96	28.20	28.44	28.68	28.92	29.15	.02	.05	.07	.10	.12	.14	.17	.19	.21
18°	29.39	29.62	29.86	30.09	30.32	30.55	.02	.05	.07	.09	.12	.14	.16	.19	.21
19°	30.78	31.01	31.24	31.47	31.69	31.92	.02	.05	.07	.09	.11	.14	.16	.18	.21
20°	32.14	32.36	32.58	32.80	33.02	33.24	.02	.04	.07	.09	.11	.13	.15	.18	.20
21°	33.46	33.67	33.89	34.10	34.31	34.52	.02	.04	.06	.08	.11	.13	.15	.17	.19
22°	34.73	34.94	35.15	35.36	35.56	35.76	.02	.04	.06	.08	.10	.12	.14	.16	.19
23°	35.97	36.17	36.37	36.57	36.77	36.96	.02	.04	.06	.08	.10	.12	.14	.16	.18
24°	37.16	37.35	37.54	37.74	37.93	38.11	.02	.04	.06	.08	.09	.11	.13	.15	.17
25°	38.30	38.49	38.67	38.86	39.04	39.22	.02	.04	.06	.07	.09	.11	.13	.15	.17
26°	39.40	39.58	39.76	39.93	40.11	40.28	.02	.04	.05	.07	.09	.11	.12	.14	.16
27°	40.45	40.62	40.79	40.96	41.12	41.29	.02	.03	.05	.07	.08	.10	.12	.13	.15
28°	41.45	41.61	41.77	41.93	42.09	42.25	.02	.03	.05	.06	.08	.10	.11	.13	.14
29°	42.40	42.56	42.71	42.86	43.01	43.16	.02	.03	.05	.06	.08	.09	.11	.12	.14
30°	43.30	43.45	43.59	43.73	43.87	44.01	.01	.03	.04	.06	.07	.09	.10	.11	.13

SOLUTION OF TRIANGLES

The figure may refresh to good purpose the memory of the field worker. In it are graphically represented the functions (sine, cosine, secant, and tangent) of the angle  $BAC$ . The

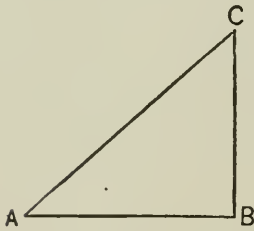

cosine, cosecant, and cotangent of  $BAC$  are respectively the sine, secant, and tangent of  $CAD$ , the complement of  $BAC$ .

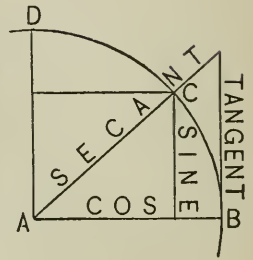

Represented as ratios, the functions of the angle  $A$  in the right-angled triangle  $ABC$  are as follows:

$$\text{Sine } A = \frac{CB}{AC}$$

$$\text{Cosine } A = \frac{AB}{AC}$$

$$\text{Tangent } A = \frac{BC}{AB}$$

$$\text{Secant } A = \frac{AC}{AB}$$

By these formulas, and the use of the tables of sines and tangents, all the parts of any right-angled triangle may be obtained if two sides, or an acute angle and a side, are given.

All the parts and the area of an oblique triangle may be obtained if any three parts including one side are given. Let  $A, B, C$  represent the angles, and  $a, b, c$  the opposite sides, of any oblique triangle; then the solutions are as given on the next page.

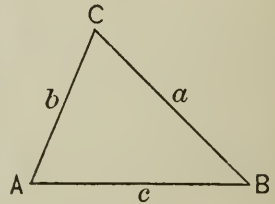

Given	Sought	
$A, B, a$	$C, b, c$	$C = 180^\circ - (A + B)$ $b = \frac{a}{\sin A} \sin B$ $c = \frac{a}{\sin A} \sin C$
$A, a, b$	$B, C, c$	$\sin B = \frac{b \sin A}{a}$ $C = 180^\circ - (A + B)$ $c = \frac{a \sin C}{\sin A}$
$A, B, C, a$	Area	$\text{Area} = \frac{a^2 \sin B \sin C}{2 \sin A}$
$C, a, b$	$\frac{1}{2}(A + B)$	$\frac{1}{2}(A + B) = 90^\circ - \frac{1}{2}C$
	$\frac{1}{2}(A - B)$	$\tan \frac{1}{2}(A - B) = \frac{a - b}{a + b} \tan \frac{1}{2}(A + B)$
	$A$	$A = \frac{1}{2}(A + B) + \frac{1}{2}(A - B)$
	$B$	$B = \frac{1}{2}(A + B) - \frac{1}{2}(A - B)$
	$c$	$c = (a + b) \frac{\cos \frac{1}{2}(A + B)}{\cos \frac{1}{2}(A - B)}$ $= (a - b) \frac{\sin \frac{1}{2}(A + B)}{\sin \frac{1}{2}(A - B)}$
	Area	$\text{Area} = \frac{1}{2} a b \sin C$
$a, b, c$	$A$	$\text{Let } s = \frac{1}{2}(a + b + c)$ $\text{Then } \sin \frac{1}{2}A = \sqrt{\frac{(s - b)(s - c)}{bc}}$ $\cos \frac{1}{2}A = \sqrt{\frac{s(s - a)}{bc}}$ $\tan \frac{1}{2}A = \sqrt{\frac{(s - b)(s - c)}{s(s - a)}}$
	$B, C$	Similar formulas
	Area	$\sqrt{s(s - a)(s - b)(s - c)}$

Course	Dist. 1		Dist. 2		Dist. 3		Dist. 4		Dist. 5		Course
	Lat.	Dep.	Lat.	Dep.	Lat.	Dep.	Lat.	Dep.	Lat.	Dep.	
0 15	1.0000	0.0044	2.0000	0.0087	3.0000	0.0131	4.0000	0.0175	5.0000	0.0218	89 45
30	0000	0087	1.9999	0175	2.9999	0262	3.9998	0347	4.9998	0436	30
45	0.9999	0131	9998	0262	9997	0393	9997	0524	9996	0654	15
1 0	9998	0175	9997	0349	9995	0524	9994	0698	9992	0873	89 0
15	9998	0218	9995	0436	9993	0654	9990	0873	9988	1091	45
30	9997	0262	9993	0524	9990	0785	9986	1047	9983	1309	30
45	9995	0305	9991	0611	9986	0916	9981	1222	9977	1527	15
2 0	9994	0349	9988	0698	9982	1047	9976	1396	9970	1745	88 0
15	9992	0393	9985	0785	9977	1178	9969	1570	9961	1963	45
30	9990	0436	9981	0872	9971	1309	9962	1745	9952	2181	30
45	0.9988	0.0480	1.9977	0.0960	2.9965	0.1439	3.9954	0.1919	4.9942	0.2399	15
3 0	9986	0523	9973	1047	9959	1570	9945	2093	9931	2617	87 0
15	9984	0567	9968	1134	9952	1701	9936	2268	9920	2835	45
30	9981	0610	9963	1221	9944	1831	9925	2442	9907	3052	30
45	9979	0654	9957	1308	9936	1962	9914	2616	9893	3270	15
4 0	9976	0698	9951	1395	9927	2093	9903	2790	9878	3488	86 0
15	9973	0741	9945	1482	9918	2223	9890	2964	9863	3705	45
30	9969	0785	9938	1569	9908	2354	9877	3138	9846	3923	30
45	9966	0828	9931	1656	9897	2484	9863	3312	9828	4140	15
5 0	9962	0872	9924	1743	9886	2615	9848	3486	9819	4358	85 0
15	0.9958	0.0915	1.9916	0.1830	2.9874	0.2745	3.9832	0.3660	4.9790	0.4575	45
30	9954	0958	9908	1917	9862	2875	9816	3834	9770	4792	30
45	9950	1002	9899	2004	9849	3006	9799	4008	9748	5009	15
6 0	9945	1045	9890	2091	9836	3136	9781	4181	9726	5226	84 0
15	9941	1089	9881	2177	9822	3266	9762	4355	9703	5443	45
30	9936	1132	9871	2264	9807	3396	9743	4528	9679	5660	30
45	9931	1175	9861	2351	9792	3526	9723	4701	9653	5877	15
7 0	9925	1219	9851	2437	9776	3656	9702	4875	9627	6013	83 0
15	9920	1262	9840	2524	9760	3786	9680	5048	9600	6390	45
30	9914	1305	9829	2611	9743	3916	9658	5221	9572	6526	30
45	0.9909	0.1349	1.9817	0.2697	2.9726	0.4046	3.9635	0.5394	4.9543	0.6743	15
8 0	9903	1392	9805	2783	9708	4175	9611	5561	9513	6959	82 0
15	9897	1435	9793	2870	9690	4305	9586	5740	9483	7175	45
30	9890	1478	9780	2956	9670	4434	9561	5912	9451	7390	30
45	9884	1521	9767	3042	9651	4564	9534	6085	9418	7606	15
9 0	9877	1564	9754	3129	9631	4693	9508	6256	9384	7822	81 0
15	9870	1607	9740	3215	9610	4822	9480	6430	9350	8037	45
30	9863	1650	9726	3301	9589	4951	9451	6602	9314	8252	30
45	9856	1693	9711	3387	9567	5080	9422	6774	9278	8467	15
10 0	9848	1736	9696	3473	9544	5209	9392	6946	9240	8682	80 0
15	0.9840	0.1779	1.9681	0.3559	2.9521	0.5338	3.9362	0.7118	4.9202	0.8897	45
30	9833	1822	9665	3645	9498	5467	9330	7289	9163	9112	30
45	9825	1865	9649	3730	9474	5596	9298	7461	9123	9326	15
11 0	9816	1908	9633	3816	9449	5724	9265	7632	9081	9540	79 0
15	9808	1951	9616	3902	9424	5853	9231	7804	9039	9755	45
30	9799	1994	9598	3987	9398	5981	9197	7975	8996	9968	30
45	9790	2036	9581	4073	9371	6109	9162	8146	8952	1.0182	15
12 0	9781	2079	9563	4158	9344	6237	9126	8316	8907	0396	78 0
15	9772	3122	9545	4244	9317	6365	9089	8487	8862	0609	45
30	9763	2164	9526	4329	9289	6493	9052	8658	8815	0822	30
45	0.9753	0.2207	1.9507	0.4414	2.9260	0.6621	3.9014	0.8828	4.8767	1.1035	15
13 0	9744	2250	9487	4499	9231	6749	8975	8998	8719	1248	77 0
15	9734	2292	9468	4584	9201	6876	8935	9168	8669	1460	45
30	9724	2334	9447	4669	9171	7003	8895	9338	8618	1672	30
45	9713	2377	9427	4754	9140	7131	8854	9507	8567	1884	15
14 0	9703	2419	9406	4838	9109	7258	8812	9677	8515	2096	76 0
15	9692	2462	9385	4923	9077	7385	8769	9846	8462	2308	45
30	9681	2504	9363	5008	9044	7511	8726	1.0015	8407	2519	30
45	9670	2546	9341	5092	9011	7638	8682	0184	8352	2730	15
15 0	9659	2588	9319	5176	8978	7765	8637	0353	8296	2941	75 0
	Dep.	Lat.	Dep.	Lat.	Dep.	Lat.	Dep.	Lat.	Dep.	Lat.	Course
	Dist. 1		Dist. 2		Dist. 3		Dist. 4		Dist. 5		

TRAVERSE TABLE

Course	Dist. 6		Dist. 7		Dist. 8		Dist. 9		Dist. 10		Course
	Lat.	Dep.	Lat.	Dep.	Lat.	Dep.	Lat.	Dep.	Lat.	Dep.	
0 15	5.9999	0.0262	6.9999	0.0305	7.9999	0.0349	8.9999	0.0393	9.9999	0.0436	89 45
30	9998	0524	9997	0611	9997	0698	9997	0785	9996	0873	30
45	9995	0785	9994	0916	9993	1047	9992	1178	9991	1309	15
1 0	9991	1047	9989	1222	9988	1396	9986	1571	9985	1745	89 0
15	9986	1309	9983	1527	9981	1745	9979	1963	9976	2181	45
30	9979	1571	9976	1832	9973	2094	9969	2356	9966	2618	30
45	9972	1832	9967	2138	9963	2443	9958	2748	9953	3054	15
2 0	9963	2094	9957	2443	9951	2792	9945	3141	9939	3490	88 0
15	9954	2356	9946	2748	9938	3141	9931	3533	9923	3926	45
30	9943	2617	9933	3053	9924	3490	9914	3926	9905	4362	30
45	5.9931	0.2879	6.9919	0.3358	7.9908	0.3838	8.9896	0.4318	9.9885	0.4798	15
3 0	9918	3140	9904	3664	9890	4187	9877	4710	9863	5234	87 0
15	9904	3402	9887	3968	9871	4535	9855	5102	9839	5669	45
30	9888	3663	9869	4273	9851	4884	9832	5494	9813	6105	30
45	9872	3924	9850	4578	9829	5232	9807	5886	9786	6540	15
4 0	9854	4185	9829	4883	9805	5581	9781	6278	9756	6976	86 0
15	9835	4447	9808	5188	9780	5929	9753	6670	9725	7411	45
30	9815	4708	9784	5492	9753	6277	9723	7061	9692	7846	30
45	9794	4968	9760	5797	9725	6625	9691	7453	9657	8281	15
5 0	9772	5229	9734	6101	9696	6972	9658	7844	9619	8716	85 0
15	5.9748	0.5490	6.9706	0.6405	7.9664	0.7320	8.9622	0.8235	9.9580	0.9150	45
30	9724	5751	9678	6709	9632	7668	9586	8626	9540	9585	30
45	9698	6011	9648	7013	9597	8015	9547	9017	9497	1.0019	15
6 0	9671	6272	9617	7317	9562	8362	9507	9408	9452	0.453	84 0
15	9643	6532	9584	7621	9525	8709	9465	9798	9406	0.887	45
30	9614	6792	9550	7924	9486	9056	9421	1.0188	9357	1.320	30
45	9584	7052	9515	8228	9445	9403	9378	0.578	9307	1.754	15
7 0	9553	7312	9478	8531	9404	9750	9329	0.968	9255	2.187	83 0
15	9520	7572	9440	8834	9360	1.0096	9280	1.358	9200	2.620	45
30	9487	7832	9401	9137	9316	0.442	9230	1.747	9144	3.053	30
45	5.9452	0.8091	6.9361	0.9440	7.9269	1.0788	8.9178	1.2137	9.9087	1.3485	15
8 0	9416	8350	9319	9742	9221	1134	9124	2526	9027	3917	82 0
15	9379	8610	9276	1.0044	9172	1479	9069	2914	8965	4349	45
30	9341	8869	9231	0.347	9121	1825	9011	3303	8902	4781	30
45	9302	9127	9185	0.649	9069	2170	8953	3691	8836	5212	15
9 0	9261	9386	9138	0.950	9015	2515	8892	4079	8769	5643	81 0
15	9220	9645	9090	1.252	8960	2859	8830	4467	8700	6074	45
30	9177	9903	9040	1.553	8903	3204	8766	4854	8629	6505	30
45	9133	1.0161	8989	1.854	8844	3548	8700	5241	8556	6935	15
10 0	9088	0.419	8937	2.155	8785	3892	8633	5628	8481	7365	80 0
15	5.9042	1.0677	6.8883	1.2456	7.8723	1.4235	8.8564	1.6015	9.8404	1.7794	45
30	8995	0.934	8728	2.756	8660	4579	8493	6401	8325	8224	30
45	8947	1.191	8772	3.057	8596	4922	8421	6787	8245	8652	15
11 0	8898	1.449	8714	3.357	8530	5265	8346	7173	8163	9081	79 0
15	8847	1.705	8655	3.656	8463	5607	8271	7558	8079	9509	45
30	8795	1.962	8595	3.956	8394	5949	8193	7943	7992	9937	30
45	8743	2.219	8533	4.255	8324	6291	8114	8328	7905	2.0364	15
12 0	8689	2.475	8470	4.554	8252	6633	8033	8712	7815	0.791	78 0
15	8634	2.731	8406	4.852	8178	6974	7951	9096	7723	1.218	45
30	8578	2.986	8341	5.151	8104	7315	7867	9480	7630	1.644	30
45	5.8521	1.3242	6.8274	1.5449	7.8027	1.7656	8.7781	1.9863	9.7534	2.2070	15
13 0	8462	3.497	8206	5.747	7950	7996	7693	2.0246	7437	2.495	77 0
15	8403	3.752	8137	6.044	7870	8336	7604	0.628	7338	2.920	45
30	8342	4.007	8066	6.341	7790	8676	7513	1.010	7237	3.345	30
45	8281	4.261	7994	6.638	7707	9015	7421	1.392	7134	3.769	15
14 0	8218	4.515	7921	6.935	7624	9354	7327	1.773	7030	4.192	76 0
15	8154	4.739	7846	7.231	7538	9692	7231	2.154	6923	4.615	45
30	8089	5.023	7770	7.527	7452	2.0030	7133	2.534	6815	5.038	30
45	8023	5.276	7693	7.822	7364	0.368	7034	2.914	6705	5.460	15
15 0	7956	5.529	7615	8.117	7274	0.706	6933	3.294	6593	5.882	75 0
	Dep.	Lat.	Dep.	Lat.	Dep.	Lat.	Dep.	Lat.	Dep.	Lat.	Course
	Dist. 6		Dist. 7		Dist. 8		Dist. 9		Dist. 10		

Course	Dist. 1		Dist. 2		Dist. 3		Dist. 4		Dist. 5		Course
	Lat.	Dep.	Lat.	Dep.	Lat.	Dep.	Lat.	Dep.	Lat.	Dep.	
15 15	0.9648	0.2630	1.9296	0.5261	2.8944	0.7891	3.8591	1.0521	4.8239	1.3152	74 45
30	9636	2672	9273	5345	8909	8017	8545	0690	8182	3362	30
45	9625	2714	9249	5429	8874	8143	8498	0858	8123	3572	15
16 0	9613	2756	9225	5513	8838	8269	8450	1025	8063	3782	74 0
15	9600	2798	9201	5597	8801	8395	8402	1193	8002	3991	45
30	9588	2840	9176	5680	8765	8520	8353	1361	7941	4201	30
45	9576	2882	9151	5764	8727	8646	8303	1528	7879	4410	15
17 0	9563	2924	9126	5847	8689	8771	8252	1695	7815	4619	73 0
15	9550	2965	9100	5931	8651	8896	8201	1862	7751	4827	45
30	9537	3007	9074	6014	8612	9021	8149	2028	7686	5035	30
45	0.9524	0.3049	1.9048	0.6097	2.8572	0.9146	3.8096	1.2195	4.7620	1.5243	15
18 0	9511	3090	9021	6180	8532	9271	8042	2361	7553	5451	72 0
15	9497	3132	8994	6263	8491	9395	7988	2527	7485	5678	45
30	9483	3173	8966	6346	8450	9519	7933	2692	7416	5865	30
45	9469	3214	8939	6429	8408	9643	7877	2858	7347	6072	15
19 0	9455	3256	8910	6511	8366	9767	7821	3023	7276	6278	71 0
15	9441	3297	8882	6594	8323	9891	7764	3188	7204	6485	45
30	9426	3333	8853	6676	8279	1.0014	7706	3352	7132	6690	30
45	9412	3379	8824	6758	8235	0.138	7647	3517	7059	6896	15
20 0	9397	3420	8794	6840	8191	0.261	7588	3681	6985	7101	70 0
15	0.9382	0.3461	1.8764	0.6922	2.8146	1.0384	3.7528	1.3845	4.6910	1.7306	45
30	9367	3502	8733	7004	8100	0506	7467	4008	6834	7510	30
45	9351	3543	8703	7086	8054	0629	7405	4172	6757	7715	15
21 0	9336	3584	8672	7167	8007	0751	7343	4335	6679	7918	69 0
15	9320	3624	8640	7249	7960	0873	7280	4498	6600	8122	45
30	9304	3665	8608	7330	7913	0995	7217	4660	6521	8325	30
45	9288	3706	8576	7411	7864	1117	7152	4822	6440	8528	15
22 0	9272	3746	8544	7492	7816	1238	7087	4984	6359	8730	68 0
15	9255	3786	8511	7573	7766	1359	7022	5146	6277	8932	45
30	9239	3827	8478	7654	7726	1481	6955	5307	6194	9134	30
45	0.9222	0.3867	1.8444	0.7734	2.7666	1.1601	3.6888	1.5468	4.6110	1.9336	15
23 0	9205	3907	8410	7815	7615	1722	6820	5629	6025	9537	67 0
15	9188	3947	8376	7895	7564	1842	6752	5790	5940	9737	45
30	9171	3987	8341	7975	7512	1962	6682	5950	5853	9937	30
45	9153	4027	8306	8055	7459	2082	6612	6110	5766	2.0137	15
24 0	9135	4067	8271	8135	7406	2202	6542	6569	5677	0337	66 0
15	9118	4107	8235	8214	7353	2322	6470	6429	5588	0536	45
30	9100	4147	8199	8294	7299	2441	6398	6588	5498	0735	30
45	9081	4187	8163	8373	7214	2560	6326	6746	5407	0933	15
25 0	9063	4226	8126	8452	7189	2679	6252	6905	5315	1131	65 0
15	0.9045	0.4266	1.8089	0.8531	2.7034	1.2797	3.6178	1.7063	4.5223	2.1328	45
30	9026	4305	8052	8610	7078	2915	6103	7220	5129	1526	30
45	9007	4344	8014	8689	7021	3033	6028	7378	5035	1722	5
26 0	8988	4384	7976	8767	6964	3151	5952	7535	4940	1919	64 0
15	8969	4423	7937	8846	6906	3269	5875	7692	4844	2114	45
30	8949	4462	7899	8924	6848	3386	5797	7848	4747	2310	30
45	8930	4501	7860	9002	6789	3503	5719	8004	4649	2505	15
27 0	8910	4540	7820	9080	6730	3620	5640	8160	4550	2700	63 0
15	8890	4579	7780	9157	6671	3736	5561	8315	4451	2894	45
30	8870	4617	7740	9235	6610	3852	5480	8470	4351	3087	30
45	0.8850	0.4656	1.7700	0.9312	2.6550	1.3968	3.5400	1.8625	4.4249	2.3281	15
28 0	8889	4695	7659	9389	6488	4084	5318	8779	4147	3474	62 0
15	8809	4733	7618	9466	6427	4200	5236	8933	4045	3666	45
30	8788	4772	7576	9543	6365	4315	5153	9086	3941	3858	30
45	8767	4810	7535	9620	6302	4430	5069	9240	3836	4049	15
29 0	8746	4848	7492	9696	6239	4544	4985	9392	3731	4240	61 0
15	8725	4886	7450	9772	6175	4659	4900	9545	3625	4431	45
30	8704	4924	7407	9848	6111	4773	4814	9697	3518	4621	30
45	8682	4962	7364	9924	6046	4886	4728	9849	3410	4811	15
30 0	8660	5000	7321	1.0000	5981	5000	4641	2.0000	3301	5000	60 0
	Dep.	Lat.	Dep.	Lat.	Dep.	Lat.	Dep.	Lat.	Dep.	Lat.	
	Dist. 1		Dist. 2		Dist. 3		Dist. 4		Dist. 5		Course

TRAVERSE TABLE

Course	Dist. 6		Dist. 7		Dist. 8		Dist. 9		Dist. 10		Course
	Lat.	Dep.	Lat.	Dep.	Lat.	Dep.	Lat.	Dep.	Lat.	Dep.	
15	5.7887	1.5782	6.7335	1.8412	7.7183	2.1042	8.6831	2.3673	9.6479	2.6303	74 45
30	7818	6034	7454	8707	7090	1379	6727	4051	6363	6724	30
45	7747	6286	7372	9001	6996	1715	6621	4430	6246	7144	15
16	7676	6538	7288	9295	6901	2051	6514	4807	6126	7564	74 0
15	7603	6790	7203	9588	6804	2386	6404	5185	6005	7983	45
30	7529	7041	7117	9881	6706	2721	6294	5561	5882	8402	30
45	7454	7292	7030	2.0174	6606	3056	6181	5938	5757	8820	15
17	7378	7542	6941	0466	6504	3390	6067	6313	5630	9237	73 0
15	7301	7792	6851	0758	6402	3723	5952	6689	5502	9654	45
30	7223	8040	6760	1049	6297	4056	5835	7064	5372	3.0071	30
45	5.7144	1.8292	6.6668	2.1341	7.6192	2.4389	8.5716	2.7438	9.5240	3.0486	15
18	7063	8541	6574	1631	6085	4721	5595	7812	5106	0902	72 0
15	6982	8790	6479	1921	5976	5053	5473	8185	4970	1316	45
30	6899	9038	6383	2211	5866	5384	5349	8557	4832	1730	30
45	6816	9386	6285	2501	5754	5715	5224	8930	4693	2144	15
19	6731	9534	6186	2790	5641	6045	5097	9301	4552	2557	71 0
15	6645	9781	6086	3078	5527	6375	4968	9672	4409	2969	45
30	6658	2.0028	5985	3366	5411	6705	4838	3.0043	4264	3381	30
45	6471	0275	5882	3654	5294	7033	4706	0413	4118	3792	15
20	6382	0521	5778	3941	5175	7362	4562	0782	3969	4202	70 0
15	5.6291	2.0767	6.5673	2.4228	7.5655	2.7689	8.4437	3.1151	9.3819	3.4612	45
30	6200	1012	5565	4515	4934	8017	4300	1519	3767	5021	30
45	6108	1257	5459	4800	4811	8343	4162	1886	3514	5429	15
21	6015	1502	5351	5086	4686	8669	4022	2253	3358	5837	69 0
15	5920	1746	5241	5371	4561	8995	3881	2619	3201	6244	45
30	5825	1990	5129	5655	4433	9320	3738	2985	3042	6650	30
45	5729	2233	5017	5939	4305	9645	3593	3350	2881	7056	15
22	5631	2476	4903	6222	4176	9969	3447	3715	2718	7461	68 0
15	5532	2719	4788	6505	4043	3.0292	3299	4078	2554	7865	45
30	5433	2961	4672	6788	3910	0615	3149	4442	2388	8268	30
45	5.5332	2.3203	6.4554	2.7070	7.3776	3.0937	8.2998	3.4804	9.2220	3.8671	15
23	5230	3414	4435	7351	3640	1258	2845	5166	2050	9073	67 0
15	5127	3685	4315	7632	3503	1580	2691	5527	1879	9474	45
30	5024	3925	4194	7912	3365	1900	2535	5887	1706	9875	30
45	4919	4165	4072	8192	3225	2220	2375	6247	1531	4.0275	15
24	4813	4404	3948	8472	3084	2539	2219	6606	1355	0674	66 0
15	4706	4643	3823	8750	2941	2858	2059	6965	1176	1072	45
30	4598	4882	3697	9029	2797	3175	1897	7322	0996	1469	30
45	4489	5120	3570	9306	2651	3493	1733	7679	0814	1866	15
25	4378	5357	3442	9583	2505	3809	1568	8036	0631	2262	65 0
15	5.4267	2.5594	6.3312	2.9800	7.2356	3.4125	8.1401	3.8391	9.0446	4.2657	45
30	4155	5831	3181	3.0136	2207	4441	1233	8746	0259	3051	30
45	4042	6067	3049	0411	2056	4756	1063	9100	0070	3445	15
26	3928	6302	2916	0686	1904	5070	0891	9453	8.9879	3837	64 0
15	3812	6537	2781	0960	1750	5383	0719	9806	9687	4229	45
30	3696	6772	2645	1234	1595	5696	0644	4.0158	9493	4620	30
45	3579	7006	2509	1507	1438	6008	0368	0509	9298	5010	15
27	3460	7239	2370	1779	1281	6319	0191	0859	9101	5399	63 0
15	3341	7472	2231	2051	1121	6630	0012	1209	8902	5787	45
30	3221	7705	2091	2322	0961	6940	7.9831	1557	8701	6175	30
45	5.3099	2.7937	6.1949	3.2593	7.0799	3.7249	7.9649	4.1905	8.8499	4.6561	15
28	2977	8168	1806	2863	0636	7558	9465	2252	8295	6947	62 0
15	2853	8399	1662	3132	6471	7866	9280	2599	8089	7332	45
30	2729	8630	1517	3401	0305	8173	9094	2944	7882	7716	30
45	2604	8859	1371	3669	0138	8479	8905	3289	7673	8099	15
29	2477	9089	1223	3937	6.9970	8785	8716	3683	7462	8481	61 0
15	2350	9317	1075	4203	9800	9090	8525	3976	7250	8862	45
30	2221	9545	0925	4470	9628	9394	8332	4318	7036	9242	30
45	2092	9773	0774	4735	9456	9697	8148	4659	6820	9622	15
30	1962	3.0000	0622	5000	9282	4.0000	7942	5000	6603	5.0000	60 0
	Dep.	Lat.	Dep.	Lat.	Dep.	Lat.	Dep.	Lat.	Dep.	Lat.	
	Dist. 6		Dist. 7		Dist. 8		Dist. 9		Dist. 10		Course

Course	Dist. 1		Dist. 2		Dist. 3		Dist. 4		Dist. 5		Course
	Lat.	Dep.	Lat.	Dep.	Lat.	Dep.	Lat.	Dep.	Lat.	Dep.	
30 15	0.8638	0.5038	1.7277	1.0075	2.5915	1.5113	3.4553	2.0151	4.3192	2.5189	59 45
30 30	8616	5075	7223	0151	5849	5226	4465	0302	3081	5377	30
30 45	8594	5113	7188	0226	5782	5339	4376	0452	2970	5565	15
31 0	8572	5150	7142	0301	5715	5451	4287	0602	2858	5752	59 0
31 15	8549	5188	7098	0375	5647	5563	4196	0751	2746	5939	45
31 30	8526	5225	7053	0450	5579	5075	4106	0900	2632	6125	30
31 45	8504	5262	7007	0524	5511	5786	4014	1049	2518	6311	15
32 0	8480	5299	6961	0598	5441	5898	3922	1197	2402	6496	58 0
32 15	8457	5336	6915	0672	5372	6008	3829	1345	2286	6681	45
32 30	8434	5373	6868	0746	5302	6119	3736	1492	2170	6865	30
32 45	0.8410	0.5410	1.6821	1.0819	2.5231	1.6229	3.3642	2.1639	4.2052	2.7049	15
33 0	8387	5446	6773	0893	5160	6339	3547	1786	1934	7232	57 0
33 15	8363	5483	6726	0966	5089	6449	3451	1932	1814	7415	45
33 30	8339	5519	6678	1039	5017	6558	3355	2077	1694	7597	30
33 45	8315	5556	6629	1111	4944	6667	3259	2223	1573	7779	15
34 0	8290	5592	6581	1184	4871	6776	3162	2368	1452	7960	56 0
34 15	8266	5628	6532	1256	4798	6884	3064	2512	1329	8140	45
34 30	8241	5664	6483	1328	4724	6992	2965	2656	1206	8323	30
34 45	8216	5700	6433	1400	4649	7100	2866	2800	1082	8500	15
35 0	8192	5736	6383	1472	4575	7207	2766	2943	0958	8679	55 0
35 15	0.8166	0.5771	1.6333	1.1543	2.4499	1.7314	3.2666	2.3086	4.0832	2.8857	45
35 30	8141	5807	6282	1614	4423	7421	2565	3228	0706	9035	30
35 45	8116	5842	6231	1685	4347	7527	2463	3370	0579	9212	15
36 0	8090	5878	6180	1756	4271	7634	2361	3511	0451	9389	54 0
36 15	8064	5913	6129	1826	4193	7739	2258	3652	0322	9565	45
36 30	8039	5948	6077	1896	4116	7845	2154	3793	0193	9741	30
36 45	8013	5983	6025	1966	4038	7950	2050	3933	0063	9916	15
37 0	7986	6018	5973	2036	3959	8054	1945	4073	3.9932	3.0091	53 0
37 15	7960	6053	5920	2106	3880	8159	1840	4212	9800	0365	45
37 30	7934	6088	5867	2175	3801	8263	1734	4350	9668	0438	30
37 45	0.7907	0.6122	1.5814	1.2244	2.3721	1.8367	3.1628	2.4489	3.9534	3.0611	15
38 0	7880	6157	5760	2313	3640	8470	1520	4626	9400	0783	52 0
38 15	7853	6191	5706	2482	3560	8573	1413	4764	9266	0955	45
38 30	7826	6225	5652	2450	3478	8675	1304	4901	9130	1126	30
38 45	7799	6259	5598	2518	3397	8778	1195	5037	8994	1296	15
39 0	7771	6293	5543	2586	3314	8880	1086	5173	8857	1466	51 0
39 15	7744	6327	5488	2654	3232	8981	0976	5308	8720	1635	45
39 30	7716	6361	5432	2722	3149	9082	0865	5443	8581	1804	30
39 45	7688	6394	5377	2789	3065	9183	0754	5578	8442	1972	15
40 0	7660	6428	5321	2856	2981	9284	0642	5512	8302	2139	50 0
40 15	0.7632	0.6461	1.5265	1.2922	2.2897	1.9384	3.0529	2.5845	3.8162	3.2306	45
40 30	7604	6494	5208	2989	2812	9463	0416	5978	8020	2472	30
40 45	7576	6528	5151	3055	2727	9583	0303	6110	7878	2638	15
41 0	7547	6561	5094	3121	2641	9682	0188	6242	7735	2803	49 0
41 15	7518	6593	5037	3187	2555	9780	0074	6374	7592	2967	45
41 30	7490	6626	4979	3252	2469	9879	2.9958	6505	7448	3131	30
41 45	7461	6659	4921	3318	2382	9976	9842	6635	7303	3294	15
42 0	7431	6891	4863	3383	2294	2.0074	9726	6765	7157	3457	48 0
42 15	7402	6724	4804	3447	2207	0171	9609	6895	7011	3618	45
42 30	7373	6756	4746	3512	2118	0268	9491	7024	6864	3780	30
42 45	0.7343	0.6788	1.4686	1.3576	2.2030	2.0364	2.9373	2.7152	3.6716	3.3940	15
43 0	7314	6820	4627	3640	1941	0460	9254	7280	6568	4100	47 0
43 15	7284	6852	4567	3704	1851	0555	9135	7407	6419	4259	45
43 30	7254	6884	4507	3767	1761	0651	9015	7534	6268	4418	30
43 45	7224	6915	4447	3830	1671	0745	8895	7661	6118	4576	15
44 0	7193	6947	4387	3893	1580	0840	8774	7786	5967	4733	46 0
44 15	7163	6978	4326	3956	1489	0934	8652	7912	5815	4890	45
44 30	7133	7009	4265	4018	1398	1027	8530	8036	5663	5045	30
44 45	7102	7040	4204	4080	1306	1120	8407	8161	5509	5201	15
45 0	7071	7071	4142	4142	1213	1213	8284	8284	5355	5355	45 0
	Dep.	Lat.	Dep.	Lat.	Dep.	Lat.	Dep.	Lat.	Dep.	Lat.	
	Dist. 1		Dist. 2		Dist. 3		Dist. 4		Dist. 5		Course

Course	Dist. 6		Dist. 7		Dist. 8		Dist. 9		Dist. 10		Course
	Lat.	Dep.	Lat.	Dep.	Lat.	Dep.	Lat.	Dep.	Lat.	Dep.	
30 15	5.1830	3.0226	6.0468	3.5264	6.9107	4.0302	7.7745	4 5340	8.6384	5.0377	59 45
30 30	1698	0452	0314	5528	8930	0603	7547	5678	6163	0754	30
30 45	1564	0678	0158	5791	8753	0903	7347	6016	5941	1129	15
31 0	1430	0902	0002	6053	8573	1203	7145	6353	5717	1504	59 0
31 15	1295	1126	5.9844	6314	8393	1502	6942	6690	5491	1877	45
31 30	1158	1350	9685	6575	8211	1800	6738	7025	5264	2250	30
31 45	1021	1573	9525	6835	8028	2097	6532	7359	5035	2621	15
32 0	0883	1795	9363	7094	7844	2394	6324	7693	4805	2992	58 0
32 15	0744	2017	9201	7353	7658	2689	6116	8025	4573	3361	45
32 30	0603	2238	9037	7611	7471	2984	5905	8357	4339	3730	30
32 45	5.0462	3.2458	5.8873	3.7868	6.7283	4.3278	7.5694	4.8688	8.4104	5.4097	15
33 0	0320	2678	8707	8125	7094	3571	5480	9018	3867	4464	57 0
33 15	0177	2898	8540	8381	6903	3803	5266	9346	3629	4829	45
33 30	0033	3116	8372	8636	6711	4155	5050	9674	3389	5194	30
33 45	4.9888	3334	8203	8890	6518	4446	4832	5.0001	3147	5557	15
34 0	9742	3552	8033	9144	6323	4735	4613	3207	2904	5919	56 0
34 15	9595	3768	7861	9396	6127	5024	4393	0652	2659	6280	45
34 30	9448	3984	7689	9648	5930	5312	4171	0977	2413	6641	30
34 45	9299	4200	7519	9900	5732	5600	3948	1300	2165	7000	15
35 0	9149	4415	7341	4.0150	5532	5886	3724	1622	1915	7358	55 0
35 15	4.8998	3.4629	5.7165	4.0400	6.5331	4.6172	7.3498	5.1943	8.1664	5.7715	45
35 30	8847	4842	6988	0649	5129	6456	3270	2263	1412	8070	30
35 45	8694	5055	6810	0897	4926	6740	3042	2582	1157	8425	15
36 0	8541	5267	6631	1145	4721	7023	2812	2901	0902	8779	54 0
36 15	8387	5479	6451	1392	4516	7305	2580	3218	0644	9131	45
36 30	8231	5689	6270	1638	4309	7586	2347	3534	0386	9482	30
36 45	8075	5899	6088	1883	4100	7866	2113	3849	0125	9832	15
37 0	7918	6109	5904	2127	3891	8145	1877	4193	7.9864	6.0182	53 0
37 15	7760	6318	5720	2371	3680	8424	1640	4476	9600	0529	45
37 30	7601	6526	5535	2613	3468	8701	1402	4789	9335	0876	30
37 45	4.7441	3.6733	5.5348	4.2855	6.3255	4.8977	7.1162	5.5100	7.9069	6.1222	15
38 0	7281	6940	5161	3096	3041	9253	0921	5410	8801	1566	52 0
38 15	7119	7146	4972	3337	2829	9528	0679	5718	8532	1909	45
38 30	6956	7351	4783	3576	2609	9801	0435	6026	8261	2251	30
38 45	6793	7555	4592	3815	2391	5.0074	0190	6333	7988	2592	15
39 0	6629	7759	4400	4052	2172	0346	6.9943	6639	7715	2932	51 0
39 15	6464	7962	4207	4289	1951	0616	9695	6943	7439	3271	45
39 30	6297	8165	4014	4525	1730	0886	9446	7247	7162	3608	30
39 45	6131	8366	3819	4761	1507	1155	9196	7550	6884	3944	15
40 0	5963	8567	3623	4995	1284	1423	8944	7851	6604	4279	50 0
40 15	4.5794	3.8767	5.3426	4.5229	6.1059	5.1690	6.8691	5.8151	7.6323	6.4612	45
40 30	5624	8967	3228	5461	0832	1956	8437	8450	6041	4945	30
40 45	5454	9166	3030	5693	0605	2221	8181	8748	5756	5276	15
41 0	5283	9364	2830	5924	0377	2485	7924	9045	5471	5606	49 0
41 15	5110	9561	2629	6154	0147	2748	7666	9341	5184	5935	45
41 30	4937	9757	2427	6383	5.9916	3010	7406	9638	4896	6282	30
41 45	4763	9953	2224	6612	9685	3271	7145	9929	4606	6588	15
42 0	4589	4.0148	2020	6839	9452	3530	6883	6.0222	4314	6913	48 0
42 15	4413	0342	1815	7066	9217	3789	6620	0513	4022	7237	45
42 30	4237	0535	1609	7291	8982	4047	6355	0803	3728	7559	30
42 45	4.4059	4.0728	5.1403	4.7516	5.8746	5.4304	6.6089	6.1092	7.3432	6.7880	15
43 0	3881	0920	1195	7740	8508	4560	5822	1380	3135	8200	47 0
43 15	3702	1111	0986	7963	8270	4815	5553	1666	2837	8518	45
43 30	3522	1301	0776	8185	8030	5068	5284	1952	2537	8835	30
43 45	3342	1491	0565	8406	7789	5321	5013	2236	2236	9151	15
44 0	3160	1680	0354	8626	7547	5573	4741	2519	1934	9466	46 0
44 15	2978	1867	0141	8845	7304	5823	4467	2801	1630	9779	45
44 30	2795	2055	4.9928	9064	7060	6073	4193	3082	1325	7.0091	30
44 45	2611	2241	9713	9281	6815	6321	3917	3361	1019	0401	15
45 0	2426	2426	9477	9497	6569	6569	3640	3640	0711	0711	45 0

## LOGARITHMS OF NUMBERS

No.	0	1	2	3	4	5	6	7	8	9
10	0000	0043	0086	0128	0170	0212	0253	0294	0334	0374
11	0414	0453	0492	0531	0569	0607	0645	0682	0719	0755
12	0792	0828	0864	0899	0934	0969	1004	1038	1072	1106
13	1139	1173	1206	1239	1271	1303	1335	1367	1399	1430
14	1461	1492	1523	1553	1584	1614	1644	1673	1703	1732
15	1761	1790	1818	1847	1875	1903	1931	1959	1987	2014
16	2041	2068	2095	2122	2148	2175	2201	2227	2253	2279
17	2304	2330	2355	2380	2405	2430	2455	2480	2504	2529
18	2553	2577	2601	2625	2648	2672	2695	2718	2742	2765
19	2788	2810	2833	2856	2878	2900	2923	2945	2967	2989
20	3010	3032	3054	3075	3096	3118	3139	3160	3181	3201
21	3222	3243	3263	3284	3304	3324	3345	3365	3385	3404
22	3424	3444	3464	3483	3502	3522	3541	3560	3579	3598
23	3617	3636	3655	3674	3692	3711	3729	3747	3766	3784
24	3802	3820	3838	3856	3874	3892	3909	3927	3945	3962
25	3979	3997	4014	4031	4048	4065	4082	4099	4116	4133
26	4150	4166	4183	4200	4216	4232	4249	4265	4281	4298
27	4314	4330	4346	4362	4378	4393	4409	4425	4440	4456
28	4472	4487	4502	4518	4533	4548	4564	4579	4594	4609
29	4624	4639	4654	4669	4683	4698	4713	4728	4742	4757
30	4771	4786	4800	4814	4829	4843	4857	4871	4886	4900
31	4914	4928	4942	4955	4969	4983	4997	5011	5024	5038
32	5051	5065	5079	5092	5105	5119	5132	5145	5159	5172
33	5185	5198	5211	5224	5237	5250	5263	5276	5289	5302
34	5315	5328	5340	5353	5366	5378	5391	5403	5416	5428
35	5441	5453	5465	5478	5490	5502	5514	5527	5539	5551
36	5563	5575	5587	5599	5611	5623	5635	5647	5658	5670
37	5682	5694	5705	5717	5729	5740	5752	5763	5775	5786
38	5798	5809	5821	5832	5843	5855	5866	5877	5888	5899
39	5911	5922	5933	5944	5955	5966	5977	5988	5999	6010
40	6021	6031	6042	6053	6064	6075	6085	6096	6107	6117
41	6128	6138	6149	6160	6170	6180	6191	6201	6212	6222
42	6232	6243	6253	6263	6274	6284	6294	6304	6314	6325
43	6335	6345	6355	6365	6375	6385	6395	6405	6415	6425
44	6435	6444	6454	6464	6474	6484	6493	6503	6513	6522
45	6532	6542	6551	6561	6571	6580	6590	6599	6609	6618
46	6628	6637	6646	6656	6665	6675	6684	6693	6702	6712
47	6721	6730	6739	6749	6758	6767	6776	6785	6794	6803
48	6812	6821	6830	6839	6848	6857	6866	6875	6884	6893
49	6902	6911	6920	6928	6937	6946	6955	6964	6972	6981
50	6990	6998	7007	7016	7024	7033	7042	7050	7059	7067
51	7076	7084	7093	7101	7110	7118	7126	7135	7143	7152
52	7160	7168	7177	7185	7193	7202	7210	7218	7226	7235
53	7243	7251	7259	7267	7275	7284	7292	7300	7308	7316
54	7324	7332	7340	7348	7356	7364	7372	7380	7388	7396
No.	0	1	2	3	4	5	6	7	8	9

LOGARITHMS OF NUMBERS

No.	0	1	2	3	4	5	6	7	8	9
55	7404	7412	7419	7427	7435	7443	7451	7459	7466	7474
56	7482	7490	7497	7505	7513	7520	7528	7536	7543	7551
57	7559	7566	7574	7582	7589	7597	7604	7612	7619	7627
58	7634	7642	7649	7657	7664	7672	7679	7686	7694	7701
59	7709	7716	7723	7731	7738	7745	7752	7760	7767	7774
60	7782	7789	7796	7803	7810	7818	7825	7832	7839	7846
61	7853	7860	7868	7875	7882	7889	7896	7903	7910	7917
62	7924	7931	7938	7945	7952	7959	7966	7973	7980	7987
63	7993	8000	8007	8014	8021	8028	8035	8041	8048	8055
64	8062	8069	8075	8082	8089	8096	8102	8109	8116	8122
65	8129	8136	8142	8149	8156	8162	8169	8176	8182	8189
66	8195	8202	8209	8215	8222	8228	8235	8241	8248	8254
67	8261	8267	8274	8280	8287	8293	8299	8306	8312	8319
68	8325	8331	8338	8344	8351	8357	8363	8370	8376	8382
69	8388	8395	8401	8407	8414	8420	8426	8432	8439	8445
70	8451	8457	8463	8470	8476	8482	8488	8494	8500	8506
71	8513	8519	8525	8531	8537	8543	8549	8555	8561	8567
72	8573	8579	8585	8591	8597	8603	8609	8615	8621	8627
73	8633	8639	8645	8651	8657	8663	8669	8675	8681	8686
74	8692	8698	8704	8710	8716	8722	8727	8733	8739	8745
75	8751	8756	8762	8768	8774	8779	8785	8791	8797	8802
76	8808	8814	8820	8825	8831	8837	8842	8848	8854	8859
77	8865	8871	8876	8882	8887	8893	8899	8904	8910	8915
78	8921	8927	8932	8938	8943	8949	8954	8960	8965	8971
79	8976	8982	8987	8993	8998	9004	9009	9015	9020	9025
80	9031	9036	9042	9047	9053	9058	9063	9069	9074	9079
81	9085	9090	9096	9101	9106	9112	9117	9122	9128	9133
82	9138	9143	9149	9154	9159	9165	9170	9175	9180	9186
83	9191	9196	9201	9206	9212	9217	9222	9227	9232	9238
84	9243	9248	9253	9258	9263	9269	9274	9279	9284	9289
85	9294	9299	9304	9309	9315	9320	9325	9330	9335	7340
86	9345	9350	9355	9360	9365	9370	9375	9380	9385	9390
87	9395	9400	9405	9410	9415	9420	9425	9430	9435	9440
88	9445	9450	9455	9460	9465	9469	9474	9479	9484	9489
89	9494	9499	9504	9509	9513	9518	9523	9528	9533	9538
90	9542	9547	9552	9557	9562	9566	9571	9576	9581	9586
91	9590	9595	9600	9605	9609	9614	9619	9624	9628	9633
92	9638	9643	9647	9652	9657	9661	9666	9671	9675	9680
93	9685	9689	9694	9699	9703	9708	9713	9717	9722	9727
94	9731	9736	9741	9745	9750	9754	9759	9763	9768	9773
95	9777	9782	9786	9791	9795	9800	9805	9809	9814	9818
96	9823	9827	9832	9836	9841	9845	9850	9854	9859	9863
97	9868	9872	9877	9881	9886	9890	9894	9899	9903	9908
98	9912	9917	9921	9926	9930	9934	9939	9943	9948	9952
99	9956	9961	9965	9969	9974	9978	9983	9987	9991	9996
No.	0	1	2	3	4	5	6	7	8	9

## LOGARITHMIC SINES, COSINES,

Angle	Sin.	D. 1'	Cos.	D. 1'	Tan.	D. 1'	Cot.	
0° 0'	— ∞		10.0000		— ∞		∞	90° 0'
0° 10'	7.4637	301.1	.0000	.0	7.4637	301.1	2.5363	89° 50'
0° 20'	.7648	176.0	.0000	.0	.7648	176.1	.2352	89° 40'
0° 30'	.9408	125.0	.0000	.0	.9409	124.9	.0591	89° 30'
0° 40'	8.0656	96.9	.0000	.0	8.0658	96.9	1.9342	89° 20'
0° 50'	.1627	79.2	.0000	.1	.1627	79.2	.8373	89° 10'
1° 0'	8.2419	66.9	9.9999	.0	8.2419	67.0	1.7581	89° 0'
1° 10'	.3088	58.0	.9999	.0	.3089	58.0	.6911	88° 50'
1° 20'	.3668	51.1	.9999	.0	.3669	51.2	.6331	88° 40'
1° 30'	.4179	45.8	.9999	.1	.4181	45.7	.5819	88° 30'
1° 40'	.4637	41.3	.9998	.0	.4638	41.5	.5362	88° 20'
1° 50'	.5050	37.8	.9998	.1	.5053	37.8	.4947	88° 10'
2° 0'	8.5428	34.8	9.9997	.0	8.5431	34.8	1.4569	88° 0'
2° 10'	.5776	32.1	.9997	.1	.5779	32.2	.4221	87° 50'
2° 20'	.6097	30.0	.9996	.0	.6101	30.0	.3899	87° 40'
2° 30'	.6397	28.0	.9996	.1	.6401	28.1	.3599	87° 30'
2° 40'	.6677	26.3	.9995	.0	.6682	26.3	.3318	87° 20'
2° 50'	.6940	24.8	.9995	.1	.6945	24.9	.3055	87° 10'
3° 0'	8.7188	23.5	9.9994	.1	8.7194	23.5	1.2806	87° 0'
3° 10'	.7423	22.2	.9993	.0	.7429	22.3	.2571	86° 50'
3° 20'	.7645	21.2	.9993	.1	.7652	21.3	.2348	86° 40'
3° 30'	.7857	20.2	.9992	.1	.7865	20.2	.2135	86° 30'
3° 40'	.8059	19.2	.9991	.1	.8067	19.4	.1933	86° 20'
3° 50'	.8251	18.5	.9990	.1	.8261	18.5	.1739	86° 10'
4° 0'	8.8436	17.7	9.9989	.0	8.8446	17.8	1.1554	86° 0'
4° 10'	.8613	17.0	.9989	.1	.8624	17.1	.1376	85° 50'
4° 20'	.8783	16.3	.9988	.1	.8795	16.5	.1205	85° 40'
4° 30'	.8946	15.8	.9987	.1	.8960	15.8	.1040	85° 30'
4° 40'	.9104	15.2	.9986	.1	.9118	15.4	.0882	85° 20'
4° 50'	.9256	14.7	.9985	.2	.9272	14.8	.0728	85° 10'
5° 0'	8.9403	14.2	9.9983	.1	8.9420	14.3	1.0580	85° 0'
5° 10'	.9545	13.7	.9982	.1	.9563	13.8	.0437	84° 50'
5° 20'	.9682	13.4	.9981	.1	.9701	13.5	.0299	84° 40'
5° 30'	.9816	12.9	.9980	.1	.9836	13.0	.0164	84° 30'
5° 40'	.9945	12.5	.9979	.2	.9966	12.7	.0034	84° 20'
5° 50'	9.0070	12.2	.9977	.1	9.0093	12.3	0.9907	84° 10'
6° 0'	9.0192	11.9	9.9976	.1	9.0216	12.0	0.9784	84° 0'
6° 10'	.0311	11.5	.9975	.2	.0336	11.7	.9664	83° 50'
6° 20'	.0426	11.3	.9973	.1	.0453	11.4	.9547	83° 40'
6° 30'	.0539	10.9	.9972	.1	.0567	11.1	.9433	83° 30'
6° 40'	.0648	10.7	.9971	.1	.0678	10.8	.9322	83° 20'
6° 50'	.0755	10.4	.9969	.1	.0786	10.5	.9214	83° 10'
7° 0'	9.0859	10.2	9.9968	.2	9.0891	10.4	0.9109	83° 0'
7° 10'	.0961	9.9	.9966	.2	.0995	10.1	.9005	82° 50'
7° 20'	.1060	9.7	.9964	.2	.1096	9.8	.8904	82° 40'
7° 30'	.1157		.9963	.1	.1194		.8806	82° 30'
	Cos.	D. 1'	Sin.	D. 1'	Cot.	D. 1'	Tan.	Angle

TANGENTS, AND COTANGENTS

Angle	Sin.	D. 1'	Cos.	D. 1'	Tan.	D. 1'	Cot.	
7° 30'	9.1157		9.9963		9.1194		0.8806	82° 30'
7° 40'	.1252	9.5	.9961	.2	.1291	9.7	.8709	82° 20'
7° 50'	.1345	9.3	.9959	.2	.1385	9.4	.8615	82° 10'
8° 0'	9.1436	9.1	9.9958	.1	9.1478	9.3	0.8522	82° 0'
8° 10'	.1525	8.9	.9956	.2	.1569	9.1	.8431	81° 50'
8° 20'	.1612	8.7	.9954	.2	.1658	8.9	.8342	81° 40'
8° 30'	.1697	8.5	.9952	.2	.1745	8.7	.8255	81° 30'
8° 40'	.1781	8.4	.9950	.2	.1831	8.6	.8169	81° 20'
8° 50'	.1863	8.2	.9948	.2	.1915	8.4	.8085	81° 10'
9° 0'	9.1943	8.0	9.9946	.2	9.1997	8.2	0.8003	81° 0'
9° 10'	.2022	7.9	.9944	.2	.2078	8.1	.7922	80° 50'
9° 20'	.2100	7.8	.9942	.2	.2158	8.0	.7842	80° 40'
9° 30'	.2176	7.6	.9940	.2	.2236	7.8	.7764	80° 30'
9° 40'	.2251	7.5	.9938	.2	.2313	7.7	.7687	80° 20'
9° 50'	.2324	7.3	.9936	.2	.2389	7.6	.7611	80° 10'
10° 0'	9.2397	7.3	9.9934	.2	9.2463	7.4	0.7537	80° 0'
10° 10'	.2468	7.1	.9931	.3	.2536	7.3	.7464	79° 50'
10° 20'	.2538	7.0	.9929	.2	.2609	7.3	.7391	79° 40'
10° 30'	.2606	6.8	.9927	.2	.2680	7.1	.7320	79° 30'
10° 40'	.2674	6.8	.9924	.3	.2750	7.0	.7250	79° 20'
10° 50'	.2740	6.6	.9922	.2	.2819	6.9	.7181	79° 10'
11° 0'	9.2806	6.6	9.9919	.3	9.2887	6.8	0.7113	79° 0'
11° 10'	.2870	6.4	.9917	.2	.2953	6.6	.7047	78° 50'
11° 20'	.2934	6.4	.9914	.3	.3020	6.7	.6980	78° 40'
11° 30'	.2997	6.3	.9912	.2	.3085	6.5	.6915	78° 30'
11° 40'	.3058	6.1	.9909	.3	.3149	6.4	.6851	78° 20'
11° 50'	.3119	6.1	.9907	.2	.3212	6.3	.6788	78° 10'
12° 0'	9.3179	6.0	9.9904	.3	9.3275	6.3	0.6725	78° 0'
12° 10'	.3238	5.9	.9901	.2	.3336	6.1	.6664	77° 50'
12° 20'	.3296	5.8	.9899	.3	.3397	6.1	.6603	77° 40'
12° 30'	.3353	5.7	.9896	.3	.3458	6.1	.6542	77° 30'
12° 40'	.3410	5.7	.9893	.3	.3517	5.9	.6483	77° 20'
12° 50'	.3466	5.6	.9890	.3	.3576	5.9	.6424	77° 10'
13° 0'	9.3521	5.5	9.9887	.3	9.3634	5.8	0.6366	77° 0'
13° 10'	.3575	5.4	.9884	.3	.3691	5.7	.6309	76° 50'
13° 20'	.3629	5.4	.9881	.3	.3748	5.7	.6252	76° 40'
13° 30'	.3682	5.3	.9878	.3	.3804	5.6	.6196	76° 30'
13° 40'	.3734	5.2	.9875	.3	.3859	5.5	.6141	76° 20'
13° 50'	.3786	5.2	.9872	.3	.3914	5.5	.6086	76° 10'
14° 0'	9.3837	5.1	9.9869	.3	9.3968	5.4	0.6032	76° 0'
14° 10'	.3887	5.0	.9866	.3	.4021	5.3	.5979	75° 50'
14° 20'	.3937	5.0	.9863	.3	.4074	5.3	.5926	75° 40'
14° 30'	.3986	4.9	.9859	.4	.4127	5.3	.5873	75° 30'
14° 40'	.4035	4.9	.9856	.3	.4178	5.1	.5822	75° 20'
14° 50'	.4083	4.8	.9853	.3	.4230	5.2	.5770	75° 10'
15° 0'	9.4130	4.7	9.9849	.4	9.4281	5.1	0.5719	75° 0'
	Cos.	D. 1'	Sin.	D. 1'	Cot.	D. 1'	Tan.	Angle

## LOGARITHMIC SINES, COSINES,

Angle	Sin.	D. 1'	Cos.	D. 1'	Tan.	D. 1'	Cot.	
15° 0'	9.4130	4.7	9.9849	.3	9.4281	5.0	0.5719	75° 0'
15° 10'	.4177	4.6	.9846	.3	.4331	5.0	.5669	74° 50'
15° 20'	.4223	4.6	.9843	.4	.4381	4.9	.5619	74° 40'
15° 30'	.4269	4.5	.9839	.4	.4430	4.9	.5570	74° 30'
15° 40'	.4314	4.5	.9836	.4	.4479	4.8	.5521	74° 20'
15° 50'	.4359	4.4	.9832	.4	.4527	4.8	.5473	74° 10'
16° 0'	9.4403	4.4	9.9828	.3	9.4575	4.7	0.5425	74° 0'
16° 10'	.4447	4.4	.9825	.4	.4622	4.7	.5378	73° 50'
16° 20'	.4491	4.2	.9821	.4	.4669	4.7	.5331	73° 40'
16° 30'	.4533	4.2	.9817	.4	.4716	4.6	.5284	73° 30'
16° 40'	.4576	4.2	.9814	.4	.4762	4.6	.5238	73° 20'
16° 50'	.4618	4.1	.9810	.4	.4808	4.5	.5192	73° 10'
17° 0'	9.4659	4.1	9.9806	.4	9.4853	4.5	0.5147	73° 0'
17° 10'	.4700	4.1	.9802	.4	.4898	4.5	.5102	72° 50'
17° 20'	.4741	4.0	.9798	.4	.4943	4.4	.5057	72° 40'
17° 30'	.4781	4.0	.9794	.4	.4987	4.4	.5013	72° 30'
17° 40'	.4821	4.0	.9790	.4	.5031	4.4	.4969	72° 20'
17° 50'	.4861	3.9	.9786	.4	.5075	4.3	.4925	72° 10'
18° 0'	9.4900	3.9	9.9782	.4	9.5118	4.3	0.4882	72° 0'
18° 10'	.4939	3.8	.9778	.4	.5161	4.2	.4839	71° 50'
18° 20'	.4977	3.8	.9774	.4	.5203	4.2	.4797	71° 40'
18° 30'	.5015	3.7	.9770	.5	.5245	4.2	.4755	71° 30'
18° 40'	.5052	3.8	.9765	.4	.5287	4.2	.4713	71° 20'
18° 50'	.5090	3.6	.9761	.4	.5329	4.1	.4671	71° 10'
19° 0'	9.5126	3.7	9.9757	.5	9.5370	4.1	0.4630	71° 0'
19° 10'	.5163	3.6	.9752	.4	.5411	4.0	.4589	70° 50'
19° 20'	.5199	3.6	.9748	.5	.5451	4.0	.4549	70° 40'
19° 30'	.5235	3.5	.9743	.4	.5491	4.0	.4509	70° 30'
19° 40'	.5270	3.6	.9739	.5	.5531	4.0	.4469	70° 20'
19° 50'	.5306	3.5	.9734	.4	.5571	4.0	.4429	70° 10'
20° 0'	9.5341	3.4	9.9730	.5	9.5611	3.9	0.4389	70° 0'
20° 10'	.5375	3.4	.9725	.4	.5650	3.9	.4350	69° 50'
20° 20'	.5409	3.4	.9721	.5	.5689	3.8	.4311	69° 40'
20° 30'	.5443	3.4	.9716	.5	.5727	3.9	.4273	69° 30'
20° 40'	.5477	3.3	.9711	.5	.5766	3.8	.4234	69° 20'
20° 50'	.5510	3.3	.9706	.4	.5804	3.8	.4196	69° 10'
21° 0'	9.5543	3.3	9.9702	.5	9.5842	3.7	0.4158	69° 0'
21° 10'	.5576	3.3	.9697	.5	.5879	3.8	.4121	68° 50'
21° 20'	.5609	3.2	.9692	.5	.5917	3.7	.4083	68° 40'
21° 30'	.5641	3.2	.9687	.5	.5954	3.7	.4046	68° 30'
21° 40'	.5673	3.1	.9682	.5	.5991	3.7	.4009	68° 20'
21° 50'	.5704	3.2	.9677	.5	.6028	3.6	.3972	68° 10'
22° 0'	9.5736	3.1	9.9672	.5	9.6064	3.6	0.3936	68° 0'
22° 10'	.5767	3.1	.9667	.6	.6100	3.6	.3900	67° 50'
22° 20'	.5798	3.0	.9661	.5	.6136	3.6	.3864	67° 40'
22° 30'	.5828		.9656		.6172		.3828	67° 30'
	<b>Cos.</b>	<b>D. 1'</b>	<b>Sin.</b>	<b>D. 1'</b>	<b>Cot.</b>	<b>D. 1'</b>	<b>Tan.</b>	<b>Angle</b>

TANGENTS, AND COTANGENTS

Angle	Sin.	D. 1'	Cos.	D. 1'	Tan.	D. 1'	Cot.	
22° 30'	9.5828	3.1	9.9656	.5	9.6172	3.6	0.3828	67° 30'
22° 40'	.5859	3.0	.9651	.5	.6208	3.5	.3792	67° 20'
22° 50'	.5889	3.0	.9646	.6	.6243	3.6	.3757	67° 10'
<b>23° 0'</b>	<b>9.5919</b>	<b>2.9</b>	<b>9.9640</b>	<b>.5</b>	<b>9.6279</b>	<b>3.5</b>	<b>0.3721</b>	<b>67° 0'</b>
23° 10'	.5948	3.0	.9635	.6	.6314	3.4	.3686	66° 50'
23° 20'	.5978	2.9	.9629	.5	.6348	3.5	.3652	66° 40'
23° 30'	.6007	2.9	.9624	.6	.6383	3.4	.3617	66° 30'
23° 40'	.6036	2.9	.9618	.5	.6417	3.5	.3583	66° 20'
23° 50'	.6065	2.8	.9613	.6	.6452	3.4	.3548	66° 10'
<b>24° 0'</b>	<b>9.6093</b>	<b>2.8</b>	<b>9.9607</b>	<b>.5</b>	<b>9.6486</b>	<b>3.4</b>	<b>0.3514</b>	<b>66° 0'</b>
24° 10'	.6121	2.8	.9602	.6	.6520	3.3	.3480	65° 50'
24° 20'	.6149	2.8	.9596	.6	.6553	3.4	.3447	65° 40'
24° 30'	.6177	2.8	.9590	.6	.6587	3.3	.3413	65° 30'
24° 40'	.6205	2.7	.9584	.5	.6620	3.4	.3380	65° 20'
24° 50'	.6232	2.7	.9579	.6	.6654	3.3	.3346	65° 10'
<b>25° 0'</b>	<b>9.6259</b>	<b>2.7</b>	<b>9.9573</b>	<b>.6</b>	<b>9.6687</b>	<b>3.3</b>	<b>0.3313</b>	<b>65° 0'</b>
25° 10'	.6286	2.7	.9567	.6	.6720	3.2	.3280	64° 50'
25° 20'	.6313	2.7	.9561	.6	.6752	3.3	.3248	64° 40'
25° 30'	.6340	2.6	.9555	.6	.6785	3.2	.3215	64° 30'
25° 40'	.6366	2.6	.9549	.6	.6817	3.3	.3183	64° 20'
25° 50'	.6392	2.6	.9543	.6	.6850	3.2	.3150	64° 10'
<b>26° 0'</b>	<b>9.6418</b>	<b>2.6</b>	<b>9.9537</b>	<b>.7</b>	<b>9.6882</b>	<b>3.2</b>	<b>0.3118</b>	<b>64° 0'</b>
26° 10'	.6444	2.6	.9530	.6	.6914	3.2	.3086	63° 50'
26° 20'	.6470	2.5	.9524	.6	.6946	3.1	.3054	63° 40'
26° 30'	.6495	2.6	.9518	.6	.6977	3.2	.3023	63° 30'
26° 40'	.6521	2.5	.9512	.6	.7009	3.1	.2991	63° 20'
26° 50'	.6546	2.4	.9505	.6	.7040	3.2	.2960	63° 10'
<b>27° 0'</b>	<b>9.6570</b>	<b>2.5</b>	<b>9.9499</b>	<b>.7</b>	<b>9.7072</b>	<b>3.1</b>	<b>0.2928</b>	<b>63° 0'</b>
27° 10'	.6595	2.5	.9492	.6	.7103	3.1	.2897	62° 50'
27° 20'	.6620	2.4	.9486	.7	.7134	3.1	.2866	62° 40'
27° 30'	.6644	2.4	.9479	.6	.7165	3.1	.2835	62° 30'
27° 40'	.6668	2.4	.9473	.7	.7196	3.0	.2804	62° 20'
27° 50'	.6692	2.4	.9466	.7	.7226	3.1	.2774	62° 10'
<b>28° 0'</b>	<b>9.6716</b>	<b>2.4</b>	<b>9.9459</b>	<b>.6</b>	<b>9.7257</b>	<b>3.0</b>	<b>0.2743</b>	<b>62° 0'</b>
28° 10'	.6740	2.3	.9453	.7	.7287	3.0	.2713	61° 50'
28° 20'	.6763	2.4	.9446	.7	.7317	3.1	.2683	61° 40'
28° 30'	.6787	2.3	.9439	.7	.7348	3.0	.2652	61° 30'
28° 40'	.6810	2.3	.9432	.7	.7378	3.0	.2622	61° 20'
28° 50'	.6833	2.3	.9425	.7	.7408	3.0	.2592	61° 10'
<b>29° 0'</b>	<b>9.6856</b>	<b>2.2</b>	<b>9.9418</b>	<b>.7</b>	<b>9.7438</b>	<b>2.9</b>	<b>0.2562</b>	<b>61° 0'</b>
29° 10'	.6878	2.3	.9411	.7	.7467	3.0	.2533	60° 50'
29° 20'	.6901	2.2	.9404	.7	.7497	2.9	.2503	60° 40'
29° 30'	.6923	2.3	.9397	.7	.7526	3.0	.2474	60° 30'
29° 40'	.6946	2.2	.9390	.7	.7556	2.9	.2444	60° 20'
29° 50'	.6968	2.2	.9383	.7	.7585	2.9	.2415	60° 10'
<b>30° 0'</b>	<b>9.6990</b>		<b>9.9375</b>	<b>.8</b>	<b>9.7614</b>	<b>2.9</b>	<b>0.2386</b>	<b>60° 0'</b>
	<b>Cos.</b>	<b>D. 1'</b>	<b>Sin.</b>	<b>D. 1'</b>	<b>Cot.</b>	<b>D. 1'</b>	<b>Tan.</b>	<b>Angle</b>

## LOGARITHMIC SINES, COSINES,

Angle	Sin.	D. 1'	Cos.	D. 1'	Tan.	D. 1'	Cot.	
<b>30° 0'</b>	9.6990	2.2	9.9375	.7	9.7614	3.0	0.2386	<b>60° 0'</b>
30° 10'	.7012	2.1	.9368	.7	.7644	2.9	.2356	59° 50'
30° 20'	.7033	2.2	.9361	.8	.7673	2.8	.2327	59° 40'
30° 30'	.7055	2.1	.9353	.7	.7701	2.9	.2299	59° 30'
30° 40'	.7076	2.1	.9346	.8	.7730	2.9	.2270	59° 20'
30° 50'	.7097	2.1	.9338	.7	.7759	2.9	.2241	59° 10'
<b>31° 0'</b>	9.7118	2.1	9.9331	.8	9.7788	2.8	0.2212	<b>59° 0'</b>
31° 10'	.7139	2.1	.9323	.8	.7816	2.9	.2184	58° 50'
31° 20'	.7160	2.1	.9315	.7	.7845	2.8	.2155	58° 40'
31° 30'	.7181	2.0	.9308	.8	.7873	2.9	.2127	58° 30'
31° 40'	.7201	2.1	.9300	.8	.7902	2.8	.2098	58° 20'
31° 50'	.7222	2.0	.9292	.8	.7930	2.8	.2070	58° 10'
<b>32° 0'</b>	9.7242	2.0	9.9284	.8	9.7958	2.8	0.2042	<b>58° 0'</b>
32° 10'	.7262	2.0	.9276	.8	.7986	2.8	.2014	57° 50'
32° 20'	.7282	2.0	.9268	.8	.8014	2.8	.1986	57° 40'
32° 30'	.7302	2.0	.9260	.8	.8042	2.8	.1958	57° 30'
32° 40'	.7322	2.0	.9252	.8	.8070	2.7	.1930	57° 20'
32° 50'	.7342	1.9	.9244	.8	.8097	2.8	.1903	57° 10'
<b>33° 0'</b>	9.7361	1.9	9.9236	.8	9.8125	2.8	0.1875	<b>57° 0'</b>
33° 10'	.7380	2.0	.9228	.9	.8153	2.7	.1847	56° 50'
33° 20'	.7400	1.9	.9219	.8	.8180	2.8	.1820	56° 40'
33° 30'	.7419	1.9	.9211	.8	.8208	2.7	.1792	56° 30'
33° 40'	.7438	1.9	.9203	.9	.8235	2.8	.1765	56° 20'
33° 50'	.7457	1.9	.9194	.8	.8263	2.7	.1737	56° 10'
<b>34° 0'</b>	9.7476	1.8	9.9186	.9	9.8290	2.7	0.1710	<b>56° 0'</b>
34° 10'	.7494	1.9	.9177	.8	.8317	2.7	.1683	55° 50'
34° 20'	.7513	1.8	.9169	.9	.8344	2.7	.1656	55° 40'
34° 30'	.7531	1.9	.9160	.9	.8371	2.7	.1629	55° 30'
34° 40'	.7550	1.8	.9151	.9	.8398	2.7	.1602	55° 20'
34° 50'	.7568	1.8	.9142	.8	.8425	2.7	.1575	55° 10'
<b>35° 0'</b>	9.7586	1.8	9.9134	.9	9.8452	2.7	0.1548	<b>55° 0'</b>
35° 10'	.7604	1.8	.9125	.9	.8479	2.7	.1521	54° 50'
35° 20'	.7622	1.8	.9116	.9	.8506	2.7	.1494	54° 40'
35° 30'	.7640	1.7	.9107	.9	.8533	2.6	.1467	54° 30'
35° 40'	.7657	1.8	.9098	.9	.8559	2.7	.1441	54° 20'
35° 50'	.7675	1.7	.9089	.9	.8586	2.7	.1414	54° 10'
<b>36° 0'</b>	9.7692	1.8	9.9080	1.0	9.8613	2.6	0.1387	<b>54° 0'</b>
36° 10'	.7710	1.7	.9070	.9	.8639	2.7	.1361	53° 50'
36° 20'	.7727	1.7	.9061	.9	.8666	2.6	.1334	53° 40'
36° 30'	.7744	1.7	.9052	1.0	.8692	2.6	.1308	53° 30'
36° 40'	.7761	1.7	.9042	.9	.8718	2.7	.1282	53° 20'
36° 50'	.7778	1.7	.9033	1.0	.8745	2.6	.1255	53° 10'
<b>37° 0'</b>	9.7795	1.6	9.9023	.9	9.8771	2.6	0.1229	<b>53° 0'</b>
37° 10'	.7811	1.7	.9014	1.0	.8797	2.7	.1203	52° 50'
37° 20'	.7828	1.6	.9004	.9	.8824	2.6	.1176	52° 40'
37° 30'	.7844		.8995		.8850		.1150	52° 30'
	<b>Cos.</b>	<b>D. 1'</b>	<b>Sin.</b>	<b>D. 1'</b>	<b>Cot.</b>	<b>D. 1'</b>	<b>Tan.</b>	<b>Angle</b>

TANGENTS, AND COTANGENTS

Angle	Sin.	D. 1'	Cos	D.1'	Tan.	D. 1'	Cot.	
37° 30'	9.7844		9.8995		9.8850		0.1150	52° 30'
37° 40'	.7861	1.7	.8985	1.0	.8876	2.6	.1124	52° 20'
37° 50'	.7877	1.6	.8975	1.0	.8902	2.6	.1098	52° 10'
<b>38° 0'</b>	<b>9.7893</b>	<b>1.7</b>	<b>9.8965</b>	<b>1.0</b>	<b>9.8928</b>	<b>2.6</b>	<b>0.1072</b>	<b>52° 0'</b>
38° 10'	.7910	1.6	.8955	1.0	.8954	2.6	.1046	51° 50'
38° 20'	.7926	1.5	.8945	1.0	.8980	2.6	.1020	51° 40'
38° 30'	.7941	1.5	.8935	1.0	.9006	2.6	.0994	51° 30'
38° 40'	.7957	1.6	.8925	1.0	.9032	2.6	.0968	51° 20'
38° 50'	.7973	1.6	.8915	1.0	.9058	2.6	.0942	51° 10'
<b>39° 0'</b>	<b>9.7989</b>	<b>1.5</b>	<b>9.8905</b>	<b>1.0</b>	<b>9.9084</b>	<b>2.6</b>	<b>0.0916</b>	<b>51° 0'</b>
39° 10'	.8004	1.6	.8895	1.1	.9110	2.5	.0890	50° 50'
39° 20'	.8020	1.5	.8884	1.0	.9135	2.6	.0865	50° 40'
39° 30'	.8035	1.5	.8874	1.0	.9161	2.6	.0839	50° 30'
39° 40'	.8050	1.6	.8864	1.0	.9187	2.6	.0813	50° 20'
39° 50'	.8066	1.5	.8853	1.1	.9212	2.5	.0788	50° 10'
<b>40° 0'</b>	<b>9.8081</b>	<b>1.5</b>	<b>9.8843</b>	<b>1.0</b>	<b>9.9238</b>	<b>2.6</b>	<b>0.0762</b>	<b>50° 0'</b>
40° 10'	.8096	1.5	.8832	1.1	.9264	2.5	.0736	49° 50'
40° 20'	.8111	1.4	.8821	1.1	.9289	2.6	.0711	49° 40'
40° 30'	.8125	1.4	.8810	1.1	.9315	2.6	.0685	49° 30'
40° 40'	.8140	1.5	.8800	1.0	.9341	2.6	.0659	49° 20'
40° 50'	.8155	1.4	.8789	1.1	.9366	2.5	.0634	49° 10'
<b>41° 0'</b>	<b>9.8169</b>	<b>1.5</b>	<b>9.8778</b>	<b>1.1</b>	<b>9.9392</b>	<b>2.5</b>	<b>0.0608</b>	<b>49° 0'</b>
41° 10'	.8184	1.4	.8767	1.1	.9417	2.6	.0583	48° 50'
41° 20'	.8198	1.5	.8756	1.1	.9443	2.5	.0557	48° 40'
41° 30'	.8213	1.4	.8745	1.1	.9468	2.6	.0532	48° 30'
41° 40'	.8227	1.4	.8733	1.2	.9494	2.6	.0506	48° 20'
41° 50'	.8241	1.4	.8722	1.1	.9519	2.5	.0481	48° 10'
<b>42° 0'</b>	<b>9.8255</b>	<b>1.4</b>	<b>9.8711</b>	<b>1.1</b>	<b>9.9544</b>	<b>2.6</b>	<b>0.0456</b>	<b>48° 0'</b>
42° 10'	.8269	1.4	.8699	1.2	.9570	2.5	.0430	47° 50'
42° 20'	.8283	1.4	.8688	1.1	.9595	2.6	.0405	47° 40'
42° 30'	.8297	1.4	.8676	1.2	.9621	2.6	.0379	47° 30'
42° 40'	.8311	1.4	.8665	1.1	.9646	2.5	.0354	47° 20'
42° 50'	.8324	1.3	.8653	1.2	.9671	2.5	.0329	47° 10'
<b>43° 0'</b>	<b>9.8338</b>	<b>1.3</b>	<b>9.8641</b>	<b>1.2</b>	<b>9.9697</b>	<b>2.5</b>	<b>0.0303</b>	<b>47° 0'</b>
43° 10'	.8351	1.4	.8629	1.2	.9722	2.5	.0278	46° 50'
43° 20'	.8365	1.3	.8618	1.1	.9747	2.5	.0253	46° 40'
43° 30'	.8378	1.3	.8606	1.2	.9772	2.5	.0228	46° 30'
43° 40'	.8391	1.3	.8594	1.2	.9798	2.6	.0202	46° 20'
43° 50'	.8405	1.4	.8582	1.2	.9823	2.5	.0177	46° 10'
<b>44° 0'</b>	<b>9.8418</b>	<b>1.3</b>	<b>9.8569</b>	<b>1.3</b>	<b>9.9848</b>	<b>2.6</b>	<b>0.0152</b>	<b>46° 0'</b>
44° 10'	.8431	1.3	.8557	1.2	.9874	2.5	.0126	45° 50'
44° 20'	.8444	1.3	.8545	1.2	.9899	2.5	.0101	45° 40'
44° 30'	.8457	1.2	.8532	1.3	.9924	2.5	.0076	45° 30'
44° 40'	.8469	1.2	.8520	1.2	.9949	2.5	.0051	45° 20'
44° 50'	.8482	1.3	.8507	1.3	.9975	2.6	.0025	45° 10'
<b>45° 0'</b>	<b>9.8495</b>	<b>1.3</b>	<b>9.8495</b>	<b>1.2</b>	<b>0.0000</b>	<b>2.5</b>	<b>0.0000</b>	<b>45° 0'</b>
	<b>Cos.</b>	<b>D. 1'</b>	<b>Sin.</b>	<b>D. 1'</b>	<b>Cot.</b>	<b>D. 1'</b>	<b>Tan.</b>	<b>Angle</b>

LOGARITHMIC SINES AND TANGENTS OF SMALL ANGLES

0° 1° 2° 3° 4° 5°

°	0°	1°	2°	3°	4°	5°	'	
0	L Sin	L Tan	L Sin	L Tan	L Sin	L Tan	L Sin	L Tan
1	6.46 37	8.24 19	8.54 28	8.71 88	8.84 36	8.84 46	8.94 03	8.94 19
2	6.76 48	8.24 91	8.54 64	8.72 12	8.84 54	8.84 65	8.94 17	8.94 34
3	6.94 08	8.25 62	8.55 00	8.72 36	8.84 72	8.84 83	8.94 32	8.94 48
4	7.06 58	8.26 31	8.55 35	8.72 60	8.85 00	8.85 11	8.94 46	8.94 63
5	7.16 27	8.27 00	8.55 70	8.72 83	8.85 07	8.85 18	8.94 72	8.94 92
6	7.24 19	8.27 67	8.56 05	8.73 07	8.85 25	8.85 36	8.94 75	8.94 97
7	7.30 88	8.28 33	8.56 40	8.73 30	8.85 43	8.85 54	8.94 89	8.95 06
8	7.36 68	8.28 99	8.56 74	8.73 53	8.85 60	8.85 72	8.95 03	8.95 20
9	7.41 80	8.29 63	8.57 08	8.73 77	8.85 78	8.85 89	8.95 17	8.95 34
10	7.46 37	8.30 25	8.57 42	8.74 00	8.85 95	8.86 07	8.95 31	8.95 49
11	7.50 51	8.30 88	8.57 76	8.74 23	8.86 13	8.86 24	8.95 45	8.95 63
12	7.54 29	8.31 49	8.58 09	8.74 45	8.86 30	8.86 42	8.95 59	8.95 77
13	7.57 77	8.32 11	8.58 42	8.74 68	8.86 47	8.86 59	8.95 73	8.95 91
14	7.60 98	8.32 70	8.58 75	8.74 91	8.86 64	8.86 76	8.95 87	8.96 05
15	7.63 98	8.33 29	8.59 07	8.75 13	8.86 82	8.86 93	8.96 00	8.96 19
16	7.66 78	8.33 88	8.59 39	8.75 35	8.86 99	8.87 11	8.96 14	8.96 33
17	7.69 42	8.34 45	8.59 72	8.75 57	8.87 16	8.87 28	8.96 28	8.96 46
18	7.71 90	8.35 02	8.60 03	8.75 79	8.87 32	8.87 45	8.96 42	8.96 60
19	7.74 25	8.35 58	8.60 35	8.76 01	8.87 49	8.87 62	8.96 55	8.96 74
20	7.76 48	8.36 14	8.60 66	8.76 23	8.87 66	8.87 78	8.96 69	8.96 88
21	7.78 59	8.36 69	8.60 97	8.76 45	8.87 83	8.87 95	8.96 82	8.97 01
22	7.80 61	8.37 23	8.61 28	8.76 67	8.87 99	8.88 12	8.96 96	8.97 15
23	7.82 54	8.37 75	8.61 59	8.76 88	8.88 16	8.88 29	8.97 09	8.97 29
24	7.84 39	8.38 29	8.61 89	8.77 10	8.88 33	8.88 45	8.97 23	8.97 42
25	7.86 17	8.38 81	8.62 20	8.77 31	8.88 49	8.88 62	8.97 36	8.97 56
26	7.87 87	8.39 32	8.62 50	8.77 52	8.88 65	8.88 78	8.97 50	8.97 69
27	7.89 51	8.39 83	8.62 79	8.77 73	8.88 82	8.88 95	8.97 63	8.97 82
28	7.91 09	8.40 32	8.63 09	8.77 94	8.88 98	8.89 11	8.97 76	8.97 96
29	7.92 61	8.40 83	8.63 38	8.78 15	8.89 14	8.89 27	8.97 89	8.98 09
30	7.94 08	8.41 31	8.63 68	8.78 36	8.89 30	8.89 44	8.98 03	8.98 22
		8.41 81	8.64 01	8.78 57	8.89 46	8.89 60	8.98 16	8.98 36

31	7.95 51	8.42 27	8.42 29	8.64 26	8.64 30	8.78 77	8.78 86	8.89 62	8.89 76	8.98 29	8.98 49
32	7.96 89	8.42 75	8.42 76	8.64 54	8.64 58	8.78 98	8.79 06	8.89 78	8.89 92	8.98 42	8.98 62
33	7.98 22	8.43 23	8.43 23	8.64 83	8.64 87	8.79 39	8.79 47	8.89 94	8.90 08	8.98 55	8.98 75
34	7.99 52	8.43 68	8.43 70	8.65 11	8.65 15	8.79 18	8.79 27	8.90 10	8.90 24	8.98 68	8.98 88
35	8.00 78	8.44 14	8.44 16	8.65 39	8.65 43	8.79 59	8.79 67	8.90 26	8.90 40	8.98 81	8.99 01
36	8.02 00	8.44 59	8.44 61	8.65 67	8.65 71	8.79 79	8.79 87	8.90 42	8.90 56	8.98 94	8.99 14
37	8.03 19	8.45 04	8.45 06	8.65 95	8.65 99	8.79 99	8.80 08	8.90 57	8.90 71	8.98 97	8.99 27
38	8.04 35	8.45 49	8.45 51	8.66 22	8.66 27	8.80 19	8.80 28	8.90 73	8.90 87	8.99 19	8.99 40
39	8.05 48	8.45 93	8.45 95	8.66 50	8.66 54	8.80 39	8.80 48	8.90 89	8.91 03	8.99 32	8.99 53
40	8.06 58	8.46 37	8.46 38	8.66 77	8.66 82	8.80 59	8.80 67	8.91 04	8.91 18	8.99 45	8.99 66
41	8.07 65	8.46 80	8.46 82	8.67 04	8.67 09	8.80 78	8.80 87	8.91 19	8.91 34	8.99 58	8.99 79
42	8.08 70	8.47 23	8.47 25	8.67 31	8.67 36	8.80 98	8.81 07	8.91 35	8.91 49	8.99 70	8.99 92
43	8.09 72	8.47 65	8.47 67	8.67 57	8.67 62	8.81 17	8.81 26	8.91 50	8.91 65	8.99 83	9.00 05
44	8.10 72	8.48 07	8.48 09	8.67 84	8.67 89	8.81 37	8.81 46	8.91 65	8.91 80	8.99 96	9.00 17
45	8.11 69	8.48 48	8.48 50	8.68 10	8.68 15	8.81 56	8.81 65	8.91 81	8.91 96	9.00 08	9.00 30
46	8.12 65	8.48 89	8.48 92	8.68 37	8.68 42	8.81 75	8.81 85	8.91 96	8.92 11	9.00 21	9.00 43
47	8.13 58	8.49 30	8.49 32	8.68 63	8.68 68	8.81 94	8.82 04	8.92 11	8.92 26	9.00 33	9.00 55
48	8.14 49	8.49 71	8.49 73	8.68 89	8.68 94	8.82 13	8.82 23	8.92 26	8.92 41	9.00 46	9.00 68
49	8.15 39	8.50 11	8.50 13	8.69 14	8.69 20	8.82 32	8.82 42	8.92 41	8.92 56	9.00 58	9.00 80
50	8.16 27	8.50 50	8.50 53	8.69 40	8.69 45	8.82 51	8.82 61	8.92 56	8.92 72	9.00 70	9.00 93
51	8.17 13	8.50 90	8.50 92	8.69 65	8.69 71	8.82 70	8.82 80	8.92 71	8.92 87	9.00 83	9.01 05
52	8.17 97	8.51 29	8.51 31	8.69 91	8.69 96	8.82 89	8.82 99	8.92 86	8.93 02	9.00 95	9.01 18
53	8.18 80	8.51 67	8.51 70	8.70 16	8.70 21	8.83 07	8.83 17	8.93 01	8.93 16	9.01 07	9.01 30
54	8.19 61	8.19 62	8.52 05	8.70 41	8.70 46	8.83 26	8.83 36	8.93 15	8.93 31	9.01 20	9.01 43
55	8.20 41	8.20 41	8.52 43	8.70 66	8.70 71	8.83 45	8.83 55	8.93 30	8.93 46	9.01 32	9.01 55
56	8.21 19	8.21 19	8.52 83	8.70 90	8.70 96	8.83 63	8.83 73	8.93 45	8.93 61	9.01 44	9.01 67
57	8.21 96	8.21 96	8.53 18	8.71 15	8.71 21	8.83 81	8.83 92	8.93 59	8.93 76	9.01 56	9.01 80
58	8.22 71	8.22 72	8.53 55	8.71 39	8.71 45	8.84 00	8.84 10	8.93 74	8.93 90	9.01 68	9.01 92
59	8.23 46	8.23 46	8.53 92	8.71 64	8.71 70	8.84 18	8.84 28	8.93 88	8.94 05	9.01 80	9.02 04
60	8.24 19	8.24 19	8.54 31	8.71 88	8.71 94	8.84 36	8.84 46	8.94 03	8.94 20	9.01 92	9.02 16

84°

85°

86°

87°

88°

89°

## NATURAL SINES AND COSINES

A.	Sin.	Cos.	A.	Sin.	Cos.	A.	Sin.	Cos.	A.	Sin.	Cos.
0°	.000000	1.0000	90°	30'	.1305	.9914	30'	15°	.2588	.9659	75°
10'	.002909	1.0000	50'	40'	.1334	.9911	20'	10'	.2616	.9652	50'
20'	.005818	1.0000	40'	50'	.1363	.9907	10'	20'	.2644	.9644	40'
30'	.008727	1.0000	30'	8°	.1392	.9903	82°	30'	.2672	.9636	30'
40'	.011635	.9999	20'	10'	.1421	.9899	50'	40'	.2700	.9628	20'
50'	.014544	.9999	10'	20'	.1449	.9894	40'	50'	.2728	.9621	10'
1°	.017452	.9998	89°	30'	.1478	.9890	30'	16°	.2756	.9613	74°
10'	.02036	.9998	50'	40'	.1507	.9886	20'	10'	.2784	.9605	50'
20'	.02327	.9997	40'	50'	.1536	.9881	10'	20'	.2812	.9596	40'
30'	.02618	.9997	30'	9°	.1564	.9877	81°	30'	.2840	.9588	30'
40'	.02908	.9996	20'	10'	.1593	.9872	56°	40'	.2868	.9580	20'
50'	.03199	.9995	10'	20'	.1622	.9868	40'	50'	.2896	.9572	10'
2°	.03490	.9994	88°	30'	.1650	.9863	30'	17°	.2924	.9563	73°
10'	.03781	.9993	50'	40'	.1679	.9858	20'	10'	.2952	.9555	50'
20'	.04071	.9992	40'	50'	.1708	.9853	10'	20'	.2979	.9546	40'
30'	.04362	.9990	30'	10°	.1736	.9848	80°	30'	.3007	.9537	30'
40'	.04653	.9989	20'	10'	.1765	.9843	50'	40'	.3035	.9528	20'
50'	.04943	.9988	10'	20'	.1794	.9838	40'	50'	.3062	.9520	10'
3°	.05234	.9986	87°	30'	.1822	.9833	30'	18°	.3090	.9511	72°
10'	.05524	.9985	50'	40'	.1851	.9827	20'	10'	.3118	.9502	50'
20'	.05814	.9983	40'	50'	.1880	.9822	10'	20'	.3145	.9492	40'
30'	.06105	.9981	30'	11°	.1908	.9816	79°	30'	.3173	.9483	30'
40'	.06395	.9980	20'	10'	.1937	.9811	50'	40'	.3201	.9474	20'
50'	.06685	.9978	10'	20'	.1965	.9805	40'	50'	.3228	.9465	10'
4°	.06976	.9976	86°	30'	.1994	.9799	30'	19°	.3256	.9455	71°
10'	.07266	.9974	50'	40'	.2022	.9793	20'	10'	.3283	.9446	50'
20'	.07556	.9971	40'	50'	.2051	.9787	10'	20'	.3311	.9436	40'
30'	.07846	.9969	30'	12°	.2079	.9781	78°	30'	.3338	.9426	30'
40'	.08136	.9967	20'	10'	.2108	.9775	50'	40'	.3365	.9417	20'
50'	.08426	.9964	10'	20'	.2136	.9769	40'	50'	.3393	.9407	10'
5°	.08716	.9962	85°	30'	.2164	.9763	30'	20°	.3420	.9397	70°
10'	.09005	.9959	50'	40'	.2193	.9757	20'	10'	.3448	.9387	50'
20'	.09295	.9957	40'	50'	.2221	.9750	10'	20'	.3475	.9377	40'
30'	.09585	.9954	30'	13°	.2250	.9744	77°	30'	.3502	.9367	30'
40'	.09874	.9951	20'	10'	.2278	.9737	50'	40'	.3529	.9356	20'
50'	.10164	.9948	10'	20'	.2306	.9730	40'	50'	.3557	.9346	10'
6°	.10453	.9945	84°	30'	.2334	.9724	30'	21°	.3584	.9336	69°
10'	.10742	.9942	50'	40'	.2363	.9717	20'	10'	.3611	.9325	50'
20'	.11031	.9939	40'	50'	.2391	.9710	10'	20'	.3638	.9315	40'
30'	.11320	.9936	30'	14°	.2419	.9703	76°	30'	.3665	.9304	30'
40'	.11609	.9932	20'	10'	.2447	.9696	50'	40'	.3692	.9293	20'
50'	.11898	.9929	10'	20'	.2476	.9689	40'	50'	.3719	.9283	10'
7°	.12187	.9925	83°	30'	.2504	.9681	30'	22°	.3746	.9272	68°
10'	.12476	.9922	50'	40'	.2532	.9674	20'	10'	.3773	.9261	50'
20'	.12764	.9918	40'	50'	.2560	.9667	10'	20'	.3800	.9250	40'
30'	.13053	.9914	30'	15°	.2588	.9659	75°	30'	.3827	.9239	30'
	Cos.	Sin.	A.		Cos.	Sin.	A.		Cos.	Sin.	A.

NATURAL SINES AND COSINES—continued

A.	Sin.	Cos.	A.	Sin.	Cos.	A.	Sin.	Cos.	A.	Sin.	Cos.
30'	.3827	.9239	30'	30°	.5000	.8660	60°	30'	.6088	.7934	30'
40'	.3854	.9228	20'	10'	.5025	.8646	50'	40'	.6111	.7916	20'
50'	.3881	.9216	10'	20'	.5050	.8631	40'	50'	.6134	.7898	10'
23°	.3907	.9205	67°	30'	.5075	.8616	30'	38°	.6157	.7880	52°
10'	.3934	.9194	50'	40'	.5100	.8601	20'	10'	.6180	.7862	50'
20'	.3961	.9182	40'	50'	.5125	.8587	10'	20'	.6202	.7844	40'
30'	.3987	.9171	30'	31°	.5150	.8572	59°	30'	.6225	.7826	30'
40'	.4014	.9159	20'	10'	.5175	.8557	50'	40'	.6248	.7808	20'
50'	.4041	.9147	10'	20'	.5200	.8542	40'	50'	.6271	.7790	10'
24°	.4067	.9135	66°	30'	.5225	.8526	30'	39°	.6293	.7771	51°
10'	.4094	.9124	50'	40'	.5250	.8511	20'	10'	.6316	.7753	50'
20'	.4120	.9112	40'	50'	.5275	.8496	10'	20'	.6338	.7735	40'
30'	.4147	.9100	30'	32°	.5299	.8480	58°	30'	.6361	.7716	30'
40'	.4173	.9088	20'	10'	.5324	.8465	50'	40'	.6383	.7698	20'
50'	.4200	.9075	10'	20'	.5348	.8450	40'	50'	.6406	.7679	10'
25°	.4226	.9063	65°	30'	.5373	.8434	30'	40°	.6428	.7660	50°
10'	.4253	.9051	50'	40'	.5398	.8418	20'	10'	.6450	.7642	50'
20'	.4279	.9038	40'	50'	.5422	.8403	10'	20'	.6472	.7623	40'
30'	.4305	.9026	30'	33°	.5446	.8387	57°	30'	.6494	.7604	30'
40'	.4331	.9013	20'	10'	.5471	.8371	50'	40'	.6517	.7585	20'
50'	.4358	.9001	10'	20'	.5495	.8355	40'	50'	.6539	.7566	10'
26°	.4384	.8988	64°	30'	.5519	.8339	30'	41°	.6561	.7547	49°
10'	.4410	.8975	50'	40'	.5544	.8323	20'	10'	.6583	.7528	50'
20'	.4436	.8962	40'	50'	.5568	.8307	10'	20'	.6604	.7509	40'
30'	.4462	.8949	30'	34°	.5592	.8290	56°	30'	.6626	.7490	30'
40'	.4488	.8936	20'	10'	.5616	.8274	50'	40'	.6648	.7470	20'
50'	.4514	.8923	10'	20'	.5640	.8258	40'	50'	.6670	.7451	10'
27°	.4540	.8910	63°	30'	.5664	.8241	30'	42°	.6691	.7431	48°
10'	.4566	.8897	50'	40'	.5688	.8225	20'	10'	.6713	.7412	50'
20'	.4592	.8884	40'	50'	.5712	.8208	10'	20'	.6734	.7392	40'
30'	.4617	.8870	30'	35°	.5736	.8192	55°	30'	.6756	.7373	30'
40'	.4643	.8857	20'	10'	.5760	.8175	50'	40'	.6777	.7353	20'
50'	.4669	.8843	10'	20'	.5783	.8158	40'	50'	.6799	.7333	10'
28°	.4695	.8829	62°	30'	.5807	.8141	30'	43°	.6820	.7314	47°
10'	.4720	.8816	50'	40'	.5831	.8124	20'	10'	.6841	.7294	50'
20'	.4746	.8802	40'	50'	.5854	.8107	10'	20'	.6862	.7274	40'
30'	.4772	.8788	30'	36°	.5878	.8090	54°	30'	.6884	.7254	30'
40'	.4797	.8774	20'	10'	.5901	.8073	50'	40'	.6905	.7234	20'
50'	.4823	.8760	10'	20'	.5925	.8056	40'	50'	.6926	.7214	10'
29°	.4848	.8746	61°	30'	.5948	.8039	30'	44°	.6947	.7193	46°
10'	.4874	.8732	50'	40'	.5972	.8021	20'	10'	.6967	.7173	50'
20'	.4899	.8718	40'	50'	.5995	.8004	10'	20'	.6988	.7153	40'
30'	.4924	.8704	30'	37°	.6018	.7986	53°	30'	.7009	.7133	30'
40'	.4950	.8689	20'	10'	.6041	.7969	50'	40'	.7030	.7112	20'
50'	.4975	.8675	10'	20'	.6065	.7951	40'	50'	.7050	.7092	10'
30°	.5000	.8660	60°	30'	.6088	.7934	30'	45°	.7071	.7071	45°
	Cos.	Sin.	A.		Cos.	Sin.	A.		Cos.	Sin.	A.

## NATURAL TANGENTS AND COTANGENTS

A.	Tan.	Cot.		A.	Tan.	Cot.		A.	Tan.	Cot.	
0°	.000000	∞	90°	30'	.1317	7.5958	30'	15°	.2679	3.7321	75°
10'	.002909	343.7737	50'	40'	.1346	7.4287	20'	10'	.2711	3.6891	50'
20'	.005818	171.8854	40'	50'	.1376	7.2687	10'	20'	.2742	3.6470	40'
30'	.008727	114.5887	30'	8°	.1405	7.1154	82°	30'	.2773	3.6059	30'
40'	.011636	85.9398	20'	10'	.1435	6.9682	50'	40'	.2805	3.5656	20'
50'	.014545	68.7501	10'	20'	.1465	6.8269	40'	50'	.2836	3.5261	10'
1°	.017455	57.2900	89°	30'	.1495	6.6912	30'	16°	.2867	3.4874	74°
10'	.02036	49.1039	50'	40'	.1524	6.5606	20'	10'	.2899	3.4495	50'
20'	.02328	42.9641	40'	50'	.1554	6.4348	10'	20'	.2931	3.4124	40'
30'	.02619	38.1885	30'	9°	.1584	6.3138	81°	30'	.2962	3.3759	30'
40'	.02910	34.3678	20'	10'	.1614	6.1970	50'	40'	.2994	3.3402	20'
50'	.03201	31.2416	10'	20'	.1644	6.0844	40'	50'	.3026	3.3052	10'
2°	.03492	28.6363	88°	30'	.1673	5.9758	30'	17°	.3057	3.2709	73°
10'	.03783	26.4316	50'	40'	.1703	5.8708	20'	10'	.3089	3.2371	50'
20'	.04075	24.5418	40'	50'	.1733	5.7694	10'	20'	.3121	3.2041	40'
30'	.04366	22.9038	30'	10°	.1763	5.6713	80°	30'	.3153	3.1716	30'
40'	.04658	21.4704	20'	10'	.1793	5.5764	50'	40'	.3185	3.1397	20'
50'	.04949	20.2056	10'	20'	.1823	5.4845	40'	50'	.3217	3.1084	10'
3°	.05241	19.0811	87°	30'	.1853	5.3955	30'	18°	.3249	3.0777	72°
10'	.05533	18.0750	50'	40'	.1883	5.3093	20'	10'	.3281	3.0475	50'
20'	.05824	17.1693	40'	50'	.1914	5.2257	10'	20'	.3314	3.0178	40'
30'	.06116	16.3499	30'	11°	.1944	5.1446	79°	30'	.3346	2.9887	30'
40'	.06408	15.6048	20'	10'	.1974	5.0658	50'	40'	.3378	2.9600	20'
50'	.06700	14.9244	10'	20'	.2004	4.9894	40'	50'	.3411	2.9319	10'
4°	.06993	14.3007	86°	30'	.2035	4.9152	30'	19°	.3443	2.9042	71°
10'	.07285	13.7267	50'	40'	.2065	4.8430	20'	10'	.3476	2.8770	50'
20'	.07578	13.1969	40'	50'	.2095	4.7729	10'	20'	.3508	2.8502	40'
30'	.07870	12.7062	30'	12°	.2126	4.7046	78°	30'	.3541	2.8239	30'
40'	.08163	12.2505	20'	10'	.2156	4.6382	50'	40'	.3574	2.7980	20'
50'	.08456	11.8262	10'	20'	.2186	4.5736	40'	50'	.3607	2.7725	10'
5°	.08749	11.4301	85°	30'	.2217	4.5107	30'	20°	.3640	2.7475	70°
10'	.09042	11.0594	50'	40'	.2247	4.4494	20'	10'	.3673	2.7228	50'
20'	.09335	10.7119	40'	50'	.2278	4.3897	10'	20'	.3706	2.6985	40'
30'	.09629	10.3854	30'	13°	.2309	4.3315	77°	30'	.3739	2.6746	30'
40'	.09923	10.0780	20'	10'	.2339	4.2747	50'	40'	.3772	2.6511	20'
50'	.10216	9.7882	10'	20'	.2370	4.2193	40'	50'	.3805	2.6279	10'
6°	.10510	9.5144	84°	30'	.2401	4.1653	30'	21°	.3839	2.6051	69°
10'	.10805	9.2553	50'	40'	.2432	4.1126	20'	10'	.3872	2.5826	50'
20'	.11099	9.0098	40'	50'	.2462	4.0611	10'	20'	.3906	2.5605	40'
30'	.11394	8.7769	30'	14°	.2493	4.0108	76°	30'	.3939	2.5386	30'
40'	.11688	8.5555	20'	10'	.2524	3.9617	50'	40'	.3973	2.5172	20'
50'	.11983	8.3450	10'	20'	.2555	3.9136	40'	50'	.4006	2.4960	10'
7°	.12278	8.1443	83°	30'	.2586	3.8667	30'	22°	.4040	2.4751	68°
10'	.12574	7.9530	50'	40'	.2617	3.8208	20'	10'	.4074	2.4545	50'
20'	.12869	7.7704	40'	50'	.2648	4.7760	10'	20'	.4108	2.4342	40'
30'	.13165	7.5958	30'	15°	.2679	3.7321	75°	30'	.4142	2.4142	30'
	Cot.	Tan.	A.		Cot.	Tan.	A.		Cot.	Tan.	A.

NATURAL TANGENTS AND COTANGENTS

A.	Tan.	Cot.		A.	Tan.	Cot.		A.	Tan.	Cot.	
30'	.4142	2.4142	30'	30°	.5774	1.7321	60°	30'	.7673	1.3032	30'
40'	.4176	2.3945	20'	10'	.5812	1.7205	50'	40'	.7720	1.2954	20'
50'	.4210	2.3750	10'	20'	.5851	1.7090	40'	50'	.7766	1.2876	10'
23°	.4245	2.3559	67°	30'	.5890	1.6977	30'	38°	.7813	1.2799	52°
10'	.4279	2.3369	50'	40'	.5930	1.6864	20'	10'	.7860	1.2723	50'
20'	.4314	2.3183	40'	50'	.5969	1.6753	10'	20'	.7907	1.2647	40'
30'	.4348	2.2998	30'	31°	.6009	1.6643	59°	30'	.7954	1.2572	30'
40'	.4383	2.2817	20'	10'	.6048	1.6534	50'	40'	.8002	1.2497	20'
50'	.4417	2.2637	10'	20'	.6088	1.6426	40'	50'	.8050	1.2423	10'
24°	.4452	2.2460	66°	30'	.6129	1.6319	30'	39°	.8098	1.2349	51°
10'	.4487	2.2286	50'	40'	.6168	1.6212	20'	10'	.8146	1.2276	50'
20'	.4522	2.2113	40'	50'	.6208	1.6107	10'	20'	.8195	1.2203	40'
30'	.4557	2.1943	30'	32°	.6249	1.6003	58°	30'	.8243	1.2131	30'
40'	.4592	2.1775	20'	10'	.6289	1.5900	50'	40'	.8292	1.2059	20'
50'	.4628	2.1609	10'	20'	.6330	1.5798	40'	50'	.8342	1.1988	10'
25°	.4663	2.1445	65°	30'	.6371	1.5697	30'	40°	.8391	1.1918	50°
10'	.4699	2.1283	50'	40'	.6412	1.5597	20'	10'	.8441	1.1847	50'
20'	.4734	2.1123	40'	50'	.6453	1.5497	10'	20'	.8491	1.1778	40'
30'	.4770	2.0965	30'	33°	.6494	1.5399	57°	30'	.8541	1.1708	30'
40'	.4806	2.0809	20'	10'	.6536	1.5301	50'	40'	.8591	1.1640	20'
50'	.4841	2.0655	10'	20'	.6577	1.5204	40'	50'	.8642	1.1571	10'
26°	.4877	2.0503	64°	30'	.6619	1.5108	30'	41°	.8693	1.1504	49°
10'	.4913	2.0353	50'	40'	.6661	1.5013	20'	10'	.8744	1.1436	50'
20'	.4950	2.0204	40'	50'	.6703	1.4919	10'	20'	.8796	1.1369	40'
30'	.4986	2.0057	30'	34°	.6745	1.4826	56°	30'	.8847	1.1303	30'
40'	.5022	1.9912	20'	10'	.6787	1.4733	50'	40'	.8899	1.1237	20'
50'	.5059	1.9768	10'	20'	.6830	1.4641	40'	50'	.8952	1.1171	10'
27°	.5095	1.9626	63°	30'	.6873	1.4550	30'	42°	.9004	1.1106	48°
10'	.5132	1.9486	50'	40'	.6916	1.4460	20'	10'	.9057	1.1041	50'
20'	.5169	1.9347	40'	50'	.6959	1.4370	10'	20'	.9110	1.0977	40'
30'	.5206	1.9210	30'	35°	.7002	1.4281	55°	30'	.9163	1.0913	30'
40'	.5243	1.9074	20'	10'	.7046	1.4193	50'	40'	.9217	1.0850	20'
50'	.5280	1.8940	10'	20'	.7089	1.4106	40'	50'	.9271	1.0786	10'
28°	.5317	1.8807	62°	30'	.7133	1.4019	30'	43°	.9325	1.0724	47°
10'	.5354	1.8676	50'	40'	.7177	1.3934	20'	10'	.9380	1.0661	50'
20'	.5392	1.8546	40'	50'	.7221	1.3848	10'	20'	.9435	1.0599	40'
30'	.5430	1.8418	30'	36°	.7265	1.3764	54°	30'	.9490	1.0538	30'
40'	.5467	1.8291	20'	10'	.7310	1.3680	50'	40'	.9545	1.0477	20'
50'	.5505	1.8165	10'	20'	.7355	1.3597	40'	50'	.9601	1.0416	10'
29°	.5543	1.8040	61°	30'	.7400	1.3514	30'	44°	.9657	1.0355	46°
10'	.5581	1.7917	50'	40'	.7445	1.3432	20'	10'	.9713	1.0295	50'
20'	.5619	1.7796	40'	50'	.7490	1.3351	10'	20'	.9770	1.0235	40'
30'	.5658	1.7675	30'	37°	.7536	1.3270	53°	30'	.9827	1.0176	30'
40'	.5696	1.7556	20'	10'	.7581	1.3190	50'	40'	.9884	1.0117	20'
50'	.5735	1.7437	10'	20'	.7627	1.3111	40'	50'	.9942	1.0058	10'
30°	.5774	1.7321	60°	30'	.7673	1.3032	30'	45°	1.0000	1.0000	45°
	Cot.	Tan.	A.		Cot.	Tan.	A.		Cot.	Tan.	A.

*abcdefghijklmnopqrstuvwxyz*  
*ABCDEFGHIJKLMNOPQRSTUVWXYZ*  
*1234567890 & I II III IV V VI VII VIII etc.*

*Inclined Lettering, Used for Waters.*

*abcdefghijklmnopqrstuvwxyz*  
*ABCDEFGHIJKLMNOPQRSTUVWXYZ*  
*Condensed Style. & 1234567890 Extended*

*Upright Lettering, for General Use.*

LETTERING SUGGESTED FOR USE ON A WOODSMAN'S MAP

## SECTION II

### TABLES RELATING TO PARTS III AND IV

1.	VOLUMES OF CYLINDERS (LOGS) IN CUBIC FEET . . . . .	236
2.	AREAS OF CIRCLES OR BASAL AREAS . . . . .	238
3.	CORD WOOD RULE . . . . .	239
4.	NEW HAMPSHIRE RULE . . . . .	240
5.	NEW YORK STANDARD RULE . . . . .	242
6.	SCRIBNER LOG RULE, LEGAL IN MINNESOTA . . . . .	243
7.	DECIMAL RULE OF THE U. S. FOREST SERVICE . . . . .	244
8.	DOYLE RULE . . . . .	246
9.	MAINE LOG RULE . . . . .	248
10.	QUEBEC RULE . . . . .	250
11.	NEW BRUNSWICK RULE . . . . .	253
12.	CLARK'S INTERNATIONAL RULE . . . . .	254
13.	SPAULDING RULE OF COLUMBIA RIVER . . . . .	255
14.	BRITISH COLUMBIA RULE . . . . .	258
15.	VOLUME TABLES	
	<i>A. Eastern</i>	
1.	White Pine by the Scribner Rule . . . . .	261
2, 3.	Red (Norway) Pine by the Scribner Rule . . . . .	262
4.	White Pine as sawed in Massachusetts . . . . .	263
5.	White Pine in Cords . . . . .	264
6.	Spruce in Cubic Feet . . . . .	264
7.	Spruce in Feet, Board Measure . . . . .	265
8.	Spruce in Cords . . . . .	266
9.	Hemlock by the Scribner Rule . . . . .	267
10.	Hemlock as sawed in New Hampshire . . . . .	268
11.	White (paper) Birch in Cords . . . . .	268
12.	Red Oak as sawed in New Hampshire . . . . .	269
13.	Peeled Poplar in Cords . . . . .	270
14.	Second Growth Hard Woods in Cords . . . . .	270
15.	Form Height Factors for Southern Hard Woods . . . . .	271
16, 17.	Northern Hard Woods in Board Measure . . . . .	272, 273
18.	Longleaf Pine in Board Measure . . . . .	274
19.	Loblolly Pine by the Scribner Rule . . . . .	275
	<i>B. Western; Notes on Western Volume Tables</i>	276
20.	Western White Pine in Board Feet . . . . .	281
21.	Western Yellow Pine in Board Feet . . . . .	282
22.	Western Yellow Pine (16-foot log lengths) . . . . .	283
23.	Lodgepole Pine in Feet, Board Measure, and in Railroad Ties . . . . .	284
24.	Western Larch in Board Measure . . . . .	285
25.	Engelmann Spruce in Board Measure . . . . .	286
26.	Douglas Fir of the Coast . . . . .	287
27.	Douglas Fir of the Interior . . . . .	288
28.	Washington Hemlock in Board Measure . . . . .	289
29.	Washington Red Cedar in Board Measure . . . . .	290
30.	California Sugar Pine in Board Measure . . . . .	292

# CONTENTS OF CYLINDERS IN CUBIC FEET

(Gives also area of any number of circles)

Length In Feet	Diameter in Inches																								
	3	4	5	6	7	8	9	10	11	12	13	14	15	16	17	18	19	20	21	22	23	24	25		
1	.05	.09	0.14	0.20	0.27	0.35	0.44	0.55	0.66	0.79	0.92	1.1	1.2	1.4	1.6	1.8	2.0	2.2	2.4	2.6	2.9	3.1	3.4		
2	.10	.17	0.27	0.39	0.53	0.70	0.88	1.09	1.32	1.57	1.84	2.1	2.4	2.8	3.1	3.5	3.9	4.4	4.8	5.3	5.8	6.3	6.8		
3	.15	.26	0.41	0.59	0.80	1.05	1.33	1.64	1.98	2.36	2.77	3.2	3.7	4.2	4.7	5.3	5.9	6.5	7.2	7.9	8.7	9.4	10.2		
4	.20	.35	0.55	0.79	1.07	1.40	1.77	2.18	2.64	3.14	3.69	4.3	4.9	5.6	6.3	7.1	7.9	8.7	9.6	10.6	11.5	12.6	13.6		
5	.25	.44	0.68	0.98	1.34	1.75	2.21	2.73	3.30	3.93	4.61	5.3	6.1	7.0	7.9	8.8	9.8	10.9	12.0	13.2	14.4	15.7	17.0		
6	.29	.52	0.82	1.18	1.60	2.09	2.65	3.27	3.96	4.71	5.53	6.4	7.4	8.4	9.5	10.6	11.8	13.1	14.4	15.8	17.3	18.8	20.4		
7	.34	.61	0.95	1.37	1.87	2.44	3.09	3.82	4.62	5.50	6.45	7.5	8.6	9.8	11.0	12.4	13.8	15.3	16.8	18.5	20.2	22.0	23.9		
8	.39	.70	1.09	1.57	2.14	2.79	3.53	4.36	5.28	6.28	7.37	8.5	9.8	11.2	12.6	14.1	15.7	17.4	19.2	21.1	23.1	25.1	27.3		
9	.44	.79	1.23	1.77	2.41	3.14	3.98	4.91	5.94	7.07	8.30	9.6	11.0	12.6	14.2	15.9	17.7	19.6	21.6	23.8	26.0	28.3	30.7		
10	.49	.87	1.36	1.96	2.67	3.49	4.42	5.45	6.60	7.85	9.22	10.7	12.3	14.0	15.8	17.7	19.7	21.8	24.1	26.4	28.8	31.4	34.1		
20	1.0	1.7	2.7	3.9	5.3	7.0	8.8	11.	13.	16.	18.	21.	24.	28.	31.	35.	39.	44.	48.	53.	58.	63.	68.		
30	1.5	2.6	4.1	5.9	8.	10.	13.	16.	20.	24.	28.	32.	37.	42.	47.	53.	59.	65.	72.	79.	87.	94.	102.		
40	2.0	3.5	5.5	7.9	11.	14.	18.	22.	26.	31.	37.	43.	49.	56.	63.	71.	79.	87.	96.	106.	115.	126.	136.		
50	2.5	4.4	6.8	9.8	13.	17.	22.	27.	33.	39.	46.	53.	61.	70.	79.	88.	98.	109.	120.	132.	144.	157.	170.		
60	2.9	5.2	8.2	12.	16.	21.	26.	33.	40.	47.	55.	64.	74.	84.	95.	106.	118.	131.	144.	158.	173.	188.	204.		
70	3.4	6.1	9.5	14.	19.	24.	31.	38.	46.	55.	65.	75.	86.	98.	110.	124.	138.	153.	168.	185.	202.	220.	239.		
80	3.9	7.0	11.	16.	21.	28.	35.	44.	53.	63.	74.	85.	98.	112.	126.	141.	157.	174.	192.	211.	231.	251.	272.		
90	4.4	7.9	12.	18.	24.	31.	40.	49.	59.	71.	83.	96.	110.	126.	142.	159.	177.	196.	216.	238.	260.	283.	307.		

*Example.* A log 47 ft. long has a mid diameter of 17 inches. Contents of cylinder 7 ft. long is found in the table under 17 inches to be 11 cu. ft. Cylinder 40 ft. long of same diameter has 63 cu. ft. contents.  $63 + 11 = 74$  cu. ft. total contents of log.

CONTENTS OF CYLINDERS IN CUBIC FEET (continued)

(Gives also area of any number of circles)

Length in Feet	Diameter in Inches																						
	26	27	28	29	30	31	32	33	34	35	36	37	38	39	40	41	42	43	44	45	46	47	48
1	3.7	4.0	4.3	4.6	4.9	5.2	5.6	5.9	6.3	6.7	7.1	7.5	7.9	8.3	8.7	9.2	9.6	10	11	11	12	12	13
2	7.4	7.9	8.5	9.2	9.8	10.5	11.2	11.9	12.6	13.4	14.1	14.9	15.7	16.6	17.5	18.3	19.2	20	21	22	23	24	25
3	11.1	11.9	12.8	13.8	14.7	15.7	16.8	17.8	18.9	20.0	21.2	22.4	23.6	24.9	26.2	27.5	28.9	30	32	33	35	36	38
4	14.7	15.9	17.1	18.4	19.6	21.0	22.3	23.8	25.2	26.7	28.3	29.9	31.5	33.2	34.9	36.7	38.8	40	42	44	46	48	50
5	18.4	19.9	21.4	22.9	24.5	26.2	27.9	29.7	31.5	33.4	35.3	37.3	39.4	41.5	43.6	45.8	48.1	50	53	55	58	60	63
6	22.1	23.9	25.7	27.5	29.4	31.4	33.5	35.6	37.8	40.1	42.4	44.8	47.3	49.8	52.4	55.0	57.7	60	63	66	69	72	75
7	25.8	27.8	29.9	32.1	34.4	36.7	39.1	41.6	44.1	46.8	49.5	52.3	55.1	58.1	61.1	64.2	67.3	71	74	77	81	84	88
8	29.5	31.8	34.2	36.7	39.3	41.9	44.7	47.5	50.4	53.4	56.5	59.7	63.0	66.4	69.8	73.3	77.0	81	84	88	92	96	101
9	33.2	35.8	38.5	41.3	44.2	47.2	50.3	53.5	56.7	60.1	63.6	67.2	70.9	74.7	78.5	82.5	86.6	91	95	99	104	108	113
10	36.9	39.8	42.8	45.6	49.1	52.4	55.9	59.4	63.0	66.8	70.7	74.7	78.8	83.0	87.3	91.7	96.2	101	106	110	115	120	126
20	74	79	85	92	98	105	112	119	126	134	141	149	157	166	175	183	192	202	211	221	231	241	251
30	111	119	128	138	147	157	168	178	189	200	212	224	236	249	262	275	289	302	317	331	346	361	377
40	147	159	171	184	196	210	223	238	252	267	283	299	315	332	349	367	385	403	422	442	461	482	503
50	184	199	214	229	245	262	279	297	315	334	353	373	394	415	436	458	481	504	528	552	577	602	628
60	221	239	257	275	294	314	335	356	378	401	424	448	473	498	524	550	577	605	634	663	692	723	754
70	258	278	299	321	344	367	391	416	441	468	495	523	551	581	611	642	673	706	739	773	808	843	880
80	295	318	342	367	393	419	447	475	504	534	565	597	630	664	698	733	770	806	845	884	923	964	1006
90	332	358	385	413	442	472	503	535	567	601	636	672	709	747	785	825	866	907	950	994	1039	1084	1131

*Example.* In calipering over a piece of timber 23 trees are found whose diameter is 13 inches at breast high. What is the area of the cross section of these trees taken together, or, in other words, the total basal area?  
 In the column under 13 inches and opposite 20 in the column marked "Length in Feet" 18 is found. In the same column opposite 3 feet is 2.77.  $18 + 2.77 = 20.77$ , or with sufficient accuracy for this purpose 21. 21 square feet, therefore, is the answer desired.

## AREA OF CIRCLES OR BASAL AREAS

(Gives also Contents of Cylinders one foot long)

Diameter Inches	Area Sq. ft.	Diameter Inches	Area Sq. ft.	Diameter Inches	Area Sq. ft.	Diameter Inches	Area Sq. ft.	Diameter Inches	Area Sq. ft.
1.0	.005	13.0	0.92	25.0	3.41	37.0	7.47	49.0	13.10
1.5	.012	13.5	0.99	25.5	3.55	37.5	7.67	49.5	13.37
2.0	.022	14.0	1.07	26.0	3.69	38.0	7.88	50.0	13.64
2.5	.034	14.5	1.15	26.5	3.83	38.5	8.08	50.5	13.91
3.0	.049	15.0	1.23	27.0	3.98	39.0	8.30	51.0	14.19
3.5	.067	15.5	1.31	27.5	4.12	39.5	8.51	51.5	14.47
4.0	.087	16.0	1.40	28.0	4.28	40.0	8.73	52.0	14.75
4.5	.111	16.5	1.48	28.5	4.43	40.5	8.95	52.5	15.03
5.0	.136	17.0	1.58	29.0	4.59	41.0	9.17	53.0	15.32
5.5	.165	17.5	1.67	29.5	4.75	41.5	9.39	53.5	15.59
6.0	.196	18.0	1.77	30.0	4.91	42.0	9.62	54.0	15.90
6.5	.230	18.5	1.87	30.5	5.07	42.5	9.85	54.5	16.20
7.0	.267	19.0	1.97	31.0	5.24	43.0	10.08	55.0	16.50
7.5	.307	19.5	2.07	31.5	5.41	43.5	10.32	55.5	16.80
8.0	.349	20.0	2.18	32.0	5.59	44.0	10.56	56.0	17.10
8.5	.394	20.5	2.29	32.5	5.76	44.5	10.80	56.5	17.41
9.0	.442	21.0	2.41	33.0	5.94	45.0	11.04	57.0	17.72
9.5	.492	21.5	2.52	33.5	6.12	45.5	11.29	57.5	18.03
10.0	.545	22.0	2.64	34.0	6.30	46.0	11.54	58.0	18.35
10.5	.601	22.5	2.76	34.5	6.49	46.5	11.79	58.5	18.67
11.0	.660	23.0	2.89	35.0	6.68	47.0	12.05	59.5	18.99
11.5	.721	23.5	3.01	35.5	6.87	47.5	12.26	59.5	19.31
12.0	.785	24.0	3.14	36.0	7.07	48.0	12.57	60.0	19.63
12.5	.852	24.5	3.27	36.5	7.27	48.5	12.83	60.5	19.96

STACKED CUBIC FEET IN LOGS OF GIVEN DIMENSIONS, 128 MAKE A CORD (see page 130)

True to nearest tenth up to 10 cu. ft., above that to nearest foot

Feet in Length	Diameter at Middle—Inches																		
	3	4	5	6	7	8	9	10	11	12	13	14	15	16	17	18	19	20	
4	0.2	0.4	0.7	1.0	1.4	1.8	2.3	2.8	3.4	4	4.7	5.4	6.2	7.1	8	9	10	11	
8	0.5	0.9	1.4	2.0	2.7	3.5	4.5	5.5	6.7	8	9.4	11	12	14	16	18	20	22	25
10	0.6	1.1	1.7	2.5	3.4	4.4	5.6	6.9	8.4	10	12	14	16	18	20	22	25	28	33
12	0.7	1.3	2.1	3.0	4.1	5.3	6.8	8.3	10	12	14	16	19	21	24	27	30	33	36
13	0.8	1.4	2.2	3.2	4.4	5.8	7.3	9	11	13	15	18	20	23	26	29	33	36	40
16	1.0	1.8	2.8	4.0	5.5	7.1	9	11	13	16	19	22	25	28	32	36	40	44	56
20	..	2.2	3.5	5.0	6.8	8.9	11	14	17	20	23	27	31	36	40	45	50	56	64
21	..	2.3	3.6	5.2	7.2	9.3	12	15	18	21	25	29	33	37	42	47	52	59	61
22	..	2.4	3.8	5.5	7.5	9.8	12	15	18	22	26	30	34	39	44	49	55	61	64
23	..	2.6	4.0	5.8	7.8	10	13	16	19	23	27	31	36	41	46	52	58	64	67
24	..	2.7	4.2	6.0	8.2	11	14	17	20	24	28	33	38	43	48	54	60	67	70
25	..	2.8	4.3	6.2	8.5	11	15	18	21	25	29	34	39	44	50	56	63	70	73
26	..	2.9	4.5	6.5	8.8	11	15	19	22	26	31	35	41	46	52	59	65	73	75
27	..	3.0	4.7	6.8	9.2	12	16	19	23	27	32	37	42	48	54	61	68	75	78
28	..	..	4.8	7.0	9.5	12	16	19	23	28	33	38	44	50	56	63	70	78	81
29	..	..	5.0	7.2	9.9	13	17	20	24	29	34	39	45	52	58	65	73	81	83
30	..	..	5.2	7.5	10	13	17	21	25	30	35	41	47	53	60	67	75	83	86
31	..	..	..	7.8	11	14	18	22	26	31	36	42	48	55	62	70	78	86	89
32	..	..	..	8.0	11	14	18	22	27	32	38	44	50	57	64	72	80	89	92
33	..	..	..	8.2	11	15	19	23	28	33	39	45	51	59	66	74	83	92	94
34	..	..	..	8.5	12	15	19	24	29	34	40	46	53	60	68	76	85	94	94
35	..	..	..	8.8	12	16	20	24	29	35	41	47	55	62	70	79	87	97	100
36	..	..	..	9.0	12	16	20	25	30	36	42	48	56	64	72	81	90	90	100
37	..	..	..	9.2	13	16	21	26	31	37	43	50	58	66	74	83	93	93	103
38	..	..	..	9.5	13	17	21	26	32	38	45	52	59	68	76	86	95	95	105
39	..	..	..	9.8	13	17	22	27	33	39	46	53	61	69	78	88	98	98	108
40	..	..	..	10.0	14	18	23	28	34	40	47	54	62	71	80	90	100	100	111

## LOG CONTENTS BY NEW HAMPSHIRE RULE

Feet in Length	Inches in Diameter																						
	4	5	6	7	8	9	10	11	12	13	14	15	16	17	18	19	20	21	22	23	24	25	
12	..	1	..	..	3	..	..	..	7	8	9	11	12	15	15	..	..	21	25	25	27	29	29
13	..	..	..	..	..	..	..	..	..	..	10	11	13	13	..	..	..	..	..	..	..	29	34
14	..	..	..	3	..	..	..	..	..	..	11	12	14	..	..	..	..	..	..	31	..	..	..
15	1	..	..	..	..	..	..	..	..	..	12	13	15	..	..	..	..	..	..	31	36	39	39
16	..	..	..	..	..	..	..	..	..	..	13	14	16	..	..	..	..	..	..	35	40	44	44
17	..	..	..	..	..	..	..	..	10	12	14	16	17	20	..	..	..	..	..	39	45	49	49
18	..	..	..	..	..	..	..	..	11	13	15	18	20	25	..	..	..	..	..	40	45	49	49
19	..	..	..	..	..	..	..	..	12	14	17	19	21	25	..	..	..	..	..	40	45	49	49
20	..	..	..	..	..	..	..	..	13	15	18	20	22	25	..	..	..	..	..	40	45	49	49
21	..	..	..	..	..	..	..	..	14	16	19	21	23	25	..	..	..	..	..	40	45	49	49
22	..	..	..	..	..	..	..	..	15	17	20	22	24	25	..	..	..	..	..	45	50	56	56
23	..	..	..	..	..	..	..	..	16	18	21	23	25	28	..	..	..	..	..	45	50	56	56
24	..	..	..	..	..	..	..	..	17	19	22	24	26	29	..	..	..	..	..	49	56	61	61
25	..	..	..	..	..	..	..	..	18	20	23	25	27	30	..	..	..	..	..	56	63	66	66
26	..	..	..	..	..	..	..	..	19	21	24	26	28	31	..	..	..	..	..	56	63	66	66
27	..	..	..	..	..	..	..	..	20	22	25	27	29	32	..	..	..	..	..	60	65	71	71
28	..	..	..	..	..	..	..	..	21	23	26	28	30	33	..	..	..	..	..	60	65	71	71
29	..	..	..	..	..	..	..	..	22	24	27	29	31	34	..	..	..	..	..	64	65	71	71
30	..	..	..	..	..	..	..	..	23	25	28	30	32	35	..	..	..	..	..	64	65	71	71
31	..	..	..	..	..	..	..	..	24	26	29	31	33	36	..	..	..	..	..	64	65	71	71
32	..	..	..	..	..	..	..	..	25	27	30	32	34	37	..	..	..	..	..	64	65	71	71
33	..	..	..	..	..	..	..	..	26	28	31	33	35	38	..	..	..	..	..	64	65	71	71
34	..	..	..	..	..	..	..	..	27	29	32	34	36	39	..	..	..	..	..	64	65	71	71
35	..	..	..	..	..	..	..	..	28	30	33	35	37	40	..	..	..	..	..	64	65	71	71
36	..	..	..	..	..	..	..	..	29	31	34	36	38	41	..	..	..	..	..	64	65	71	71
37	..	..	..	..	..	..	..	..	30	32	35	37	39	42	..	..	..	..	..	64	65	71	71
38	..	..	..	..	..	..	..	..	31	33	36	38	40	43	..	..	..	..	..	64	65	71	71
39	..	..	..	..	..	..	..	..	32	34	37	39	41	44	..	..	..	..	..	64	65	71	71
40	..	..	..	..	..	..	..	..	33	35	38	40	42	45	..	..	..	..	..	64	65	71	71

LOG CONTENTS BY NEW HAMPSHIRE RULE (continued)

Feet in Length	Inches in Diameter														
	26	27	28	29	30	31	32	33	34	35	36	37	38	39	40
12	32	34	37	39	42	45	48	51	54.0	57	61	64	68	70	75
13	37	37	40	43	46	49	52	55	58.0	62	66	69	73	80	81
14	37	40	43	46	49	53	56	60	63.0	67	71	75	79	87	87
15	..	43	46	49	53	56	60	64	68.0	72	76	80	85	90	94
16	..	46	49	53	56	60	64	68	72.0	77	81	85	90	96	100
17	45	48	52	56	60	64	68	72	77.0	81	86	91	96	101	106
18	..	51	55	59	63	68	72	77	81.0	86	91	96	101	107	112
19	50	54	58	62	67	71	76	81	86.0	91	96	101	107	113	119
20	..	57	61	66	70	75	80	85	90.0	96	101	107	113	119	125
21	..	60	64	69	74	79	84	89	95.0	100	106	112	118	125	131
22	58	63	67	72	77	83	88	94	99.0	105	111	118	124	131	137
23	..	65	70	76	81	86	92	98	104.0	110	116	123	130	137	144
24	..	68	74	79	84	90	96	102	108.0	115	121	128	135	142	150
25	66	71	77	82	88	94	100	106	113.0	120	126	134	141	148	156
26	..	74	80	85	91	98	104	111	117.0	125	132	139	147	154	162
27	..	77	83	89	95	101	108	115	122.0	129	137	144	152	160	169
28	74	80	86	92	98	105	112	119	126.0	134	142	150	158	166	175
29	..	83	89	95	102	109	116	123	131.0	139	147	155	163	172	181
30	..	85	92	99	105	113	120	128	135.0	144	152	160	169	178	187
31	82	88	95	102	109	116	124	132	140.0	148	157	166	175	184	194
32	..	91	98	105	112	120	128	136	145.0	153	162	171	180	190	200
33	..	94	101	108	116	124	132	140	149.0	158	167	177	186	196	206
34	90	97	104	112	119	128	136	145	154.0	163	172	182	192	202	212
35	95	100	107	115	123	131	140	149	158.0	167	177	187	197	208	219
36	..	102	110	118	126	135	144	153	162.5	172	182	192	203	214	225
37	..	105	113	122	130	139	148	157	167.0	177	187	198	208	220	231
38	100	108	116	125	133	143	152	162	172.0	182	192	203	214	226	237
39	..	111	120	128	137	146	156	166	176.0	187	197	208	220	232	244
40	106	114	123	131	140	150	160	170	181.0	191	202	214	226	238	250

NEW YORK STANDARD, DIMICK, OR  
GLENN'S FALLS RULE

LENGTH	DIAMETER IN INCHES													
	3	4	5	6	7	8	9	10	11	12	13	14	15	
ft.														
4	.009	.01	.02	.03	.04	.06	.07	.09	.10	.12	.14	.17	.19	
5	.01	.02	.03	.04	.05	.07	.08	.11	.13	.15	.18	.21	.24	
6	.01	.02	.03	.05	.06	.08	.10	.13	.16	.18	.22	.25	.29	
7	.02	.02	.04	.05	.08	.10	.12	.15	.18	.22	.25	.29	.33	
8	.02	.02	.04	.06	.09	.11	.14	.17	.21	.25	.29	.33	.38	
9	.02	.03	.05	.07	.10	.12	.15	.19	.24	.28	.33	.37	.43	
10	.02	.03	.05	.08	.11	.14	.17	.22	.26	.31	.36	.42	.48	
11	.03	.03	.06	.08	.12	.15	.19	.24	.29	.34	.40	.46	.52	
12	.03	.04	.06	.09	.13	.17	.20	.26	.31	.37	.43	.50	.57	
13	.03	.04	.07	.10	.14	.18	.22	.28	.34	.40	.47	.54	.62	
	16	17	18	19	20	21	22	23	24	25	26	27	28	
4	.22	.25	.28	.31	.34	.38	.41	.45	.49	.53	.58	.62	.67	
5	.27	.31	.35	.38	.43	.47	.52	.57	.62	.67	.72	.78	.83	
6	.33	.37	.42	.46	.51	.56	.62	.68	.74	.80	.86	.93	1.00	
7	.38	.43	.48	.54	.60	.66	.72	.79	.86	.93	1.01	1.09	1.17	
8	.44	.49	.55	.62	.68	.75	.82	.90	.98	1.06	1.15	1.24	1.34	
9	.49	.55	.62	.69	.77	.84	.93	1.02	1.11	1.20	1.29	1.40	1.50	
10	.55	.62	.69	.77	.85	.94	1.03	1.13	1.23	1.33	1.44	1.55	1.67	
11	.60	.68	.76	.85	.94	1.03	1.13	1.24	1.35	1.46	1.58	1.71	1.84	
12	.66	.74	.83	.92	1.02	1.13	1.24	1.36	1.48	1.60	1.73	1.86	2.00	
13	.71	.80	.90	1.00	1.11	1.22	1.34	1.47	1.60	1.73	1.87	2.02	2.17	
	29	30	31	32	33	34	35	36	37	38	39	40		
4	.72	.77	.82	.87	.93	.98	1.04	1.10	1.17	1.23	1.30	1.36		
5	.90	.96	1.02	1.09	1.16	1.23	1.30	1.38	1.46	1.54	1.62	1.70		
6	1.08	1.15	1.23	1.31	1.39	1.48	1.56	1.66	1.75	1.85	1.94	2.04		
7	1.25	1.34	1.43	1.53	1.63	1.72	1.83	1.93	2.04	2.15	2.27	2.39		
8	1.43	1.53	1.64	1.75	1.86	1.97	2.09	2.21	2.33	2.46	2.59	2.73		
9	1.61	1.72	1.84	1.97	2.09	2.22	2.35	2.49	2.62	2.77	2.91	3.07		
10	1.79	1.92	2.05	2.18	2.32	2.46	2.61	2.76	2.92	3.08	3.24	3.41		
11	1.97	2.11	2.25	2.40	2.56	2.71	2.87	3.04	3.21	3.38	3.56	3.75		
12	2.15	2.30	2.46	2.62	2.79	2.95	3.13	3.31	3.50	3.69	3.89	4.09		
13	2.33	2.49	2.66	2.84	3.02	3.20	3.39	3.59	3.79	4.00	4.21	4.43		

SCRIBNER LOG RULE

Legal Rule in Minnesota

Length in Feet		Diameter Inches																					
		6	7	8	9	10	11	12	13	14	15	16	17	18	19	20	21	22	23	24	25	26	27
12	18	24	30	40	50	59	73	86	107	119	139	160	180	210	228	251	283	303	344	375	411	436	457
14	24	28	35	45	55	69	85	100	125	139	162	187	210	245	266	292	330	353	401	439	479	509	533
16	18	28	32	40	50	65	79	114	142	159	185	213	240	280	304	334	377	404	459	500	548	582	609
18	22	32	40	45	55	70	88	109	129	160	178	208	240	270	315	342	376	424	454	516	562	616	654
20	24	34	44	50	65	80	122	143	178	198	232	267	300	350	380	418	470	505	573	625	684	728	761
22	28	38	48	55	70	90	108	134	157	196	218	255	293	330	385	418	460	518	631	688	753	800	838
24						118	146	172	214	238	278	320	360	420	456	501	566	606	688	750	821	873	914

Length in Feet		Diameter Inches																		
		30	31	32	33	34	35	36	37	38	39	40	41	42	43	44	45	46	47	48
12	493	532	552	588	600	657	692	772	801	840	903	954	1007	1046	1110	1139	1190	1242	1296	
14	575	622	644	686	700	766	807	901	934	980	1053	1113	1175	1222	1295	1329	1388	1449	1512	
16	657	710	736	784	800	876	923	1029	1068	1120	1204	1272	1343	1396	1480	1518	1587	1656	1728	
18	739	799	828	882	900	985	1038	1158	1201	1260	1354	1431	1511	1571	1665	1707	1785	1862	1944	
20	821	888	920	980	1000	1095	1152	1287	1335	1400	1505	1590	1679	1745	1850	1898	1983	2070	2160	
22	904	976	1012	1078	1100	1204	1268	1416	1468	1540	1656	1748	1848	1918	2034	2088	2180	2276	2376	
24	986	1065	1104	1176	1200	1314	1380	1544	1602	1680	1806	1908	2014	2092	2220	2278	2380	2484	2592	



Length in Feet	Diameter Inches																					
	51	52	53	54	55	56	57	58	59	60	61	62	63	64	65	66	67	68	69	70	71	72
8	97	101	105	109	113	118	122	126	131	135	140	145	149	154	159	164	170	175	180	186	192	197
10	122	127	132	137	142	147	152	158	163	169	175	181	187	193	199	206	212	219	226	232	240	247
12	146	152	158	164	170	176	183	189	196	203	210	217	224	232	239	247	254	262	271	279	287	296
14	170	177	184	191	198	206	213	221	229	237	245	253	261	270	279	288	297	306	316	325	335	345
16	195	202	210	218	227	235	244	252	261	270	280	289	299	309	319	329	339	350	361	372	383	395
18	219	228	237	246	255	264	274	284	294	304	315	325	336	348	358	370	381	393	406	419	430	444
20	243	253	263	273	283	294	304	315	327	338	350	362	373	387	398	412	423	437	452	465	478	493
22	268	278	289	300	312	323	335	347	359	372	385	398	411	425	438	453	466	480	497	512	526	543
24	292	304	316	328	340	353	365	379	392	406	420	434	448	464	478	494	508	524	542	558	574	592
26	315	329	341	355	368	382	396	410	425	439	455	470	485	503	518	535	550	568	587	605	622	641
28	341	354	368	382	397	411	426	442	457	473	490	506	523	541	558	576	593	611	632	651	670	691
30	365	380	395	410	425	441	457	473	490	507	525	542	560	580	597	617	635	655	677	698	717	740
32	389	405	421	437	453	470	487	505	523	541	560	579	597	619	637	659	677	699	723	744	765	789
73	203	209	215	221	228	234	240	247	254	261	268	275	281	288	295	301	308	315	321	328	335	342
74	209	215	221	228	234	240	247	254	261	268	275	281	288	295	301	308	315	321	328	335	342	349
75	215	221	228	234	240	247	254	261	268	275	281	288	295	301	308	315	321	328	335	342	349	356
76	221	228	234	240	247	254	261	268	275	281	288	295	301	308	315	321	328	335	342	349	356	363
77	228	234	240	247	254	261	268	275	281	288	295	301	308	315	321	328	335	342	349	356	363	370
78	234	240	247	254	261	268	275	281	288	295	301	308	315	321	328	335	342	349	356	363	370	377
79	240	247	254	261	268	275	281	288	295	301	308	315	321	328	335	342	349	356	363	370	377	384
80	247	254	261	268	275	281	288	295	301	308	315	321	328	335	342	349	356	363	370	377	384	391
81	254	261	268	275	281	288	295	301	308	315	321	328	335	342	349	356	363	370	377	384	391	398
82	261	268	275	281	288	295	301	308	315	321	328	335	342	349	356	363	370	377	384	391	398	405
83	268	275	281	288	295	301	308	315	321	328	335	342	349	356	363	370	377	384	391	398	405	412
84	275	281	288	295	301	308	315	321	328	335	342	349	356	363	370	377	384	391	398	405	412	419
85	281	288	295	301	308	315	321	328	335	342	349	356	363	370	377	384	391	398	405	412	419	426
86	287	295	301	308	315	321	328	335	342	349	356	363	370	377	384	391	398	405	412	419	426	433
87	295	301	308	315	321	328	335	342	349	356	363	370	377	384	391	398	405	412	419	426	433	440
88	301	308	315	321	328	335	342	349	356	363	370	377	384	391	398	405	412	419	426	433	440	447
89	308	315	321	328	335	342	349	356	363	370	377	384	391	398	405	412	419	426	433	440	447	454
90	315	321	328	335	342	349	356	363	370	377	384	391	398	405	412	419	426	433	440	447	454	461

DOYLE RULE

Length in Feet	Diameter in Inches																Length in Feet		
	8	9	10	11	12	13	14	15	16	17	18	19	20	21	22	23		24	25
8	12	18	24	32	40	50	60	72	84	98	112	128	144	162	180	200	220	242	262
9	14	20	28	36	46	56	68	81	95	110	127	144	163	182	203	225	248	272	298
10	16	23	31	40	50	62	75	90	106	122	141	160	181	202	226	250	276	302	330
11	17	25	34	44	55	69	83	99	116	135	155	176	199	223	248	275	303	334	363
12	19	27	37	48	61	75	91	108	127	147	169	192	217	243	271	300	331	363	393
13	20	29	40	52	66	81	98	117	137	159	183	208	235	263	293	325	358	393	423
14	22	32	43	56	71	88	106	126	148	171	197	224	253	283	313	350	386	423	458
15	23	34	46	60	76	94	113	135	158	184	211	240	271	303	336	375	413	458	498
16	25	36	49	64	81	100	121	144	169	196	225	256	289	324	359	400	441	484	528
17	27	38	52	68	86	106	128	153	180	208	239	272	307	344	383	425	469	514	560
18	28	41	55	72	91	112	136	162	190	220	253	288	325	364	406	450	496	544	592
19	30	43	58	76	96	119	143	171	201	233	267	304	343	384	429	475	524	575	628
20	31	46	61	80	101	125	151	180	211	245	280	320	361	404	452	500	551	605	660
21	33	48	64	84	106	131	158	189	222	257	295	336	379	425	473	525	579	635	692
22	34	50	67	88	111	137	166	198	232	269	309	352	397	445	496	550	606	665	725
23	36	52	70	92	116	144	174	207	243	282	323	368	415	465	519	575	634	696	762
24	37	54	74	96	122	150	181	216	253	294	338	384	433	486	541	600	661	726	794
25	39	56	77	100	127	156	189	225	264	306	351	400	451	506	562	625	689	756	826
26	41	59	80	104	132	163	196	234	275	318	366	416	470	526	586	650	717	786	858
27	42	61	83	108	137	169	204	243	285	331	380	432	488	546	606	675	744	817	892
28	44	63	86	112	142	175	212	252	296	343	394	448	506	566	626	700	772	847	924
29	45	65	89	116	147	182	219	261	306	355	408	464	524	586	649	725	799	877	958
30	47	68	92	120	152	188	226	270	317	367	421	480	542	606	672	750	827	907	990
31	48	70	95	124	157	193	234	279	327	380	436	496	560	627	695	775	854	938	1024
32	50	72	98	128	162	200	242	288	338	392	450	512	578	648	718	800	882	968	1058
33	52	74	101	132	167	206	249	297	349	404	464	528	596	668	742	825	910	998	1092
34	53	77	104	136	172	212	256	306	359	416	478	544	614	688	766	850	937	1028	1122
35	55	79	107	140	177	219	265	315	370	429	492	560	632	708	789	875	965	1059	1156
36	56	81	110	144	182	225	272	324	380	441	506	576	650	729	812	900	992	1089	1188
37	58	83	113	148	187	231	280	333	391	453	520	592	668	749	835	925	1020	1119	1220
38	59	85	116	152	192	237	287	342	401	465	534	608	686	769	857	950	1047	1149	1252
39	61	88	119	155	197	243	295	351	412	478	548	624	704	790	880	975	1075	1180	1288
40	62	90	122	160	202	250	302	360	422	490	562	640	722	810	903	1000	1102	1210	1320

DOYLE RULE — continued

Length in Feet		Diameter in Inches														Length in Feet			
		27	28	29	30	31	32	33	34	35	36	37	38	39	40			41	42
8	264	288	312	338	364	392	420	450	480	512	544	578	612	648	684	722	761	800	8
9	297	324	352	380	410	441	473	506	540	576	613	650	689	729	770	812	856	900	9
10	330	360	391	422	456	490	526	562	601	640	681	723	765	810	856	902	951	1000	10
11	363	396	430	465	502	539	578	619	661	704	749	795	842	891	941	993	1046	1100	11
12	397	432	469	507	547	588	631	675	721	768	817	867	910	972	1027	1083	1141	1200	12
13	430	468	508	549	592	637	683	731	781	832	884	939	996	1053	1112	1173	1237	1300	13
14	463	504	547	591	638	686	736	787	841	896	953	1011	1070	1134	1198	1264	1331	1400	14
15	496	540	586	633	683	735	789	844	901	960	1021	1083	1149	1215	1284	1354	1426	1500	15
16	530	576	625	676	729	784	841	900	961	1024	1089	1156	1225	1296	1369	1444	1521	1600	16
17	563	612	664	718	774	833	894	956	1021	1088	1157	1228	1302	1377	1455	1534	1616	1700	17
18	596	648	702	761	820	882	946	1012	1081	1152	1225	1300	1379	1458	1540	1625	1711	1800	18
19	630	684	740	803	865	931	999	1069	1141	1216	1293	1372	1455	1539	1626	1715	1806	1900	19
20	661	720	782	845	912	980	1051	1125	1202	1280	1361	1446	1530	1620	1711	1805	1902	2000	20
21	693	756	820	887	957	1028	1104	1181	1261	1344	1430	1518	1607	1701	1797	1895	1997	2100	21
22	726	792	860	930	1004	1079	1156	1237	1322	1408	1497	1590	1684	1782	1882	1986	2091	2200	22
23	760	828	898	972	1049	1127	1209	1293	1381	1472	1566	1662	1761	1863	1968	2076	2187	2300	23
24	794	864	938	1014	1094	1176	1262	1350	1442	1536	1634	1734	1838	1944	2053	2166	2282	2400	24
25	827	900	977	1056	1139	1225	1314	1406	1501	1600	1702	1806	1915	2025	2139	2256	2376	2500	25
26	860	936	1016	1098	1184	1274	1367	1462	1562	1664	1768	1878	1992	2106	2225	2346	2472	2600	26
27	893	972	1055	1140	1230	1323	1420	1518	1622	1728	1838	1950	2067	2187	2310	2437	2567	2700	27
28	926	1004	1080	1162	1256	1352	1452	1555	1662	1772	1886	2002	2121	2248	2396	2527	2662	2800	28
29	959	1044	1133	1224	1321	1421	1524	1631	1742	1856	1974	2095	2221	2349	2481	2617	2756	2900	29
30	992	1080	1172	1266	1366	1470	1577	1687	1802	1920	2042	2166	2298	2430	2567	2707	2852	3000	30
31	1026	1116	1211	1309	1412	1519	1629	1743	1862	1984	2110	2239	2373	2511	2652	2798	2946	3100	31
32	1060	1152	1250	1352	1458	1568	1682	1800	1922	2048	2178	2312	2450	2592	2738	2888	3042	3200	32
33	1093	1188	1289	1394	1503	1617	1735	1856	1982	2112	2246	2386	2526	2673	2824	2978	3137	3300	33
34	1126	1224	1328	1436	1548	1666	1787	1912	2042	2176	2314	2456	2604	2754	2909	3068	3232	3400	34
35	1159	1260	1367	1479	1594	1715	1840	1968	2102	2240	2383	2529	2681	2835	2995	3159	3327	3500	35
36	1192	1296	1406	1522	1640	1764	1892	2025	2162	2304	2450	2601	2756	2916	3080	3249	3423	3600	36
37	1223	1332	1445	1563	1686	1813	1945	4081	2222	2368	2518	2673	2833	2997	3166	3349	3517	3700	37
38	1256	1368	1484	1606	1731	1862	1998	2138	2282	2432	2586	2745	2909	3078	3251	3429	3612	3800	38
39	1289	1404	1523	1648	1778	1911	2050	2194	2342	2496	2654	2818	2986	3159	3337	3520	3707	3900	39
40	1322	1440	1562	1690	1822	1960	2102	2250	2402	2560	2722	2890	3062	3240	3423	3610	3802	4000	40

## MAINE, HOLLAND, OR BANGOR LOG RULE

Length in Feet	Diameter in Inches																		
	6	7	8	9	10	11	12	13	14	15	16	17	18	19	20	21	22	23	24
10	12	19	27	32	42	51	65	75	89	101	111	128	145	169	189	210	227	250	274
11	14	21	30	36	46	57	70	81	98	111	123	142	160	187	209	232	250	274	298
12	15	23	33	39	51	62	78	90	107	121	134	154	174	203	227	252	272	300	327
13	17	25	36	43	55	67	85	98	115	131	145	167	189	220	246	273	295	326	357
14	18	27	39	46	59	72	92	105	124	141	157	179	203	237	265	294	318	351	384
15	19	29	41	49	64	78	98	113	133	151	168	192	218	254	284	315	340	376	412
16	20	31	44	52	68	83	105	120	142	161	179	205	232	271	302	336	363	401	439
17	22	33	47	56	72	88	111	128	151	171	190	218	247	288	321	357	386	426	466
18	23	35	50	59	76	93	118	135	160	181	201	231	261	305	340	378	408	451	494
19	24	37	52	62	81	98	124	143	169	192	212	243	276	322	359	399	431	476	521
20	25	39	55	65	85	103	131	150	178	202	223	256	290	339	378	420	454	501	549
21	27	41	58	69	89	109	137	158	186	212	235	269	305	356	397	441	476	526	576
22	28	43	61	72	94	114	144	165	195	222	246	282	319	373	415	462	499	551	604
23	29	45	63	75	98	119	150	173	204	232	257	295	334	390	435	483	522	576	631
24	30	47	66	78	102	124	157	180	213	242	268	307	348	407	454	504	547	601	659
25	32	49	69	82	106	129	164	188	222	252	279	320	363	424	473	525	567	626	686
26	33	50	72	85	111	134	170	195	231	262	291	333	378	441	491	545	590	651	713
27	34	52	74	88	115	140	177	203	240	272	302	346	392	458	510	566	613	676	741
28	36	54	76	92	119	145	183	210	249	282	313	359	407	475	529	587	635	701	768
29	37	56	79	95	123	150	190	218	258	292	324	371	421	492	548	608	658	726	796
30	38	58	82	98	128	155	196	225	266	302	335	384	436	509	567	629	681	751	823

MAINE, HOLLAND, OR BANGOR LOG RULE — *continued*

Length in Feet	Diameter in Inches																	
	25	26	27	28	29	30	31	32	33	34	35	36	37	38	39	40	41	42
10	298	317	341	383	410	441	472	495	530	562	593	641	681	709	756	788	834	877
11	328	350	378	424	454	492	519	544	583	618	652	705	749	780	831	867	917	965
12	358	380	410	460	493	530	567	594	636	675	712	770	817	851	907	946	1001	1052
13	388	412	444	499	534	574	614	643	689	731	771	834	885	922	983	1025	1085	1139
14	417	444	478	537	575	618	661	693	742	787	831	898	953	993	1053	1103	1169	1226
15	447	475	512	575	616	662	708	742	795	843	890	962	1021	1064	1134	1182	1252	1314
16	477	507	546	614	657	706	755	792	848	900	949	1026	1089	1135	1209	1261	1336	1401
17	507	539	580	653	698	751	803	841	901	956	1008	1090	1157	1206	1285	1340	1419	1489
18	537	570	615	690	739	795	850	891	954	1012	1068	1155	1225	1277	1360	1419	1503	1576
19	566	602	649	729	780	839	897	940	1007	1069	1127	1219	1293	1348	1436	1498	1586	1664
20	596	634	683	767	821	883	944	990	1060	1125	1187	1283	1362	1419	1512	1576	1670	1752
21	626	665	717	805	862	927	991	1039	1113	1181	1246	1347	1430	1490	1587	1655	1753	1839
22	656	697	751	844	903	971	1039	1089	1166	1237	1305	1411	1498	1561	1663	1734	1837	1927
23	686	729	785	882	944	1015	1086	1138	1219	1293	1365	1475	1566	1632	1738	1813	1920	2014
24	715	761	819	920	985	1060	1133	1188	1272	1350	1424	1539	1634	1703	1814	1892	2004	2102
25	745	792	853	959	1027	1104	1180	1237	1325	1405	1483	1603	1702	1774	1889	1971	2087	2189
26	775	824	888	997	1068	1148	1227	1286	1378	1462	1543	1668	1770	1844	1965	2049	2170	2277
27	805	856	922	1035	1109	1192	1275	1336	1431	1518	1601	1732	1838	1915	2041	2128	2254	2365
28	835	887	956	1074	1150	1236	1322	1385	1484	1574	1661	1796	1906	1986	2116	2207	2337	2452
29	864	919	990	1112	1191	1280	1369	1435	1537	1630	1721	1860	1974	2057	2192	2286	2421	2540
30	894	951	1024	1151	1232	1324	1416	1484	1590	1687	1780	1924	2042	2128	2257	2365	2534	2627

## PROVINCE OF QUEBEC

Table of Contents of Saw Logs, Boom and Dimension Timber in Feet Board Measure

LENGTH	DIAMETER IN INCHES																		
	4	5	6	7	8	9	10	11	12	13	14	15	16	17	18	19	20		
ft.																			
10	6	9	10	15	20	28	37	42	50	62	75	83	100	117	133	154	175		
11	7	10	11	16	22	31	40	46	55	69	82	92	110	128	147	170	192		
12	8	11	12	18	24	34	44	50	60	75	90	100	120	140	160	185	210		
13	9	12	13	19	26	37	48	54	65	81	97	108	130	152	173	200	227		
14	10	13	14	21	28	40	51	58	70	87	105	117	140	163	187	216	245		
15	11	14	15	22	30	42	55	62	75	94	112	125	150	175	200	231	262		
16	12	15	16	24	32	45	59	67	80	100	120	133	160	187	213	247	280		
17	..	..	17	25	34	48	62	71	85	106	127	142	170	198	227	262	297		
18	..	..	18	27	36	51	66	75	90	112	135	150	180	210	240	277	315		
19	..	..	19	28	38	54	70	79	95	119	142	158	190	222	253	293	332		
20	..	..	20	30	40	57	73	83	100	125	150	167	200	233	267	308	350		
21	..	..	21	31	42	59	77	87	105	131	157	175	210	245	280	324	367		
22	..	..	22	33	44	62	81	92	110	137	165	183	220	257	293	339	385		
23	..	..	23	34	46	65	84	96	115	144	172	192	230	268	307	355	402		
24	..	..	24	36	48	68	88	100	120	150	180	200	240	280	320	370	420		
25	..	..	25	37	50	71	92	104	125	156	187	208	250	292	333	385	437		
26	..	..	26	39	52	74	95	108	130	162	195	217	260	303	347	401	455		
27	..	..	27	40	54	76	99	112	135	169	202	225	270	315	360	416	472		
28	..	..	28	42	56	79	103	117	140	175	210	233	280	327	373	432	490		
29	..	..	29	43	58	82	106	121	145	181	217	242	290	338	387	447	507		
30	..	..	30	45	60	85	110	125	150	187	225	250	300	350	400	462	525		
31	..	..	31	46	62	88	114	129	155	194	232	258	310	362	413	478	542		
32	..	..	32	48	64	91	117	133	160	200	240	267	320	373	427	493	560		
33	..	..	33	49	66	93	121	137	165	206	247	275	330	385	440	509	577		
34	..	..	34	51	68	96	125	142	170	212	225	283	340	397	453	524	595		
35	..	..	35	52	70	99	128	146	175	219	262	292	350	408	467	540	612		
36	..	..	36	54	72	102	132	150	180	225	270	300	360	420	480	555	630		
37	..	..	37	55	74	105	136	154	185	231	277	308	370	432	493	570	647		
38	..	..	38	56	76	108	139	158	190	237	285	317	380	443	507	586	665		
39	..	..	39	57	78	111	143	162	195	244	292	325	390	455	520	601	682		
40	..	..	40	60	80	114	147	167	200	250	300	333	400	467	533	617	700		

PROVINCE OF QUEBEC

Table of Contents of Saw Logs, Boom and Dimension Timber in Feet Board Measure

DIAMETER IN INCHES												LENGTH
21	22	23	24	25	26	27	28	29	30	31	32	
192	217	240	262	283	317	333	362	392	421	450	475	ft. 10
211	238	264	289	312	348	367	399	431	463	495	522	11
230	260	288	315	340	380	400	435	470	505	540	570	12
249	282	312	341	368	412	433	471	509	547	585	617	13
268	303	336	367	397	443	467	507	548	589	630	665	14
287	325	360	394	425	475	500	544	587	631	675	712	15
307	347	384	420	453	507	533	580	627	673	720	760	16
326	368	408	446	482	538	567	616	666	715	765	807	17
345	390	432	472	510	570	600	652	705	757	810	855	18
364	412	456	499	538	602	633	689	744	800	855	902	19
383	433	480	525	567	633	667	725	783	842	900	950	20
402	455	504	551	595	665	700	761	822	884	945	997	21
422	477	528	577	623	697	733	797	862	926	990	1045	22
441	498	552	604	652	728	767	834	901	968	1035	1092	23
460	520	576	630	680	760	800	870	940	1010	1080	1140	24
479	542	600	656	708	792	833	906	979	1052	1125	1187	25
498	563	624	682	737	823	867	942	1018	1094	1170	1235	26
517	585	648	709	765	855	900	979	1057	1136	1215	1282	27
537	607	672	735	793	887	933	1015	1097	1178	1260	1330	28
556	628	696	761	822	918	967	1051	1136	1220	1305	1377	29
575	650	720	787	850	950	1000	1087	1175	1262	1350	1425	30
594	672	744	814	878	982	1033	1124	1214	1305	1395	1472	31
613	693	768	840	907	1013	1067	1160	1253	1347	1440	1520	32
632	715	792	866	935	1045	1100	1196	1292	1389	1485	1567	33
652	737	816	892	963	1077	1133	1232	1332	1431	1530	1615	34
671	758	840	919	992	1108	1167	1269	1371	1473	1575	1662	35
690	780	864	945	1020	1140	1200	1305	1410	1515	1620	1710	36
709	802	888	971	1048	1172	1233	1341	1449	1557	1665	1757	37
728	823	912	997	1077	1203	1267	1377	1488	1599	1710	1805	38
747	845	936	1024	1105	1235	1300	1414	1527	1641	1755	1852	39
767	867	960	1050	1133	1267	1333	1450	1567	1683	1800	1900	40

## PROVINCE OF QUEBEC

Table of Contents of Saw Logs, Boom and Dimension Timber in Feet Board Measure

LENGTH	DIAMETER IN INCHES											
	33	34	35	36	37	38	39	40	41	42	43	
ft.												
10	525	542	567	592	617	655	692	733	758	792	833	
11	577	596	623	651	678	715	761	807	834	871	917	
12	630	650	680	710	740	780	830	880	910	950	1000	
13	682	704	737	769	802	845	899	953	986	1029	1083	
14	735	758	793	828	863	910	968	1027	1062	1108	1177	
15	787	812	850	887	925	975	1037	1100	1137	1187	1250	
16	840	867	907	947	987	1040	1107	1173	1213	1267	1333	
17	892	921	963	1006	1048	1105	1176	1247	1289	1346	1417	
18	945	975	1020	1065	1110	1170	1245	1320	1365	1425	1500	
19	997	1029	1077	1124	1172	1235	1314	1393	1441	1504	1583	
20	1050	1083	1133	1183	1233	1300	1383	1467	1517	1583	1667	
21	1102	1137	1190	1242	1295	1365	1452	1540	1592	1662	1750	
22	1155	1192	1247	1302	1357	1430	1522	1613	1668	1742	1833	
23	1207	1246	1303	1361	1418	1495	1591	1687	1744	1821	1917	
24	1260	1300	1360	1420	1480	1550	1660	1760	1820	1900	2000	
25	1312	1354	1417	1479	1542	1625	1728	1833	1896	1979	2083	
26	1365	1408	1473	1538	1603	1690	1796	1907	1972	2058	2167	
27	1417	1462	1530	1597	1665	1755	1867	1980	2047	2137	2250	
28	1470	1517	1587	1657	1727	1820	1937	2053	2123	2217	2333	
29	1522	1571	1643	1716	1788	1885	2006	2127	2199	2296	2417	
30	1575	1625	1700	1775	1850	1950	2075	2200	2275	2375	2500	
31	1627	1679	1757	1834	1912	2015	2144	2273	2351	2454	2583	
32	1680	1733	1813	1893	1973	2080	2213	2347	2427	2533	2667	
33	1732	1787	1870	1952	2035	2145	2282	2420	2502	2612	2750	
34	1785	1842	1927	2012	2097	2210	2352	2493	2578	2692	2833	
35	1837	1896	1983	2071	2158	2275	2421	2567	2654	2771	2917	
36	1890	1950	2040	2130	2220	2340	2490	2640	2730	2850	3000	
37	1942	2004	2097	2189	2282	2405	2559	2713	2806	2929	3083	
38	1995	2058	2153	2248	2343	2470	2628	2787	2882	3008	3167	
39	2047	2112	2210	2307	2405	2535	2697	2860	2957	3087	3250	
40	2100	2167	2267	2367	2467	2600	2767	2933	3033	3167	3333	

NEW BRUNSWICK LOG RULE

Length in Ft.	Diameter at Top in Inches													
	11	12	13	14	15	16	17	18	19	20	21	22	23	24
12	60	72	84	98	112	128	149	172	196	225	247	272	297	324
14	70	84	98	114	131	149	174	200	228	262	288	317	336	380
16	80	96	112	130	150	170	198	229	261	300	327	362	376	432
18	90	108	126	147	168	192	223	258	294	337	370	408	445	486
20	100	120	140	163	187	213	248	286	326	375	411	453	495	540
21	105	126	147	171	196	223	261	301	343	393	432	476	519	569
22	110	132	154	179	205	234	275	315	359	412	453	498	544	594
24	120	144	168	196	224	256	298	344	392	450	494	544	594	648
26	142	168	196	226	259	298	346	396	453	509	560	614	660	730
28	154	182	212	245	280	323	374	428	490	550	605	653	716	788
30	164	194	226	261	299	344	398	457	523	588	644	698	756	840
32	176	208	242	280	320	368	427	490	561	627	689	738	808	898
34	186	220	256	297	336	390	452	519	594	664	732	784	877	952
36	198	234	273	315	360	415	481	552	631	707	778	853	931	1011
38	208	246	287	331	379	436	506	580	663	745	829	898	981	1065
40	220	260	303	350	400	461	534	612	701	786	864	948	1035	1123
42	231	273	318	367	419	484	562	644	736	825	908	995	1088	1181
44	242	286	333	384	439	509	590	674	771	865	951	1042	1138	1235
46	252	298	347	401	458	531	613	703	804	903	992	1088	1188	1289
48	264	312	364	420	480	554	642	736	842	944	1038	1138	1242	1348
50	286	336	392	450	515	596	690	788	903	1003	1104	1208	1308	1430

UNDERSIZED LOGS

A log measuring 7 inches at the top contains twice as many superficial feet as its own length.

A log measuring 8 inches,  $2\frac{1}{2}$  times its length.

A log measuring 9 inches, 3 times its length.

A log measuring 10 inches, 4 times its length.

CLARK'S INTERNATIONAL LOG RULE

Diameter	Length — Feet												
	8	9	10	11	12	13	14	15	16	17	18	19	20
Ins.	Volume — Board Feet												
6	10	10	10	15	15	15	20	20	20	25	25	30	30
7	15	15	15	20	20	25	25	30	30	35	35	40	45
8	20	20	25	25	30	35	35	40	45	45	50	55	60
9	25	30	30	35	40	45	50	50	55	60	65	70	75
10	30	35	40	45	50	55	60	65	70	75	85	90	95
11	40	45	50	55	65	70	75	80	90	95	105	110	115
12	50	55	65	70	75	85	90	100	105	115	125	130	140
13	60	65	75	85	90	100	110	120	130	140	145	155	165
14	70	80	90	100	110	120	130	140	150	160	175	185	195
15	80	90	105	115	125	140	150	160	175	185	200	215	225
16	95	105	120	130	145	160	170	185	200	215	230	245	260
17	105	120	135	150	165	180	195	210	225	245	260	275	295
18	120	135	155	170	185	205	220	240	255	275	295	310	330
19	135	155	175	190	210	230	250	270	290	310	330	350	370
20	150	170	195	215	235	255	275	300	320	345	365	390	410
21	170	190	215	235	260	285	305	330	355	380	405	430	455
22	185	210	235	260	285	315	340	365	390	420	445	475	500
23	205	230	260	285	315	345	370	400	430	460	490	520	550
24	225	255	285	315	345	375	405	440	470	500	535	565	600
25	245	275	310	345	375	410	445	475	510	545	580	615	650
26	265	300	335	370	405	445	480	520	555	595	630	670	705
27	290	325	365	405	440	480	520	560	600	640	680	725	765
28	310	350	395	435	475	520	560	605	645	690	735	780	825
29	335	380	425	470	510	560	605	650	695	740	790	835	885
30	360	405	455	500	550	600	645	695	745	795	845	895	950
31	385	435	485	540	590	640	695	745	800	850	905	960	1015
32	410	465	520	575	630	685	740	795	850	910	965	1025	1080
33	440	495	555	610	670	730	790	850	905	970	1030	1090	1150
34	470	530	590	650	715	775	840	900	965	1030	1095	1160	1225
35	495	560	625	690	755	825	890	955	1025	1095	1160	1230	1300
36	525	595	665	735	800	875	945	1015	1085	1160	1230	1305	1375
37	560	630	705	775	850	925	1000	1075	1150	1225	1300	1380	1455
38	590	665	745	820	895	975	1055	1135	1210	1295	1375	1455	1535
39	620	705	785	865	945	1030	1110	1195	1280	1365	1450	1535	1620
40	655	740	825	910	995	1085	1170	1260	1345	1435	1525	1615	1705
41	690	780	870	960	1050	1140	1230	1325	1415	1510	1605	1700	1795
42	725	820	915	1010	1100	1200	1295	1390	1490	1585	1685	1785	1885
43	760	860	960	1060	1155	1260	1360	1460	1560	1665	1770	1870	1975
44	800	900	1005	1110	1215	1320	1425	1530	1635	1745	1855	1960	2070
45	835	945	1055	1160	1270	1380	1490	1600	1715	1825	1940	2050	2165
46	875	990	1100	1215	1330	1445	1560	1675	1790	1910	2030	2145	2265
47	915	1035	1150	1270	1390	1510	1630	1750	1870	1995	2120	2240	2365
48	955	1080	1205	1325	1450	1575	1700	1830	1955	2085	2210	2340	2470

SPAULDING LOG RULE OF COLUMBIA RIVER

LENGTH	DIAMETER IN INCHES												
	10	11	12	13	14	15	16	17	18	19	20	21	22
ft.													
12	38	47	58	71	86	103	121	141	162	184	207	231	256
14	44	55	67	82	100	120	141	164	189	214	241	269	298
16	50	63	77	94	114	137	161	188	216	245	276	308	341
18	57	70	87	106	129	154	181	211	243	276	310	346	384
20	63	78	96	118	143	171	201	235	270	306	345	385	426
22	69	86	106	130	157	188	221	258	297	337	379	423	469
24	76	94	116	142	172	206	242	282	324	368	414	462	512
26	82	101	125	153	186	223	262	305	351	398	448	500	554
28	88	109	134	164	200	240	282	328	378	428	482	538	596
30	94	117	144	176	214	257	302	352	405	459	517	577	639
32	101	125	154	188	228	274	322	376	432	490	552	616	682
34	107	132	164	200	243	291	342	399	459	521	586	654	725
36	113	140	174	212	258	308	362	422	486	552	620	692	768
38	120	148	183	224	272	325	382	446	513	582	655	731	810
40	126	156	192	236	286	342	402	470	540	612	690	770	852
42	132	164	202	248	300	359	422	493	567	643	724	808	895
44	138	172	212	260	314	376	442	516	594	674	758	846	938
46	145	179	222	272	329	394	463	540	621	705	793	885	981
48	151	187	232	284	344	412	484	564	648	736	828	924	1024
50	157	195	241	295	358	429	504	587	675	766	862	962	1066
	23	24	25	26	27	28	29	30	31	32	33	34	
ft.													
12	282	309	337	366	396	427	459	492	526	561	597	634	
14	329	360	393	427	462	498	535	574	613	654	696	739	
16	376	412	449	488	528	569	612	656	701	748	796	845	
18	423	463	505	549	594	640	688	738	789	841	895	951	
20	470	515	561	610	660	711	765	820	876	935	995	1056	
22	517	566	617	671	726	782	841	902	964	1028	1094	1162	
24	564	618	674	732	792	854	918	984	1052	1122	1194	1268	
26	611	669	730	793	858	925	994	1066	1139	1215	1293	1373	
28	658	720	786	854	924	996	1070	1148	1226	1308	1392	1478	
30	705	772	842	915	990	1067	1147	1230	1314	1402	1492	1584	
32	752	824	898	976	1056	1138	1224	1312	1402	1496	1592	1690	
34	799	875	954	1037	1122	1209	1300	1394	1490	1589	1691	1796	
36	846	926	1010	1098	1188	1280	1376	1476	1578	1682	1790	1902	
38	893	978	1066	1159	1254	1351	1453	1558	1665	1776	1890	2007	
40	940	1030	1122	1220	1320	1422	1530	1640	1752	1870	1990	2112	
42	987	1081	1178	1281	1386	1493	1606	1722	1840	1963	2089	2218	
44	1034	1132	1234	1342	1452	1564	1682	1804	1928	2056	2188	2324	
46	1081	1184	1291	1403	1518	1636	1759	1886	2016	2150	2288	2430	
48	1128	1236	1348	1464	1584	1708	1836	1968	2104	2244	2388	2536	
50	1175	1287	1404	1525	1650	1779	1912	2050	2191	2337	2487	2641	

SPAULDING LOG RULE—*continued*

LENGTH	DIAMETER IN INCHES												
	35	36	37	38	39	40	41	42	43	44	45	46	
ft.													
12	673	713	755	798	843	889	936	984	1033	1086	1134	1186	
14	785	831	880	931	983	1037	1092	1148	1205	1267	1323	1383	
16	897	950	1006	1064	1124	1185	1248	1312	1377	1448	1512	1581	
18	1009	1069	1132	1197	1264	1333	1404	1476	1549	1629	1701	1779	
20	1121	1188	1258	1330	1405	1481	1560	1640	1721	1810	1890	1976	
22	1233	1307	1384	1463	1545	1629	1716	1804	1893	1991	2079	2174	
24	1346	1426	1510	1596	1686	1778	1872	1968	2066	2172	2268	2372	
26	1458	1544	1635	1729	1826	1926	2028	2132	2238	2353	2457	2569	
28	1570	1662	1760	1862	1966	2074	2184	2296	2410	2534	2646	2766	
30	1682	1781	1886	1995	2107	2222	2340	2460	2582	2715	2835	2964	
32	1794	1900	2012	2128	2248	2370	2496	2624	2754	2896	3024	3162	
34	1906	2019	2138	2261	2388	2518	2652	2788	2926	3077	3213	3360	
36	2018	2138	2264	2394	2528	2666	2808	2952	3098	3258	3402	3558	
38	2130	2257	2390	2527	2669	2814	2964	3116	3270	3439	3591	3755	
40	2242	2376	2516	2660	2810	2962	3120	3280	3442	3620	3780	3952	
42	2354	2495	2642	2793	2950	3110	3276	3444	3614	3801	3969	4150	
44	2466	2614	2768	2926	3090	3258	3432	3608	3786	3982	4158	4348	
46	2579	2733	2894	3059	3231	3407	3588	3772	3959	4163	4347	4546	
48	2692	2852	3020	3192	3372	3556	3744	3936	4132	4344	4536	4744	
50	2804	2970	3145	3325	3512	3704	3900	4100	4304	4525	4725	4941	
	47	48	49	50	51	52	53	54	55	56	57	58	
ft.													
12	1239	1293	1348	1404	1461	1519	1578	1638	1700	1763	1827	1893	
14	1445	1508	1572	1638	1704	1772	1841	1911	1983	2056	2131	2208	
16	1652	1724	1797	1872	1948	2025	2104	2184	2266	2350	2436	2524	
18	1858	1939	2022	2106	2191	2278	2367	2457	2550	2644	2740	2839	
20	2065	2155	2246	2340	2435	2531	2630	2730	2833	2938	3045	3155	
22	2271	2370	2470	2574	2678	2784	2893	3003	3116	3232	3349	3470	
24	2478	2586	2696	2808	2922	3038	3156	3276	3400	3526	3654	3786	
26	2684	2801	2920	3042	3165	3291	3419	3549	3683	3819	3958	4101	
28	2890	3016	3144	3276	3408	3544	3682	3822	3966	4112	4262	4416	
30	3097	3232	3369	3510	3652	3797	3945	4095	4249	4406	4567	4732	
32	3304	3448	3594	3744	3896	4050	4208	4368	4532	4700	4872	5048	
34	3510	3663	3819	3978	4139	4303	4471	4641	4816	4994	5176	5363	
36	3716	3878	4044	4212	4382	4556	4734	4914	5100	5288	5480	5678	
38	3923	4094	4268	4446	4626	4809	4997	5187	5383	5582	5785	5994	
40	4130	4310	4492	4680	4870	5062	5260	5460	5666	5876	6090	6310	
42	4336	4525	4716	4914	5113	5315	5523	5733	5949	6170	6394	6625	
44	4542	4740	4940	5148	5356	5568	5786	6006	6232	6464	6698	6940	
46	4749	4956	5166	5382	5600	5822	6049	6279	6516	6758	7003	7256	
48	4956	5172	5392	5616	5844	6076	6312	6552	6800	7052	7304	7572	
50	5162	5387	5616	5850	6087	6329	6575	6825	7083	7345	7612	7887	

SPAULDING LOG RULE—*continued*

LENGTH	DIAMETER IN INCHES											
	59	60	61	62	63	64	65	66	67	68	69	70
ft.												
12	1960	2028	2098	2169	2241	2315	2390	2467	2545	2625	2706	2789
14	2286	2366	2447	2530	2614	2700	2789	2878	2969	3062	3157	3253
16	2613	2704	2797	2892	2988	3086	3186	3289	3393	3500	3608	3718
18	2940	3042	3147	3253	3361	3472	3585	3700	3817	3937	4059	4183
20	3266	3380	3496	3615	3735	3858	3983	4111	4241	4375	4510	4648
22	3592	3718	3846	3976	4108	4244	4381	4522	4665	4812	4961	5113
24	3920	4056	4196	4338	4482	4630	4780	4934	5090	5250	5412	5578
26	4246	4394	4545	4699	4855	5015	5179	5345	5514	5687	5863	6042
28	4572	4732	4894	5060	5228	5400	5578	5756	5938	6124	6314	6506
30	4899	5070	5244	5422	5602	5786	5975	6167	6362	6562	6765	6971
32	5226	5408	5594	5784	5976	6172	6372	6578	6786	7000	7216	7436
34	5553	5746	5944	6145	6349	6558	6771	6989	7210	7437	7667	7901
36	5880	6084	6294	6506	6722	6944	7170	7400	7634	7874	8118	8366
38	6206	6422	6643	6868	7096	7330	7568	7811	8058	8312	8569	8831
40	6532	6760	6992	7230	7470	7716	7966	8222	8482	8750	9020	9296
42	6858	7098	7342	7591	7843	8102	8364	8633	8906	9187	9471	9761
44	7184	7436	7692	7952	8216	8488	8762	9044	9330	9624	9922	
46	7512	7774	8042	8314	8590	8874	9161	9456	9755			
48	7840	8112	8392	8676	8964	9260	9560					
50	8166	8450	8741	9037	9337	9645	9959					

## BRITISH COLUMBIA LOG SCALE

Established by the government, and derived from the following rule:— Deduct  $1\frac{1}{2}$  inches from the mean diameter of the log at the small end; square the result and multiply by .7854; deduct  $\frac{3}{4}$ ; divide by 12; multiply by the length of the log in feet.

Logs more than 40 and not over 50 feet long to be scaled as two logs of equal length, the butt log taken as 1 inch larger than the top. Logs over 50 and not over 60 feet long to be treated similarly, but with 2 inches rise allowed to the butt log; and so on, 1 inch of rise being added for each 10 feet or part thereof over 40 feet.

LENGTH	DIAMETER IN INCHES															
	10	11	12	13	14	15	16	17	18	19	20	21	22	23	24	25
ft.																
1	3	4	5	6	7	9	10	11	13	15	16	18	20	22	24	26
10	34	43	53	63	74	87	100	114	130	146	163	181	200	220	241	263
12	41	52	63	76	89	104	120	137	155	175	195	217	240	264	289	315
14	48	60	73	88	104	121	140	160	181	204	228	253	280	308	337	368
16	55	69	84	101	119	139	160	183	207	233	261	290	320	352	386	421
18	62	77	94	113	134	156	180	206	233	262	293	326	360	396	434	473
20	69	86	105	126	149	173	200	229	259	292	326	362	400	440	482	526
22	76	94	115	138	164	191	220	252	285	321	358	398	440	484	530	578
24	83	103	126	151	178	208	240	274	311	350	391	434	480	528	578	631
26	89	112	136	164	193	226	260	297	337	379	424	471	520	572	626	683
28	96	120	147	176	208	243	280	320	363	408	456	507	560	616	675	736
30	103	129	157	189	223	260	300	343	389	437	489	543	600	660	723	789
32	110	137	168	201	238	278	320	366	415	466	521	579	640	704	771	841
34	117	146	178	214	253	295	340	389	441	496	554	615	680	748	819	894
36	124	155	189	227	268	312	360	412	466	525	586	652	720	792	867	946
38	131	163	199	239	283	330	380	435	492	554	619	688	760	836	916	999
40	138	172	210	252	297	347	400	457	518	583	652	724	800	880	964	1051

BRITISH COLUMBIA LOG SCALE—*continued*

LENGTH	DIAMETER IN INCHES											
	26	27	28	29	30	31	32	33	34	35	36	37
ft.												
1	29	31	33	36	39	41	44	47	50	53	57	60
10	286	309	334	360	387	414	443	472	503	534	567	600
12	343	371	401	432	464	497	531	567	603	641	680	720
14	400	433	468	504	541	580	620	661	704	748	793	840
16	457	495	535	576	619	663	708	756	804	855	906	960
18	514	557	602	648	696	746	797	850	905	961	1020	1080
20	571	619	668	720	773	828	886	945	1005	1068	1133	1200
22	629	681	735	791	850	911	974	1039	1106	1175	1246	1320
24	686	743	802	864	928	994	1063	1133	1207	1282	1360	1440
26	743	805	869	936	1005	1077	1151	1228	1307	1389	1473	1560
28	800	867	936	1008	1082	1160	1240	1322	1408	1496	1586	1679
30	857	928	1003	1080	1160	1243	1328	1417	1508	1602	1700	1799
32	914	990	1070	1152	1237	1325	1417	1511	1609	1709	1813	1919
34	971	1052	1136	1224	1314	1408	1505	1606	1709	1816	1926	2039
36	1028	1114	1203	1296	1392	1491	1594	1700	1810	1923	2039	2159
38	1086	1176	1270	1368	1469	1574	1682	1795	1910	2030	2153	2279
40	1143	1238	1337	1440	1546	1657	1771	1889	2011	2137	2266	2399
	38	39	40	41	42	43	44	45	46	47	48	49
ft.												
1	63	67	71	74	78	82	86	90	94	99	103	107
10	634	669	705	743	781	820	860	901	943	985	1029	1074
12	761	803	847	891	937	984	1032	1081	1131	1182	1235	1289
14	888	937	988	1040	1093	1148	1204	1261	1320	1379	1441	1503
16	1015	1071	1129	1188	1249	1312	1376	1441	1508	1577	1647	1718
18	1141	1205	1270	1337	1405	1475	1547	1621	1697	1774	1852	1933
20	1268	1339	1411	1485	1561	1639	1719	1801	1885	1971	2058	2148
22	1395	1472	1552	1634	1717	1803	1891	1981	2074	2168	2264	2362
24	1522	1606	1693	1782	1874	1967	2063	2161	2262	2365	2470	2577
26	1649	1740	1834	1931	2030	2131	2235	2342	2451	2562	2676	2792
28	1775	1874	1975	2079	2186	2295	2407	2522	2639	2759	2882	3007
30	1902	2008	2116	2228	2342	2459	2579	2702	2828	2956	3087	3222
32	2029	2142	2258	2376	2498	2623	2751	2882	3016	3153	3293	3436
34	2156	2276	2399	2525	2654	2787	2923	3062	3205	3350	3499	3651
36	2283	2410	2540	2673	2810	2951	3095	3242	3393	3547	3705	3866
38	2410	2543	2681	2822	2967	3115	3267	3422	3582	3744	3911	4081
40	2536	2677	2822	2970	3123	3279	3439	3602	3770	3941	4117	4295

BRITISH COLUMBIA LOG SCALE—*continued*

LENGTH	DIAMETER IN INCHES											
	50	51	52	53	54	55	56	57	58	59	60	61
ft.												
1	112	117	121	126	131	136	141	147	152	157	163	168
10	1120	1166	1214	1262	1312	1362	1414	1466	1519	1574	1629	1685
12	1343	1399	1457	1515	1574	1635	1696	1759	1823	1888	1955	2022
14	1567	1633	1699	1767	1837	1907	1979	2052	2127	2203	2280	2359
16	1791	1866	1942	2020	2099	2180	2262	2346	2431	2518	2606	2696
18	2015	2099	2185	2272	2361	2452	2545	2639	2735	2832	2932	3033
20	2239	2332	2428	2525	2624	2725	2827	2932	3039	3147	3258	3370
22	2463	2566	2670	2777	2886	2997	3110	3225	3343	3462	3583	3707
24	2687	2799	2913	3030	3148	3269	3393	3519	3646	3777	3909	4044
26	2911	3032	3156	3282	3411	3542	3676	3812	3950	4091	4235	4381
28	3135	3265	3399	3535	3673	3814	3958	4105	4254	4406	4561	4718
30	3359	3499	3641	3787	3936	4087	4241	4398	4558	4721	4886	5055
32	3583	3732	3884	4039	4198	4359	4524	4691	4862	5036	5212	5392
34	3807	3965	4127	4292	4460	4632	4807	4985	5166	5350	5538	5729
36	4030	4198	4370	4544	4723	4904	5089	5278	5470	5665	5864	6066
38	4254	4432	4612	4797	4985	5177	5372	5571	5774	5980	6190	6403
40	4478	4665	4855	5049	5247	5449	5655	5864	6077	6294	6515	6740
	62	63	64	65	66	67	68	69	70	71	72	73
ft.												
1	174	180	186	192	198	204	210	217	223	230	237	243
10	1742	1800	1859	1919	1980	2042	2105	2169	2233	2299	2366	2433
12	2091	2160	2231	2303	2376	2450	2526	2602	2689	2759	2839	2920
14	2439	2520	2603	2687	2772	2859	2947	3036	3127	3219	3312	3407
16	2787	2880	2975	3071	3168	3267	3368	3470	3573	3678	3785	3893
18	3136	3240	3347	3454	3564	3676	3789	3903	4020	4138	4258	4380
20	3484	3600	3718	3838	3960	4084	4210	4337	4467	4598	4731	4867
22	3833	3960	4090	4222	4356	4492	4631	4771	4913	5058	5204	5353
24	4181	4320	4462	4606	4752	4901	5051	5205	5360	5518	5677	5840
26	4529	4680	4834	4990	5148	5309	5472	5638	5807	5977	6151	6327
28	4878	5040	5206	5374	5544	5717	5893	6072	6253	6437	6624	6813
30	5226	5401	5578	5757	5950	6126	6314	6506	6700	6897	7097	7300
32	5575	5761	5949	6141	6336	6534	6735	6939	7146	7357	7570	7787
34	5923	6121	6321	6525	6732	6943	7156	7373	7593	7816	8043	8273
36	6272	6481	6693	6909	7128	7351	7577	7807	8040	8276	8516	8760
38	6620	6841	7065	7293	7524	7759	7998	8240	8486	8736	8989	9247
40	6968	7201	7437	7677	7920	8168	8419	8674	8933	9196	9462	9734

VOLUME TABLE No. 1. WHITE PINE BY THE SCRIBNER RULE

Breast Diam. Inches	Total Height of Tree — Feet									
	60	70	80	90	100	110	120	130	140	150
10	60	70	80	95	...	....	....	....	....	....
11	75	85	100	115	...	....	....	....	....	....
12	90	100	115	135	...	....	....	....	....	....
13	100	115	135	155	180	....	....	....	....	....
14	120	135	155	180	210	....	....	....	....	....
15	140	160	180	200	230	270	....	....	....	....
16	160	185	210	240	270	310	....	....	....	....
17	...	210	240	270	310	350	....	....	....	....
18	...	240	270	310	350	390	440	....	....	....
19	...	270	310	350	390	440	490	....	....	....
20	...	...	350	390	440	490	550	....	....	....
21	...	...	390	430	480	540	600	680	....	....
22	...	...	440	480	540	600	670	750	....	....
23	...	...	490	540	600	660	740	830	940	....
24	...	...	540	600	660	730	810	910	1020	....
25	...	...	...	660	720	800	890	990	1100	....
26	...	...	...	720	790	870	970	1070	1190	1320
27	...	...	...	...	850	940	1040	1150	1280	1420
28	...	...	...	...	920	1020	1130	1240	1370	1530
29	...	...	...	...	990	1100	1210	1330	1470	1640
30	...	...	...	...	...	1180	1300	1420	1580	1750
31	...	...	...	...	...	1270	1400	1520	1690	1860
32	...	...	...	...	...	1360	1500	1630	1800	1980
33	...	...	...	...	...	1450	1600	1750	1920	2100
34	...	...	...	...	...	1550	1700	1870	2040	2220
35	...	...	...	...	...	1650	1800	1980	2170	2360
36	...	...	...	...	...	1750	1900	2100	2300	2500

Based on 3000 trees cut in New York, the Lake States, and Canada, cut as a rule into 16-foot logs. These scaled with due allowance for crook and breakage, but not for decay. Original.

VOLUME TABLE No. 2. RED PINE, IN BOARD FEET, BY THE  
MINNESOTA SCRIBNER RULE

(Trees under 130 Years Old)

Diameter Breast High	Total Height in Feet				
	Inches	60	70	80	90
7	17	24	...	...	...
8	29	38	50	...	...
9	44	53	68	81	94
10	61	72	88	104	119
11	80	92	110	130	148
12	100	114	136	159	180
13	120	138	160	189	214
14	140	164	189	222	250
15	...	190	220	257	292
16	...	...	252	296	340
17	...	...	...	334	394
18	...	...	...	372	450

VOLUME TABLE No. 3. RED PINE, IN BOARD FEET, BY THE  
MINNESOTA SCRIBNER RULE

(Trees over 200 Years Old)

Diameter Breast High	Total Height in Feet			
	Inches	70	80	90
10	85	105	...	...
11	102	126	147	...
12	122	150	177	...
13	144	176	210	...
14	168	208	246	...
15	193	240	284	...
16	220	275	323	383
17	250	311	370	435
18	282	349	417	490
19	317	390	468	551
20	355	433	523	616
21	396	480	582	685
22	...	530	646	755
23	...	584	715	830
24	...	...	790	905
25	...	...	867	986
26	...	...	951	1075
27	...	...	1041	1166

The preceding tables from Minnesota timber cut into 16-foot logs and scaled straight and sound. By H. H. Chapman.

VOLUME TABLE No 4. WHITE PINE IN FEET—BOARD MEASURE

(From State Forester of Massachusetts)

Diameter Breast High	Total Height of Tree — Feet							
	30	40	50	60	70	80	90	100
5	10	..	..	..	..	...	...	...
6	15	20	30	..	..	...	...	...
7	20	30	40	50	65	...	...	...
8	25	35	50	65	85	...	...	...
9	30	45	60	80	105	115	...	...
10	40	55	75	95	125	145	...	...
11	..	65	90	115	145	170	200	230
12	..	75	105	135	165	200	230	260
13	..	85	120	155	190	235	260	295
14	..	100	140	175	215	265	300	335
15	..	115	160	200	245	300	340	375
16	..	...	180	230	275	335	380	420
17	..	...	...	260	310	370	425	470
18	..	...	...	295	350	410	475	530
19	..	...	...	335	390	455	530	600
20	..	...	...	380	435	505	580	660
21	..	...	...	...	480	550	635	720
22	..	...	...	...	520	595	680	780
23	..	...	...	...	565	640	730	835
24	..	...	...	...	600	690	780	890
25	..	...	...	...	645	740	830	940
26	..	...	...	...	...	...	885	995

Gives yield of trees from  $\frac{1}{2}$  foot stump to 4 inches in the top as sawed into round or waney-edged, or both round and square-edged, lumber. In the smallest sizes of trees appreciably more may be obtained by cutting to a smaller size in the top.

## VOLUME TABLE No. 5. WHITE PINE IN CORDS

(From State Forester of Massachusetts)

Diameter Breast High	Total Height of Tree — Feet							
	Inches	30	40	50	60	70	80	90
5		.03	..	..	..	..	..	..
6		.03	.04	.05	..	..	..	..
7		.04	.05	.07	.09	..	..	..
8		.05	.07	.09	.11	.13	..	..
9		.07	.09	.11	.13	.16	..	..
10		..	.11	.13	.16	.19	.22	..
11		..	.13	.16	.19	.23	.26	.30
12		..	.15	.19	.22	.27	.31	.35
13		..	.17	.22	.26	.31	.36	.40
14		..	..	.25	.30	.34	.41	.45
15		..	..	.28	.34	.40	.46	.51

Includes volume of tree above  $\frac{1}{2}$  foot from ground and up to 4 inches diameter in the top.

## VOLUME TABLE No. 6. SPRUCE IN CUBIC FEET

Breast Diam- eter	Total Height of Tree — Feet										
	Inches	40	45	50	55	60	65	70	75	80	90
6		4.9	5.3	5.8	6.5	...	...	...	...	...	...
7		6.3	6.9	7.6	8.5	9.6	...	...	...	...	...
8		7.8	8.6	9.5	10.6	12.0	14	...	...	...	...
9		9.8	10.8	12.0	13.4	15.0	17	...	...	...	...
10		12.0	13.5	15.0	16.5	18.2	20	21	...	...	...
11		...	16.0	18.0	19.7	22.	23	25	27	...	...
12		...	18.5	21.	23.	25.	27	29	32	34	...
13		...	22.	24.	27.	29.	31	34	36	39	...
14		...	...	28.	30.	33.	36	38	41	44	...
15		...	...	31.	34.	37.	40	43	46	49	...
16		...	...	...	38.	41.	44	47	51	55	63
17		...	...	...	43.	46.	49	52	56	61	70
18		...	...	...	47.	50.	54	58	62	67	77
19		...	...	...	52.	55.	59	64	69	74	85
20		...	...	...	56.	60.	65	70	76	81	93
21		...	...	...	...	...	72	77	82	87	98
22		...	...	...	...	...	79	84	88	93	105
23		...	...	...	...	...	87	92	95	100	114
24		...	...	...	...	...	96	100	104	108	123

Table No. 6 gives volume of tree from ground to tip exclusive of branches. Includes bark, which is about 12½ per cent of the total volume. Based on 2500 trees cut in Maine, New Hampshire, and New York, calipered each 4 feet, computed separately, and averaged. Original.

This table may without great modification be applied to other soft wood species, regard being had to the remarks on tree form on pages 159-165 of this volume. Balsam fir, however, is believed to be pretty uniformly somewhat slimmer than spruce, having, as would appear from the results of a study on fir made by Mr. Zon of the United States Forest Service, 8 per cent less volume for the same breast diameter and height.

VOLUME TABLE No. 7. SPRUCE IN FEET, BOARD MEASURE

Breast Diameter Inches	Total Height of Tree — Feet									
	40	45	50	55	60	65	70	75	80	90
7	20	20	20	25	25	...	...	...	...	...
8	20	25	30	35	40	45	...	...	...	...
9	30	35	40	45	50	55	...	...	...	...
10	40	45	50	60	65	70	80	...	...	...
11	..	55	65	70	80	90	105	115	...	...
12	..	65	75	85	100	110	120	135	150	...
13	..	75	90	100	115	125	140	155	170	...
14	..	..	105	120	135	150	165	180	195	...
15	..	..	120	135	155	170	190	205	220	...
16	..	..	...	155	170	185	205	225	250	315
17	..	..	...	170	190	210	230	250	275	350
18	..	..	...	185	210	235	255	280	310	390
19	..	..	...	205	235	260	290	320	350	430
20	..	..	...	235	265	295	325	355	385	470
21	..	..	...	...	300	330	360	390	425	510
22	..	..	...	...	330	360	395	430	465	550
23	..	..	...	...	360	400	435	470	510	600
24	..	..	...	...	400	440	480	515	555	650

Based on 2500 trees scaled in 16-foot log lengths up to 6 inches in diameter by the Maine rule and discounted from 5 to 10 per cent. Purports to give the yield in edged lumber of average spruce trees in economical woods and mill practice.

VOLUME TABLE No. 8. SPRUCE IN CORDS

Breast Diameter	Total Height of Tree — Feet								
Inches	40	45	50	55	60	65	70	75	80
6	.04	.05	.05	.06	..	..	..	..	..
7	.06	.06	.07	.08	.09	..	..	..	..
8	.07	.08	.09	.10	.12	.13	..	..	..
9	.09	.10	.12	.13	.14	.16	..	..	..
10	.11	.12	.14	.16	.17	.19	.20	.22	..
11	..	.15	.17	.19	.20	.22	.24	.26	.28
12	..	.18	.20	.22	.24	.26	.28	.30	.32
13	..	.21	.23	.25	.27	.30	.32	.34	.37
14	..	..	.26	.29	.31	.34	.36	.39	.42
15	..	..	..	.32	.35	.38	.40	.43	.47
16	..	..	..	.36	.39	.42	.45	.48	.52
17	..	..	..	.40	.43	.46	.50	.54	.59
18	..	..	..	.45	.48	.50	.55	.59	.64
19	..	..	..	.49	.52	.56	.60	.65	.70
20	..	..	..	.52	.57	.62	.66	.72	.77

Table No. 8 derived from Table No. 6 by deducting a fair allowance for waste in stump, also volume of top above 4 inches diameter, and dividing by 96, usual number of cubic feet, solid wood, in a piled cord. The values in this table are very closely confirmed by a table for second growth spruce based on 711 trees that was made up in 1903 by Mr. T. S. Woolsey of the United States Forest Service.

This table may be used for balsam fir, but in general with some deduction. For the amount of this deduction see the preceding page.

YIELD OF HEMLOCK BARK

Where the tanbark industry is large and well organized, 2240 lbs. of dried bark constitute one cord. One thousand feet of hemlock timber, log scale, yields  $\frac{3}{4}$  cord usually, up to a cord in some cases. Small, thrifty hemlock, if closely utilized at the saw, as in parts of New England, yields about  $\frac{1}{2}$  cord per M.

VOLUME TABLE No. 9. HEMLOCK, BY THE SCRIBNER RULE

(From Bulletin No. 152, U. S. Dept. Agriculture, by E. H. Frothingham)

Diameter breast-high	Total Height of Tree — Feet								Diameter inside bark of top
	30	40	50	60	70	80	90	100	
Inches	Feet Board Measure								Inches
8	5	7	13	20	25	..	..	...	6
9	8	14	22	29	35	40	..	...	6
10	12	22	32	40	47	52	..	...	6
11	16	29	42	51	60	67	75	...	6
12	20	37	53	64	76	84	93	...	7
13	..	46	65	78	94	100	110	...	7
14	..	56	77	95	110	130	140	...	7
15	..	65	90	110	130	150	160	...	8
16	..	..	110	130	160	180	190	200	8
17	..	..	120	150	180	210	220	240	8
18	..	..	140	180	210	240	260	280	8
19	..	..	160	200	240	280	300	320	9
20	..	..	180	230	280	310	340	360	9
21	..	..	200	260	310	350	380	410	9
22	..	..	220	290	350	390	430	470	10
23	..	..	...	330	380	440	480	520	10
24	..	..	...	360	420	490	540	580	10
25	..	..	...	390	460	530	600	650	10
26	..	..	...	430	510	580	660	720	11
27	..	..	...	470	550	640	720	790	11
28	..	..	...	500	590	690	780	870	11
29	..	..	...	540	640	750	850	940	11
30	..	..	...	570	680	800	920	1030	12

Based on 534 trees cut in the Lake States and scaled from a 2-foot stump to diameter given in 16.3 foot log lengths. Crook, breakage, and defect not allowed for.

VOLUME TABLE No. 10. HEMLOCK IN BOARD FEET  
(From Report N. H. Forest Commission for 1906-7)

Diameter Breast High	Total Height of Tree — Feet					
	Inches	30	40	50	60	70
6	5	...	...	...	...	...
7	10	20	30	42	...	...
8	17	28	39	50	...	...
9	26	36	49	60	...	...
10	36	46	59	71	86	86
11	47	58	72	86	103	103
12	60	72	86	103	123	123
13	..	88	104	124	148	148
14	..	107	125	147	173	173
15	..	126	148	172	204	204
16	..	148	171	200	240	240
17	..	...	197	233	281	281

Based on 317 second growth trees grown in New Hampshire, cut with good economy ( $4\frac{1}{2}$  to  $6\frac{1}{2}$  inches in the top) and sawed into edged boards and scantling. Figures derived from actual tally of the sawed lumber.

VOLUME TABLE No. 11. PAPER BIRCH IN CORDS  
(Adapted from Report of N. H. Forest Commission for 1906-7)

Diameter Breast High	Used Length of Tree — Feet				
	Inches	10	20	30	40
6	.02	.04	.05	.07	.08
7	.03	.05	.07	.08	.10
8	.04	.07	.09	.11	.13
9	.05	.08	.11	.13	.16
10	.05	.10	.13	.16	.19
11	.07	.12	.16	.19	.22
12	.08	.14	.19	.22	.26
13	..	.17	.22	.26	.30
14	..	.19	.25	.30	.34
15	..	.22	.29	.34	.38

Based on 427 trees cut to be sawed. Volumes given are of used portion of tree only. Original figures by Forest Service men in cubic feet converted into cords at the ratio of 96 cubic feet solid per cord.

VOLUME TABLE No. 12. RED OAK IN BOARD FEET  
(From Report of N. H. Forest Commission for 1906-7)

Diameter Breast High	Used Length of Tree — Feet				
	Inches	10	20	30	40
5	7	...	...	...	...
6	9	15	...	...	...
7	14	22	29	34	...
8	18	30	39	43	...
9	25	40	48	58	...
10	31	50	60	73	99
11	37	63	74	90	118
12	44	78	89	110	143
13	54	93	107	132	174
14	65	109	126	160	208
15	..	124	149	190	243
16	..	143	173	225	288
17	..	163	201	262	330
18	..	181	232	308	...
19	..	202	265	356	...
20	..	223	300	405	...

Based on about 700 trees tallied through saw mills by members of United States Forest Service. Trees from 50 to 80 years of age, cut off at from 5 to 9 inches at the top. Lumber sawed round or waney-edged; 85 per cent of the product  $1\frac{1}{8}$ -inch boards surveyed as 1 inch; balance  $1\frac{1}{2}$ -inch plank.

Table may be used for other second growth hard wood species when similarly cut and manufactured.

VOLUME TABLE No. 13. PEELED POPLAR IN CORDS  
(Adapted from Report of N. H. Forest Commission for 1906-7)

Diameter Breast High	Total Height of Tree — Feet			
	Inches	50	60	70
5	.02	.02	..	..
6	.03	.04	.05	..
7	.05	.06	.07	.08
8	.06	.08	.10	.12
9	.08	.11	.13	.15
10	..	.13	.16	.18
11	..	..	.20	.24
12	..	..	.25	..
13	..	..	.30	..

Based on 289 trees cut for pulp wood. All diameter measures except diameter breast high taken on the wood surface after peeling off the bark. Original figures in cubic feet, converted into cords at the ratio of 90 cubic feet solid wood per cord.

TABLE 14. SECOND GROWTH HARD WOODS IN CORDS

Diam. Breast High Inches	Total Height of Tree — Feet							
	30	35	40	45	50	55	60	65
	Number Trees per Cord							
3-5	61	47	38	33	31	..	..	..
5-7	..	..	24	20	17	15	14	..
7-9	..	..	..	..	12	11	10	9

From study by Harvard Forest School on oak thinnings. Wood used up to 2 inches in diameter. 80 cubic feet solid wood per cord.

The study showed that when the bolts from the trees 3 to 5 inches in breast diameter were piled by themselves, there were 250 bolts and 67 cubic feet in a cord; wood from the 5- to 7-inch trees piled together gave 173 bolts and 79½ cubic feet; from the 7- to 9-inch trees, 133 bolts and 91 cubic feet.

FORM HEIGHT FACTORS FOR SECOND GROWTH  
HARD WOODS IN CORDS

(Utilized to 1 inch in diameter; 80 cubic feet solid wood per cord.) Sectional Area Breast High  $\times$  F. H. F. = Cords of 128 Cubic Feet of Wood

Diameter Breast High	Basal Area	Total Height in Feet		
		40	50	60
Inches	Sq. Ft.	Form Height Factors		
6	.196	.26	.31	.36
7	.267	.26	.31	.37
8	.349	.27	.32	.38
9	.442	..	.33	.38
10	.545	..	.35	.40
11	.660	..	.37	.43
12	.785	..	.39	.45

SAME FOR CHESTNUT EXTRACT WOOD

(Smaller trees used to 5 inches; 90 cubic feet solid wood per cord.) Sectional Area Breast High  $\times$  F. H. F. = Cords of 128 Cubic Feet of Wood

Diameter Breast High	Total Height of Tree in Feet							
	40	50	60	70	80	90	100	110
Inches	Form Height Factors							
6	.20	.23	.28	..	..	..	..	..
9	.18	.21	.25	.30	..	..	..	..
12	.18	.21	.23	.27	.31	..	..	..
15	.17	.20	.22	.26	.29	.34	.38	..
18	..	.19	.22	.25	.28	.32	.36	..
21	..	.19	.21	.24	.27	.31	.34	..
24	..	.18	.21	.24	.27	.30	.33	..
27	..	.18	.21	.24	.27	.30	.32	.34
30	..	..	.20	.23	.26	.29	.31	.33
36	..	..	..	.22	.25	.28	.31	.33
45	..	..	..	..	.26	.28	.30	.32

If the cord is 4'  $\times$  5'  $\times$  8', deduct  $\frac{1}{8}$  from above figures.

Above tables from "Biltmore Timber Tables," by Howard Krinbill, copyrighted.

To use, caliper or estimate the breast diameter of the tree or stand and get the total height. Then multiply the basal area in square feet (see table on page 238) by the proper factor in the table above. The product gives the result in cords. Considerable stands of timber should be divided into diameter groups.

Example 1. A 10-inch tree is 50 feet high. How much cordwood is in it?  $.545$  (basal area)  $\times$   $.35$  (form height factor) =  $.19$  cord; or  $1 \div .19 = 5\frac{1}{4}$ , number of such trees required for a cord if closely utilized.

Example 2. A bunch of chestnut averaging 80 feet tall and running 13 to 17 inches in diameter, to be cut into extract wood, proves after calipering to have a total basal area of 95 square feet.  $95 \times .29$  (form height factor in second table above) =  $27.55$ , number of cords in the stand.

VOLUME TABLE No. 16. HARD WOODS, IN BOARD FEET, BY THE SCRIBNER RULE

(From R. A. Brotherton, Negaunee, Mich.)

Stump Diameter Inches	Number of Sixteen-Foot Logs			
	1	2	3	4
10	30	50	90	...
12	55	95	130	...
14	80	140	180	...
16	110	180	250	...
18	140	250	340	390
20	190	320	440	540
22	240	400	550	650
24	300	470	640	750
26	360	560	740	900
28	420	680	900	1100
30	500	820	1100	1350

Stumps average about 3 feet high. One and two log trees may either be short trees, or those that above a certain height are faulty or defective.

Elm in the sizes above 18 inches yields about 10 per cent more than the above figures.

VOLUME TABLE No. 17. NORTHERN HARD WOODS (BIRCH, BEECH AND MAPLE) BY THE SCRIBNER RULE

(Adapted from Bulletin No. 285, U. S. Forest Service, by E. H. Frothingham)

Diameter breast-high	Number of 16-foot Logs							Diameter inside bark of top
	1	1½	2	2½	3	3½	4	
Inches	Volume — Board Feet							Inches
9	20	30	45	..	...	...	...	6
10	20	35	50	70	...	...	...	6
11	25	40	60	80	100	...	...	6
12	25	50	70	95	120	140	...	7
13	30	55	80	110	140	170	...	7
14	30	65	95	130	160	190	230	7
15	..	70	110	140	180	220	260	8
16	..	80	120	160	210	250	290	8
17	..	..	140	190	240	280	320	9
18	..	..	160	210	270	320	380	9
19	..	..	...	240	300	360	430	10
20	..	..	...	270	340	410	490	10
21	..	..	...	300	380	460	550	11
22	..	..	...	340	430	520	620	12
23	..	..	...	380	480	580	690	12
24	..	..	...	420	530	640	770	13

Based on 800 trees cut in the Lake States scaled from taper measures in logs 16.3 feet long from a stump 1 foot high to top diameters found in actual logging: figures evened by curves. As no allowance was made for crook and defect, considerable discount is necessary in most timber.

NOTE. Comparison between the values in this table and the preceding shows striking differences, and the text indicates how these arose, from differences in tree form and soundness, lumbering practice, and methods of recording and computing. The cruiser is under obligation before he applies either in practice to understand these points, and he will do well to check the table he uses with local practice and on local timber. That done, however, the tables will apply throughout the distribution of the species.

VOLUME TABLE No. 18. LONGLEAF PINE, IN BOARD FEET,  
BY THE SCRIBNER RULE

Diam- eter breast- high	Total Height of Trees — Feet									Diam- eter inside bark of top
	40	50	60	70	80	90	100	110	120	
Inches	Volume									Inches
7	5	10	15	..	...	...	...	...	...	6
8	10	20	25	..	...	...	...	...	...	6
9	20	30	40	50	...	...	...	...	...	6
10	25	40	55	70	...	...	...	...	...	6
11	35	50	70	90	110	...	...	...	...	6
12	..	65	90	115	135	...	...	...	...	6
13	..	80	110	135	165	195	...	...	...	6
14	..	95	130	160	200	230	...	...	...	7
15	..	115	150	190	230	270	310	...	...	7
16	..	...	175	220	260	310	350	...	...	7
17	..	...	200	250	295	350	400	450	...	7
18	..	...	225	280	330	390	450	500	...	8
19	..	...	250	310	370	440	500	560	620	8
20	..	...	...	350	420	490	560	630	700	8
21	..	...	...	390	470	550	620	700	780	8
22	..	...	...	440	520	610	690	780	860	9
23	..	...	...	490	580	670	770	860	950	9
24	..	...	...	...	640	740	850	950	1050	10
25	..	...	...	...	710	820	930	1040	1140	10
26	..	...	...	...	780	890	1010	1130	1240	11
27	..	...	...	...	840	960	1090	1220	1340	11
28	..	...	...	...	...	1050	1180	1310	1440	12
29	..	...	...	...	...	1140	1280	1410	1550	12
30	..	...	...	...	...	1230	1380	1520	1670	13
31	..	...	...	...	...	...	1480	1630	1780	13
32	..	...	...	...	...	...	1580	1740	1900	14
33	..	...	...	...	...	...	1690	1860	2030	15
34	..	...	...	...	...	...	...	1980	2160	16
35	..	...	...	...	...	...	...	2110	2200	17
36	..	...	...	...	...	...	...	2230	2340	18

Based on 614 trees cut in Alabama scaled as a rule in 16-foot logs. Height of stump equal diameter breast-high. By Franklin B. Reed of the U. S. Forest Service. Shortleaf pine, as shown by other work of the Service, follows Longleaf closely.

VOLUME TABLE No. 19. LOBLOLLY PINE, BY THE SCRIBNER RULE

(Ashe in Bulletin No. 24, N. C. Geological and Economic Survey)

Diameter breast- high	Total Height of Tree—Feet											Diameter inside bark at top
	40	50	60	70	80	90	100	110	120	130	140	
Inches	Contents—Board Feet											Inches
8	5	13	21	27	...	...	...	...	...	...	...	5
9	12	22	32	42	52	...	...	...	...	...	...	6
10	18	30	42	55	65	...	...	...	...	...	...	6
11	25	40	54	68	81	93	...	...	...	...	...	6
12	32	50	66	83	99	110	130	140	150	...	...	7
13	40	60	81	100	120	140	160	170	180	...	...	7
14	..	70	97	120	150	180	200	220	240	...	...	8
15	..	..	110	140	170	210	230	260	290	...	...	8
16	..	..	120	160	200	240	270	300	330	...	...	8
17	..	..	..	190	230	270	310	350	380	...	...	8
18	..	..	..	220	270	310	360	400	440	...	...	9
19	..	..	..	..	300	360	410	460	500	530	...	9
20	..	..	..	..	330	410	470	520	570	610	...	9
21	..	..	..	..	..	460	530	590	640	690	...	10
22	..	..	..	..	..	510	600	660	720	780	...	10
23	..	..	..	..	..	570	660	740	810	870	...	10
24	..	..	..	..	..	620	730	820	900	960	1020	11
25	..	..	..	..	..	..	810	910	990	1060	1130	11
26	..	..	..	..	..	..	890	990	1090	1170	1240	11
27	..	..	..	..	..	..	970	1090	1190	1280	1350	12
28	..	..	..	..	..	..	1060	1180	1290	1390	1470	12
29	..	..	..	..	..	..	1150	1280	1400	1500	1590	13
30	..	..	..	..	..	..	1240	1380	1510	1620	1710	13
31	..	..	..	..	..	..	..	1500	1630	1750	1860	13
32	..	..	..	..	..	..	..	1610	1750	1880	1980	14
33	..	..	..	..	..	..	..	1720	1870	2010	2130	14
34	..	..	..	..	..	..	..	1840	2000	2140	2250	15
35	..	..	..	..	..	..	..	..	2130	2270	2380	15
36	..	..	..	..	..	..	..	..	2270	2400	2510	15

Based on measurement of about 3000 trees scaled in 16.3 foot log lengths (with some shorter logs to avoid waste) from a stump 1 or 1.5 foot high to top diameters stated. Allowance made for normal but not excessive crook, and not for defect or breakage. With the same outside dimensions younger trees yield slightly less than old ones: 40 to 45 year old trees yield about 10% less than above figures.

## NOTES ON WESTERN VOLUME TABLES

The tables which follow are representative and the most reliable in existence; all are in use in work of importance. No one, however, either East or West, should harbor the idea that such tables will work his salvation.

Few will require caution as to the difference between log scale and saw product. It is well understood that defect has to be specially allowed for. The big part breakage plays in the yield of Coast timber was emphasized in earlier pages.

The fact that trees may have been scaled for a volume table by a scale rule different from the one by which timber in question is actually to be scaled will be considered of consequence only if the two rules vary enough to signify among the inevitable errors of estimating. If that is the case a comparison should be worked out, not a difficult undertaking. Then varying practice in application of the scale rule itself might make noticeable difference. The general conclusion is that, before trusting any volume table on responsible work, the cruiser had better test it to see how it fits his timber and practice.

Further, it is indispensable, when such tables are relied on, that the exact nature of the table itself should be understood and field practice governed accordingly. Three different kinds of tables are, in fact, represented.

In No. 23, for lodgepole pine, total height of the tree is used as the basis of height classification. Some men will find it strange to work in that dimension; it is habitual with others, however. The general reliability of tables of this kind was discussed on pages 170 and 171, and it is necessary here to add only a suggestion on the head of timber utilization. When the table in question was made up, the logs were scaled to a diameter of 6 inches at the top. If actual utilization in a given locality falls short of that, a very few measurements on down trees will enable a man to make proper deduction. If, for instance, actual utilization of lodgepole pine should fall one log length lower than the standard, a 6-inch 16-foot log,

scaling 18 feet by the Scribner rule, may be deducted from the tabular values. It is not a large percentage of sizable timber. If logs are cut and scaled in longer lengths than 16 feet, adjustment may be made on somewhat the same plan, as explained on pages 172 and 173. This last adjustment may be made in any kind of table.

In most of the western tables total height is neglected and the trees are classified by number of merchantable log lengths. That follows the usual practice in western cruising, practice connected apparently with the great height of the timber. There are, however, two types of tables in this class — those in which the timber is scaled up to a single fixed diameter and those in which the top diameter varies with actual utilization. Nos. 28 and 22, tables for Washington hemlock and for yellow pine of the Southwest, illustrate these two types.

The chances of error in connection with tables of the type of No. 22 (leaving out of account now individual variation of form) may be illustrated as follows: A tree 31 inches in breast diameter with five 16-foot logs is given a volume of 1410 feet and the figure is based (see table 21) on utilization to a 13-inch top limit. If very close utilization should secure another log length above that, the fact would not greatly concern an estimator because it would be so small in volume proportionally. Even if one less log were taken out than the table contemplates, it would amount to but 97 feet, 7 per cent of the tabular volume. What is of more importance, however, is that the height at which the tree reaches 13 inches diameter be estimated correctly. Should this height be set a log length too low and the tree scored down as of four logs instead of five, the value derived from the table would be 1230 feet instead of 1410, 13 per cent too little. An error of equal amount results if the tree is scored a log too long.

Tables of the type of No. 28, scaling the logs up to a small diameter uniform in all sizes of timber, present an appearance of greater accuracy, but as a matter of fact much larger errors than the above may arise from care-

less use of such tables. A chief reason is that men tend strongly to tally timber as yielding the log lengths to which they are accustomed in practice, which in the case of large trees departs widely from the theoretical utilization. Thus, a 36-inch 5-log hemlock is given in table 28 as having 3430 feet of timber. In logging, however, somewhere about 128 feet in log lengths would be got out of it. If, then, a cruiser tallied it as a 4-log tree, his table would give him 2530 feet, over 26 per cent less than the true volume. That might indeed in a given case just about make due breakage and defect allowance, but such a result accidentally arrived at is no justification of the practice.

The user of these tables, then, of whatever description, must realize their exact nature and govern his field work accordingly. Judgment also must supplement their use,

Tree No.	Diameter Breast High		Diameter at Top of Log (32 Feet)					Contents by Decimal Rule
	Outside Bark	Inside Bark						
	Inches	Inches	1	2	3	4	5	Feet
1	27	23	19	16	13	10	..	1,110
2	38	32	26	23	20	15	..	2,590
3	53	45	36	32	27	21	..	5,030
4	84	74	62	57	51	46	36	19,570
5	..	23	18	15	11	..	..	850
6	..	23	20	18	16	15	12	1,750
7	26	24	20	17	14	8	..	1,290
8	39	36	31	28	24	17	..	2,760
9	46	43	36	31	26	19	10	4,870
10	51	48	41	37	32	24	12	7,040
11	..	48	43	39	34	25	11	7,690
12	..	48	40	37	32	21	11	6,760
13	..	30	27	25	21	12	..	2,790
14	..	30	25	23	19	12	..	2,310
15	..	74	63	60	46	41	..	17,090
16	..	73	54	48	45	40	..	13,280

and some men, having arrived at direct, first-hand grasp of timber quantity, find tables of use only incidentally.

On pages 196 to 197 volume tables produced by scaling logs decreasing by a regular taper, as if trees were conical in form, were referred to as in wide use in Oregon

and Washington. In the application of these to standing timber somewhat the same difficulties are met as above, while others arise due to the fact that only a very unusual tree throughout its merchantable length has a true taper. Normal and also unusual relations in northwestern trees are illustrated above. The inference is easy that tables of the kind mentioned are best left to the use of experts.

The first four of the above sets of figures, for Douglas fir, represent normal form. The body of the tree is seen to have less taper than either the butt log or the top; the larger the tree's diameter the faster the taper normally, and that shows in the butt log particularly. On this last fact rests the practice of cruisers of taking base diameter pretty high usually and frequently discounting the diameter ascertained by measure. Their effort really is to line the basal diameter with that at the top of the first log and those above it.

Trees No. 5 and 6 are representative of quick and slow taper, or what amounts to the same thing, of short and tall timber. On the same base diameter one tree has twice the contents of the other. No. 6 is a tree of very unusual taper, however.

Other northwestern species, with the exception of cedar, have form in general similar to fir, but a much thinner bark, as Nos. 7 to 10, for hemlock and noble fir, illustrate. Very heavy taper high up in the trees is also shown here. The bearing of this last fact on the applicability of a straight-taper volume table is illustrated below from tree No. 10 in the series. (See also discussion on pages 196 and 197.) The error in one case is 3 per cent, the other 15 per cent. This last error is seen to be incurred by inclusion in the reckoning of a log that contains only 2 per cent of the volume of the tree, and that likely to be broken up in felling. The practice of commercial cruisers in neglecting the contents of trees above a diameter equal about half the base diameter is thus rationalized.

Contents of 4 lower logs, actual taper . . . . .	6880 feet
Contents of 4 lower logs, regular taper . . . . .	6660 feet
Contents of 5 logs, actual taper . . . . .	7040 feet
Contents of 5 logs, regular taper . . . . .	5960 feet
Contents of fifth log . . . . .	160 feet

The remaining figures illustrate variation of form and irregularity. Nos. 11 and 12, having the same diameter breast high and also at the top of the logs used, are yet 13 per cent apart in contents, while the second pair of matched trees differ by .19 per cent, of the average value in each case. The taper of the body of these trees is regular, however; the variation is in the butt and top log sections, the former being far more significant. Trees Nos. 15 and 16 show some real irregularity, though nothing extreme. Much wider departures from type than any of these could in fact be chosen.

In conclusion, a contrast will be drawn between present commercial methods and the use of volume tables. In the construction of these it is customary to throw out swell butt and other abnormality of form, and, that done, the tables derive strength from the law of averages. Single trees may depart from the type and a certain amount of variation goes with age, but the table, based on a large number of trees and applied to large numbers, *if that is done in the same way the measures behind the table were taken*, gives results that are trustworthy within reasonable limits. Present-day commercial estimates may be equally correct, but that depends on a different thing — on the ability of the cruiser to size up each tree as seen, on the basis of his training of every description.

VOLUME TABLE No. 20. WESTERN WHITE PINE, IN BOARD FEET, BY THE SCRIBNER RULE

(From Bulletin No. 36, U. S. Forest Service)

Diameter breast- high	Number of Sixteen-Foot Logs									Basis
	2	3	4	5	6	7	8	9	10	
Inches	Volume — Board Feet									Trees
8	40	60	85	105	...	...	...	...	...	7
9	45	70	95	120	...	...	...	...	...	40
10	55	85	110	140	165	...	...	...	...	65
11	65	95	125	160	190	...	...	...	...	76
12	75	110	145	180	215	245	...	...	...	104
13	..	125	165	200	240	280	...	...	...	76
14	..	145	190	230	270	320	360	...	...	107
15	..	165	215	260	310	360	400	...	...	86
16	..	185	235	290	340	400	450	...	...	80
17	..	...	255	320	380	450	510	570	...	104
18	..	...	275	350	420	500	570	640	...	111
19	..	...	295	380	460	550	630	720	...	117
20	..	...	320	410	500	600	690	790	880	115
21	..	...	...	430	540	650	760	870	980	103
22	..	...	...	460	580	710	830	960	1080	94
23	..	...	...	480	620	760	910	1050	1190	83
24	..	...	...	510	660	820	980	1140	1300	81
25	..	...	...	...	710	890	1060	1240	1410	69
26	..	...	...	...	760	950	1140	1330	1520	64
27	..	...	...	...	810	1010	1220	1430	1630	65
28	..	...	...	...	...	1080	1300	1530	1750	40
29	..	...	...	...	...	1150	1390	1630	1870	23
30	..	...	...	...	...	1220	1470	1730	1990	28
31	..	...	...	...	...	...	1550	1830	2110	14
32	..	...	...	...	...	...	1630	1930	2230	9
33	..	...	...	...	...	...	1710	2030	2360	14
34	..	...	...	...	...	...	...	2140	2490	6
35	..	...	...	...	...	...	...	2250	2630	6
36	..	...	...	...	...	...	...	2360	2770	4
										1791

From timber grown in northern Idaho.

Trees scaled to a top diameter inside bark of 6 to 8 inches. Height of stump — 2 to 3 feet. All trees scaled as though sound. Loss by breakage was 4 per cent. Loss due to invisible rot was 5 per cent.

VOLUME TABLE No. 21. WESTERN YELLOW PINE IN  
BOARD FEET, BY THE SCRIBNER RULE

(From Bulletin No. 36, U. S. Forest Service)

Diam- eter breast- high  Inches	Height of Tree-Feet									Diam- eter of top in- side bark  Inches	Basis  Trees
	40	50	60	70	80	90	100	110	120		
12	50	60	70	80	...	...	...	...	...	8.3	..
13	60	80	90	100	...	...	...	...	...	8.5	23
14	70	90	110	120	140	150	...	...	...	8.7	48
15	90	110	130	150	170	180	190	...	...	8.9	91
16	110	130	160	180	200	220	230	240	...	9.2	117
17	130	160	180	210	230	260	280	290	310	9.4	142
18	160	180	210	240	270	300	320	350	370	9.6	136
19	180	210	250	280	310	350	380	410	430	9.9	135
20	210	250	280	320	360	400	440	470	500	10.1	104
21	240	280	320	370	410	460	500	540	580	10.4	127
22	280	310	360	410	470	520	570	620	670	10.6	135
23	...	350	410	470	520	590	640	700	760	10.9	103
24	...	390	450	520	590	660	720	780	850	11.1	105
25	...	430	500	580	650	730	800	880	950	11.3	85
26	...	470	550	630	720	800	890	980	1070	11.6	93
27	...	...	610	690	790	880	980	1080	1190	11.9	83
28	...	...	660	760	860	960	1080	1190	1310	12.1	63
29	...	...	...	820	930	1040	1170	1300	1440	12.4	51
30	...	...	...	880	1000	1130	1270	1420	1570	12.7	42
31	...	...	...	940	1070	1220	1380	1550	1720	12.9	21
32	...	...	...	1010	1150	1310	1490	1680	1870	13.2	28
33	...	...	...	...	1230	1410	1610	1820	2020	13.5	22
34	...	...	...	...	1310	1510	1740	1960	2180	13.9	22
35	...	...	...	...	1390	1620	1870	2110	2330	14.3	17
36	...	...	...	...	1470	1720	1990	2260	2500	14.7	13
37	...	...	...	...	...	1810	2120	2410	2660	15.2	6
38	...	...	...	...	...	1900	2250	2550	2820	15.8	4
39	...	...	...	...	...	...	2390	2690	2980	16.4	5
40	...	...	...	...	...	...	2530	2840	3150	17.0	1
1822											

Measurements by T. S. Woolsey, Jr., in Arizona.

Trees scaled to 8-inch top inside bark — straight and sound. Allow 3 to 15 per cent for defects. The so-called “black jack” variety requires a further reduction of about 12 per cent, having a smaller volume than the older “yellow pine.”

VOLUME TABLE No. 22. WESTERN YELLOW PINE, BY THE SCRIBNER RULE

Same trees classified by 16-foot log lengths

Diameter breast-high	Number of 16-foot Logs						Basis
	1	2	3	4	5	6	
Inches	Volume — Board Feet						Trees
13	50	80	...	...	...	....	22
14	60	100	140	190	...	....	47
15	70	120	160	210	...	....	93
16	80	140	180	240	...	....	119
17	100	160	210	270	...	....	142
18	120	190	240	310	380	....	140
19	140	220	270	350	430	....	138
20	160	250	310	400	490	....	108
21	...	290	360	450	550	....	128
22	...	330	410	500	610	....	136
23	...	380	460	560	680	....	101
24	...	420	520	630	760	....	108
25	...	470	580	700	840	....	86
26	...	530	640	780	920	1060	95
27	...	580	710	860	1010	1150	85
28	...	630	790	950	1100	1250	65
29	...	...	870	1040	1200	1360	54
30	...	...	960	1130	1300	1470	43
31	...	...	1050	1230	1410	1590	25
32	...	...	1140	1340	1530	1710	28
33	...	...	1240	1460	1660	1830	21
34	...	...	1340	1580	1780	1960	21
35	...	...	...	1710	1910	2090	14
36	...	...	...	1830	2040	2220	12
37	...	...	...	1950	2160	2340	5
38	...	...	...	2060	2280	2450	3
39	...	...	...	2160	2400	2560	3
40	...	...	...	2260	2520	2670	2
							1844

The values in this table are materially higher than those of other Forest Service tables for the same species made in California and Oregon.

VOLUME TABLE No. 23. LODGEPOLE PINE, IN BOARD FEET, BY THE SCRIBNER RULE

(From Bulletin No. 36, U. S. Forest Service)

Diameter breast-high Inches	Total Height of Tree — Feet						Basis Trees
	50	60	70	80	90	100	
10	50	65	75	90	105	125	495
11	60	75	90	105	125	155	478
12	75	90	105	125	150	185	296
13	90	105	125	145	180	215	146
14	105	125	145	170	215	250	120
15	...	140	170	200	250	285	113
16	...	160	195	230	285	315	60
17	...	...	225	260	315	350	44
18	...	...	250	290	350	385	25
19	...	...	275	320	380	420	17
20	...	...	300	345	415	460	14

Figures by Tower and Redington from trees cut in Gallatin County, Montana. Trees scaled in logs 10 to 16 feet long up to 6 inches in top.

YIELD OF LODGEPOLE PINE IN RAILROAD TIES

(From Study by Students of University of Washington)

Diameter breast-high Inches	Average Number Obtained per Tree					
	Hewn Ties			Sawed Ties		
	Tall over 80'	Medium 60-80'	Short under 60'	Tall over 80'	Medium 60-80'	Short under 60'
10	1.7	1.5	1.1	...	...	...
11	3.0	2.7	1.8	0.9	0.8	0.7
12	4.0	3.5	2.2	1.9	1.7	1.2
13	4.9	4.0	2.5	3.0	2.6	1.8
14	5.5	4.4	2.7	3.9	3.3	2.2
15	6.0	4.7	2.9	4.6	3.8	2.5
16	6.4	5.0	...	5.1	4.2	...
17	6.7	5.0	...	5.5	4.2	...
18	6.9	5.0	...	5.9	4.2	...
19	7.1	...	...	6.1	...	...
20	7.2	...	...	6.3	...	...

Results from 267 trees cut in eastern Oregon: Hewn ties from timber not less than 8½ inches in diameter, made 7 inches thick; sawed ties, 6 by 8 inches; both kinds, 8 feet long. Average height of 10-inch trees, 68 feet; of 15-inch trees, 85 feet; of 20-inch trees, 93 feet.

VOLUME TABLE No. 24. WESTERN LARCH, IN BOARD FEET,  
BY THE SCRIBNER RULE

(From Bulletin No. 36, U. S. Forest Service)

Diam- eter breast- high  Inches	Number of 16-Foot Logs						Diam- eter of top inside bark  Inches	Basis  Trees
	3	4	5	6	7	8		
11	95	140	...	...	...	....	...	3
12	105	155	...	...	...	....	7.3	15
13	120	165	220	...	...	....	7.4	31
14	135	185	240	...	...	....	7.5	93
15	155	205	270	...	...	....	7.6	114
16	175	230	295	380	...	....	7.7	119
17	195	260	325	415	...	....	7.8	128
18	220	285	365	455	...	....	7.9	100
19	240	315	400	490	...	....	8.0	93
20	265	345	435	535	645	...	8.1	127
21	...	380	475	585	705	...	8.1	86
22	...	415	520	635	775	...	8.1	89
23	...	450	560	695	840	1005	8.2	80
24	...	485	605	745	905	1085	8.2	79
25	...	525	655	805	975	1180	8.2	52
26	...	565	700	865	1055	1275	8.2	32
27	...	605	755	930	1130	1375	8.3	32
28	...	650	805	995	1210	1470	8.3	35
29	...	...	855	1060	1295	1565	8.4	17
30	...	...	910	1130	1385	1670	8.5	21
31	...	...	...	1205	1465	1770	8.7	12
32	...	...	...	1280	1560	1875	8.8	10
33	...	...	...	1360	1650	1975	9.0	4
34	...	...	...	1440	1745	2085	9.2	8
35	...	...	...	1525	1845	2190	9.4	1
36	...	...	...	1600	1945	2295	9.6	5
37	...	...	...	1685	2040	2395	9.8	3
38	...	...	...	1770	2145	2505	10.0	2
39	...	...	...	1850	2240	2610	10.2	...
40	...	...	...	1930	2340	2715	10.4	...
								1391

Above table by L. Margolin from timber cut in Flat-head County, Montana. Trees scaled without allowance for breakage and defect, which in this timber amounted to 5 per cent. In addition 5 per cent or more should be allowed for "butts" left if logs are driven.

## VOLUME TABLE No. 25. ENGELMANN SPRUCE, IN BOARD FEET, BY THE SCRIBNER RULE

(From Bulletin No. 36, U. S. Forest Service)

Diameter breast- high  Inches	Height of Tree — Feet									Diameter of top inside bark  Inches	Basis  Trees
	40	50	60	70	80	90	100	110	120		
8	15	20	30	..	..	...	...	...	...	6.2	8
9	15	25	35	50	70	...	...	...	...	6.3	19
10	20	30	45	60	80	...	...	...	...	6.4	19
11	25	40	55	70	90	110	...	...	...	6.5	35
12	30	50	65	85	110	135	...	...	...	6.6	45
13	40	60	80	100	130	160	...	...	...	6.7	44
14	50	70	95	120	150	185	220	...	...	6.8	51
15	60	80	110	140	170	210	250	...	...	6.9	37
16	70	95	125	160	190	240	280	340	...	7.0	61
17	..	110	140	180	220	270	320	380	...	7.1	57
18	..	125	160	200	250	300	360	430	...	7.1	55
19	..	...	180	225	280	330	400	470	...	7.2	45
20	..	...	205	250	310	360	440	520	600	7.2	43
21	..	...	230	280	340	400	480	560	650	7.3	41
22	..	...	250	310	370	440	520	610	700	7.4	29
23	..	...	...	340	400	480	560	660	760	7.4	21
24	..	...	...	370	430	520	600	710	820	7.5	21
25	..	...	...	...	470	560	650	760	880	7.5	10
26	..	...	...	...	500	600	700	820	950	7.6	11
											652

From trees cut in Colorado and Utah measured by H. D. Foster. Stump height  $1\frac{1}{2}$ –3 feet.

VOLUME TABLE No. 26. DOUGLAS FIR OF THE COAST  
 BY THE SCRIBNER DECIMAL RULE  
 (U. S. Forest Service)

Diameter at Stump Outside Bark	Average	Number of Thirty-two-Foot Logs											
		1½	2	2½	3	3½	4	4½	5	5½	6	6½	7
Inches	Volume — Board Feet in Tens												
18	40	28	34	41	50	58	...	...	...	...	...	...	...
20	50	32	39	47	56	65	...	...	...	...	...	...	...
22	62	..	44	53	66	78	92	...	...	...	...	...	...
24	77	..	49	60	75	88	102	...	...	...	...	...	...
26	91	..	55	68	84	98	112	122	...	...	...	...	...
28	105	..	61	76	95	110	124	136	...	...	...	...	...
30	125	..	66	84	106	124	141	157	...	...	...	...	...
32	145	..	..	92	115	138	162	182	...	...	...	...	...
34	169	..	..	100	125	149	176	203	...	...	...	...	...
36	195	..	..	120	138	164	192	227	247	...	...	...	...
38	228	..	..	..	..	183	212	253	278	...	...	...	...
40	270	..	..	..	..	..	228	280	313	...	...	...	...
42	312	..	..	..	..	..	246	306	342	385	437	...	...
44	365	..	..	..	..	..	268	332	374	420	462	...	...
46	425	..	..	..	..	..	286	358	403	454	494	...	...
48	480	..	..	..	..	..	..	388	433	487	534	592	...
50	535	..	..	..	..	..	..	420	468	528	581	644	...
52	588	..	..	..	..	..	..	450	502	566	598	680	730
54	645	..	..	..	..	..	..	480	530	595	654	722	774
56	705	..	..	..	..	..	..	..	..	630	697	771	830
58	765	..	..	..	..	..	..	..	..	668	744	821	888
60	830	..	..	..	..	..	..	..	..	711	790	872	942
62	900	..	..	..	..	..	..	..	..	760	838	926	1009
64	972	..	..	..	..	..	..	..	..	808	886	985	1082
66	1048	..	..	..	..	..	..	..	..	864	953	1066	1171
68	1133	..	..	..	..	..	..	..	..	..	1030	1147	1261
70	1226	..	..	..	..	..	..	..	..	..	1118	1225	1345
72	1310	..	..	..	..	..	..	..	..	..	1198	1312	1420
74	1413	..	..	..	..	..	..	..	..	..	1285	1390	1486
76	1515	..	..	..	..	..	..	..	..	..	1364	1465	1556

Based on 1394 trees measured in logging operations in Lane County, Oregon. Diameters, taken outside bark, on the stump, which was ordinarily about 4 feet high, are closely comparable with the diameter at breast height. Trees scaled without deduction for defect or breakage, to a point 10 inches in diameter at the top, unless unmerchantable to this point. The majority of the logs were 24 feet long, though the length varied from 16 to 36 feet.

VOLUME TABLE No. 27. DOUGLAS FIR OF THE INTERIOR  
IN BOARD FEET, BY THE SCRIBNER RULE

(From Bulletin No. 36, U. S. Forest Service)

Diameter breast- high	Total Height of Tree — Feet						Diameter of top inside bark	Basis
	60	70	80	90	100	110		
8	20	30	..	...	...	...	6.2	1
9	30	40	60	...	...	...	6.3	7
10	40	60	70	...	...	...	6.5	4
11	60	70	90	110	...	...	6.6	23
12	70	90	110	130	...	...	6.7	53
13	90	110	130	160	190	...	6.8	57
14	100	130	150	180	220	...	6.9	51
15	120	150	170	210	250	...	7.0	55
16	140	170	200	240	290	...	7.2	59
17	150	190	230	270	320	...	7.3	51
18	170	220	250	300	360	400	7.4	64
19	190	240	280	330	400	450	7.5	57
20	210	270	320	370	440	500	7.6	55
21	230	300	350	410	480	550	7.8	57
22	250	330	380	450	530	600	7.9	50
23	...	360	420	490	580	650	8.0	45
24	...	390	450	540	630	710	8.2	40
25	...	420	490	580	690	770	8.3	38
26	...	450	530	630	750	830	8.5	31
27	...	480	580	680	810	900	8.6	22
28	...	520	620	730	870	970	8.8	12
29	...	...	670	790	940	1040	8.9	9

From timber cut in Wyoming and Idaho measured by  
Messr. Redington and Peters.

VOLUME TABLE No. 28. WASHINGTON HEMLOCK BY THE SCRIBNER DECIMAL RULE

(By E. J. Hanzlik of U. S. Forest Service)

Diameter Breast, High Outside Bark	Average	Number of Thirty-two-Foot Logs								
		1½	2	2½	3	3½	4	4½	5	5½
Inches	Volume — Board Feet in Tens									
12	14	16	21	...	...	...	...	...	...	...
13	20	17	23	28	32	...	...	...	...	...
14	26	18	26	31	37	44	...	...	...	...
15	32	19	29	35	42	49	...	...	...	...
16	39	21	32	39	47	55	...	...	...	...
17	46	23	35	43	52	61	...	...	...	...
18	53	26	39	47	58	68	78	...	...	...
19	62	..	42	52	64	76	87	...	...	...
20	70	..	46	57	71	84	96	...	...	...
21	80	..	50	62	77	91	104	...	...	...
22	90	..	54	67	84	100	112	140	...	...
23	100	..	57	73	90	108	122	148	...	...
24	111	..	..	80	96	116	130	156	...	...
25	122	..	..	86	104	124	139	165	...	...
26	134	..	..	92	112	133	148	174	...	...
27	146	..	..	100	120	141	158	184	...	...
28	158	..	..	106	128	149	167	193	226	...
29	170	..	..	113	139	158	177	204	237	...
30	183	..	..	121	147	168	186	214	248	...
31	197	..	..	...	156	177	197	226	260	...
32	212	..	..	...	165	186	208	238	274	...
33	228	..	..	...	173	195	219	250	288	...
34	245	..	..	...	181	204	229	263	305	353
35	264	..	..	...	190	213	242	278	323	376
36	284	..	..	...	...	222	253	293	343	404
37	304	..	..	...	...	231	266	310	366	436
38	326	..	..	...	...	240	280	330	393	477
39	346	..	..	...	...	250	294	351	424	519
40	368	..	..	...	...	259	308	378	460	561

Based on 1440 trees, in both pure and mixed stands, measured at logging operations at various points in western Washington. A stump height equal breast diameter allowed. Trees scaled in 16-foot log lengths (with trimming allowance) to a diameter inside bark of 8 inches. No deduction for defect or breakage.

Actual utilization a little over 80 per cent of above figures.

The true firs are formed very nearly like hemlock.

VOLUME TABLES No. 29. WASHINGTON RED CEDAR  
BY THE SCRIBNER DECIMAL RULE

## TALL TIMBER

Diameter Breast High Outside Bark	First 32' Log			Second 32' Log			Third Log Diam.	Fourth Log Diam.	Total Contents Feet
	Top Diam.	Scale	% of Total	Top Diam.	Scale	% of Total			
16	11	140	70	7	60	30	..	..	200
18	12	160	70	8	70	30	..	..	230
20	13	190	61	10	120	39	..	..	310
22	14	230	62	11	140	38	..	..	370
24	16	320	67	12	160	33	..	..	480
26	17	370	59	13	190	30	11( $\frac{1}{2}$ )	..	630
28	18	430	55	14	230	30	10	..	780
30	19	480	53	15	280	31	11	..	900
32	21	610	56	16	320	29	12	..	1090
34	22	670	51	17	370	28	13	11( $\frac{1}{2}$ )	1300
36	23	750	50	18	430	28	14	12( $\frac{1}{2}$ )	1490
38	24	810	48	19	480	28	15	10	1690
40	25	920	47	20	560	29	16	11	1940
42	27	1100	49	21	610	27	17	11	2220
44	28	1160	46	23	750	29	18	12	2500
46	29	1220	44	24	810	29	19	13	2700
48	30	1310	42	25	920	30	20	14	3000
50	31	1420	42	26	1000	30	21	15	3300

The above and following table are based on field measurements of about 1200 sound and normal trees grown in fully stocked mixed stands in the Puget Sound region, at elevations from 200 to 1000 feet, by A. G. Jackson of the U. S. Forest Service. Scaled from taper measurements in 32-foot logs to diameters stated. Data arranged to promote timber grading.

Cedar scaled in short lengths, if at the same time it is sound, of good form, and fully utilized, will yield more than these values. On the other hand the tree is so largely subject to swell butt, rot and breakage, that tables must be used with great caution and often discarded altogether.

SHORTER TIMBER

Diameter Breast High Outside Bark	First 32' Log			Second 32' Log			Third Log Diam.	Fourth Log Diam.	Total Volume Feet
	Top Diam.	Scale	% of Total	Top Diam.	Scale	% of Total			
16	10	120	70	6	50	30	..	..	170
18	11	140	70	7	60	30	..	..	200
20	12	160	70	8	70	30	..	..	230
22	13	190	68	9	90	32	..	..	280
24	14	210	69	10	120	31	..	..	330
26	15	280	67	11	140	33	..	..	420
28	17	370	70	12	160	30	..	..	530
30	18	430	63	13	190	28	10( $\frac{1}{2}$ )	..	680
32	19	480	61	14	230	29	12( $\frac{1}{2}$ )	..	790
34	20	560	58	15	280	32	10	..	960
36	22	670	57	17	370	31	11	..	1180
38	23	750	55	18	430	33	12	..	1340
40	24	810	55	19	480	32	13	..	1480
42	25	920	50	20	560	31	15	11( $\frac{1}{2}$ )	1830
44	27	1100	52	21	610	29	16	12( $\frac{1}{2}$ )	2110
46	28	1160	48	23	750	31	17	11	2420
48	29	1220	47	24	810	31	18	12	2620
50	30	1310	45	25	920	32	19	13	2900

The trees in this table are really of good length. Measurements on short mountain timber are not available.

Cedar Shingle Bolts. Very defective trees, the breakage of logging operations, and sometimes the whole usable contents of trees above about 20 inches in breast diameter are largely utilized in this form. The bolts are cut 52 inches long and the larger pieces split; they are then piled and measured in the cord 8 x 4 feet. In present practice from 18 to 25 bolts make a cord which careful measurement has shown to contain of solid wood about 70 per cent of its outside contents. A cord is equivalent to from 500 to 700 feet log scale, less in the smaller sizes of timber.

VOLUME TABLE No. 30. SUGAR PINE IN CALIFORNIA  
BY THE SCRIBNER DECIMAL RULE

(U. S. Forest Service)

Diameter Breast- high	Number of Sixteen-Foot Logs											Diameter Inside Bark of Top	Basis Trees
	2	3	4	5	6	7	8	9	10	11	12		
Inches	Volume — Board Feet in Tens											Inches	
12	9	15	22	..	..	..	..	..	..	..	..	8	..
14	10	17	24	..	..	..	..	..	..	..	..	8	1
16	10	19	27	39	..	..	..	..	..	..	..	8	2
18	13	20	30	43	..	..	..	..	..	..	..	9	7
20	17	25	37	50	65	79	..	..	..	..	..	9	28
22	..	31	43	57	74	89	..	..	..	..	..	9	23
24	..	40	53	67	83	100	122	..	..	..	..	9	35
26	..	50	64	78	96	113	136	..	..	..	..	9	35
28	..	63	78	92	110	128	152	..	..	..	..	10	44
30	..	80	94	108	125	144	170	189	..	..	..	10	53
32	..	..	113	127	145	163	192	218	..	..	..	10	50
34	..	..	135	149	166	187	217	247	..	..	..	10	38
36	..	..	160	173	191	213	246	279	310	..	..	11	36
38	..	..	183	200	220	245	278	313	346	..	..	11	40
40	..	..	210	229	253	280	313	349	386	..	..	11	41
42	..	..	240	261	288	319	354	390	427	463	..	11	43
44	..	..	271	295	325	359	398	435	473	515	..	12	39
46	..	..	303	330	365	401	445	482	523	567	..	12	31
48	..	..	337	366	405	446	493	532	575	623	..	12	43
50	..	..	..	401	446	493	544	586	630	681	749	12	41
52	..	..	..	438	489	544	598	642	686	740	818	12	56
54	..	..	..	472	532	597	653	698	742	801	885	13	36
56	..	..	..	..	575	652	711	756	800	862	953	13	25
58	..	..	..	..	619	709	769	814	860	923	1022	13	25
60	..	..	..	..	660	764	829	872	921	987	1090	14	28
62	..	..	..	..	704	820	886	930	983	1051	1159	14	25
64	..	..	..	..	..	876	943	990	1046	1116	1227	14	27
66	..	..	..	..	..	933	1000	1053	1109	1181	1297	14	11
68	..	..	..	..	..	989	1058	1115	1173	1250	1366	15	9
70	..	..	..	..	..	1048	1117	1177	1239	1319	1434	15	17
73	..	..	..	..	..	..	1176	1240	1305	1388	1502	15	6
74	..	..	..	..	..	..	1235	1303	1370	1456	1570	16	2
76	..	..	..	..	..	..	1296	1368	1435	1523	1639	16	6
78	..	..	..	..	..	..	1358	1431	1500	1590	1707	16	4
80	..	..	..	..	..	..	1420	1497	1565	1659	1778	16	3
..	..	..	..	..	..	..	..	..	..	..	..	..	910

Average stump heights 1.3 to 3.1 feet.  
Logs scaled in commercial lengths as cut.

## SECTION III

### MISCELLANEOUS TABLES AND INFORMATION

1. RULES FOR AREA AND VOLUME OF DIFFERENT FIGURES . . . . .	294
2. WEIGHT OF MATERIALS . . . . .	296
3. HANDY EQUIVALENTS . . . . .	297
4. NUMBER OF PLANTS PER ACRE WITH DIFFERENT SPACING . . . . .	297
5. COMPOUND INTEREST TABLE . . . . .	298
6. TIME IN WHICH A SUM WILL DOUBLE . . . . .	298
7. TABLE OF WAGES AT GIVEN RATES PER MONTH . . . . .	299
8. THE BILTMORE STICK . . . . .	301

## RULES FOR AREA AND VOLUME OF DIFFERENT FIGURES

**Area of Square.** Multiply the length of side by itself, or, as is said, "square" it.

**Area of Rectangle.** Multiply the base by the altitude.

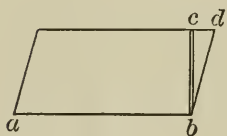

FIGURE A

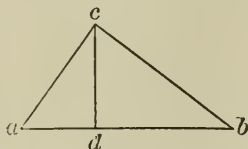

FIGURE B

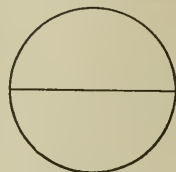

FIGURE C

**Area of Parallelogram.** (Figure A.) Multiply base  $a b$  by altitude  $b c$ , not by  $b d$ . If  $b d$  and the angle at  $d$  are known,  $b c$  may be found by the formula

$$bc = bd \times \text{sine of angle at } d.$$

**Area of Triangle.** (Figure B.) Multiply base  $a b$  by altitude  $c d$  and divide by 2.

**Area of Triangle with 3 Sides Given.** (Figure B.) Add the 3 sides together and divide the sum by 2. From this half sum take each side in succession. Multiply the half sum and the remainders all together and take the square root. The formula is

$$\sqrt{\frac{1}{2} s (\frac{1}{2} s - a) (\frac{1}{2} s - b) (\frac{1}{2} s - c)}$$

**Circle.** Circumference equals diameter  $\times 3.1416$ .

**Area of Circle.** (Figure C.) Square the diameter, multiply by 3.1416, and divide by 4.

**Right-Angled Triangle.** The square of the hypotenuse of a right-angled triangle equals the sum of the squares on the other two sides, or, in the figure,

$$AB^2 + AC^2 = BC^2,$$

or  $O + N = M.$

By means of this rule, when any two sides of a right-angled triangle are given, the third can be found.

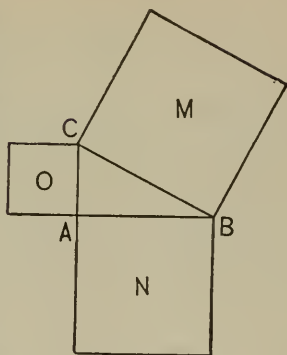

FIGURE D

**Volume of Cylinder.** (Figure E.) Multiply the area of the base by the altitude.

**Volume of Cone.** (Figure F.) Multiply the area of the base by one-third of the height.

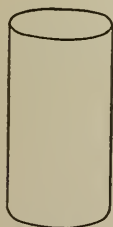

FIGURE E



FIGURE F



FIGURE G



FIGURE H

**Volume of Prism whether Right or Oblique.** (Figure G.) Multiply area of base by the vertical height.

**Volume of Pyramid.** (Figure H.) Multiply base by one-third of the height.

**To Measure the Contents of a Box or Solid with Sides at Right Angles to One Another.** Multiply length by breadth by height. If the dimensions are in feet the result will be the contents in cubic feet.

## WEIGHT OF MATERIALS

A cubic foot of water weighs . . . . .	62½ lbs.
A cubic foot of cast iron weighs about . . . . .	450 lbs.
A cubic foot of wrought iron or steel weighs about . . . . .	480 lbs.

Woods when thoroughly seasoned weigh per cubic foot about as follows. Absolute drying in a kiln will lessen these figures about 10 per cent. Green wood is from 50 to 80 per cent heavier.

White pine, white spruce, balsam fir, aspen . . . . .	27 lbs.
Red spruce, hemlock, poplar . . . . .	30 lbs.
Pitch pine, Norway pine, black spruce, white maple . . . . .	31-35 lbs.
White birch, red maple, tamarack, white ash, yellow birch, red oak . . . . .	40-45 lbs.
Beech, sugar maple . . . . .	about 48 lbs.
White oak, black birch . . . . .	about 52 lbs.

A cord of green spruce pulp wood weighs about 4500 lbs.; fir and white pine a little more. A cord of dry spruce pulp wood weighs 3000 to 3500 lbs. Pine, fir, and poplar are somewhat lighter if in exactly the same moisture condition.

Green hard wood by the cord varies greatly in weight. A cord of white birch spool-wood weighs 6000 to 7000 lbs.; sugar maple and yellow birch are 10 per cent heavier; soft maple, ash, basswood, and poplar are somewhat lighter than white birch. For green split cord wood 4000 to 6000 lbs. are the usual limits of weight. Medium dry birch, beech, and maple, split, 66 per cent solid in the pile, weighs about 3000 lbs. to the cord.

A thousand feet of old growth spruce logs, Androscoggin scale, weighs about 6000 lbs., and this is probably the lower limit for green soft-wood lumber, while southern yellow pine at 8000 to 10,000 lbs. is the limit in the other direction. Between these limits there is wide variation by reason of scale and quality.

Seasoning decreases the weight of timber by 30 to 50 per cent as a rule, and at the same time increases its strength by 50 to 100 per cent.

## HANDY EQUIVALENTS

There are 160 square rods in an acre.

A square acre is 208.71 feet on a side.

118 feet is approximately the radius of a circular acre, 83 feet of a half acre, and 59 feet of a quarter acre.

There are 5280 feet in a mile.

A meter contains 39.37 inches; a kilometer is .62 mile.

A liter contains 61 cubic inches, — nearly the contents of a quart.

A hectare contains 2.47 acres.

A gram weighs 15.432 grains, Troy weight.

A kilogram or kilo contains 2.2 lbs avoirdupois.

There are 231 cubic inches in a U. S. liquid gallon.

There are 2150.42 cubic inches in a U. S. struck bushel.

A horsepower is the work done in lifting 33,000 pounds 1 foot in 1 minute. A flow of 528 cubic feet of water per minute with 1 foot fall generates one horsepower.

A miner's inch is the flow of water through an orifice 1 inch square under a head (in some States) of 6 inches. In California 50 miner's inches equal 1 cubic foot per second, equal 1.9835 acre feet per day, nearly an inch an hour. In some States 40 miner's inches equal this flow.

NO. OF PLANTS PER ACRE WITH  
DIFFERENT SPACING

Spacing	No.
3 × 3 ft.	4840
4 × 4	2720
5 × 5	1740
6 × 6	1210
7 × 7	890
8 × 8	680
9 × 9	538
10 × 10	436

## COMPOUND INTEREST TABLE

Amount of \$1 principal after any number of years and at given rates percent

Yrs.	2%	2½%	3%	3½%	4%	4½%	5%	5½%	6%
1	1.020	1.025	1.030	1.035	1.040	1.045	1.050	1.055	1.060
2	1.040	1.051	1.061	1.071	1.082	1.092	1.103	1.113	1.124
3	1.061	1.077	1.093	1.109	1.125	1.141	1.158	1.174	1.191
4	1.082	1.104	1.126	1.148	1.170	1.193	1.216	1.239	1.262
5	1.104	1.131	1.159	1.188	1.217	1.246	1.276	1.307	1.338
6	1.126	1.160	1.194	1.229	1.265	1.302	1.340	1.379	1.419
7	1.149	1.189	1.230	1.272	1.316	1.361	1.407	1.455	1.504
8	1.172	1.218	1.267	1.317	1.369	1.422	1.478	1.535	1.594
9	1.195	1.249	1.305	1.363	1.423	1.486	1.551	1.619	1.690
10	1.219	1.280	1.344	1.411	1.480	1.553	1.629	1.708	1.791
11	1.243	1.312	1.384	1.460	1.540	1.623	1.710	1.802	1.898
12	1.268	1.345	1.426	1.511	1.601	1.696	1.796	1.901	2.012
13	1.294	1.379	1.469	1.564	1.665	1.772	1.886	2.006	2.133
14	1.320	1.413	1.513	1.619	1.732	1.852	1.980	2.116	2.261
15	1.346	1.448	1.558	1.675	1.801	1.935	2.079	2.233	2.397
16	1.373	1.485	1.605	1.734	1.873	2.022	2.183	2.355	2.540
17	1.400	1.522	1.653	1.795	1.948	2.113	2.292	2.485	2.693
18	1.428	1.560	1.702	1.858	2.026	2.209	2.407	2.622	2.854
19	1.457	1.599	1.754	1.923	2.107	2.308	2.527	2.766	3.026
20	1.486	1.639	1.806	1.990	2.191	2.412	2.653	2.918	3.207
25	1.641	1.854	2.094	2.363	2.666	3.005	3.386	3.813	4.292
30	1.811	2.098	2.427	2.807	3.243	3.745	4.322	4.984	5.744
35	2.000	2.373	2.814	3.334	3.946	4.667	5.516	6.514	7.686
40	2.208	2.685	3.262	3.959	4.801	5.816	7.040	8.513	10.286
45	2.438	3.038	3.782	4.702	5.841	7.248	8.985	11.127	13.765
50	2.692	3.437	4.384	5.585	7.107	9.033	11.467	14.542	18.420

## TIME IN WHICH A SUM WILL DOUBLE

Rate Per cent	Simple Interest	Compound Interest
2	50 years	35 years
2½	40 years	28 years 1 month
3	33 years 4 months	23 years 5½ months
3½	28 years 7 months	20 years 2½ months
4	25 years	17 years 8 months
4½	22 years 2¾ months	15 years 9 months
5	20 years	14 years 2½ months
5½	18 years 7 months	12 years 11½ months
6	16 years 8 months	11 years 11¼ months

Note in above tables that a sum at compound interest doubles when rate of interest  $\times$  number of years equals (very nearly) 71. With this remembered many problems in compound interest can be solved mentally.

TABLE OF WAGES, AT GIVEN RATES PER MONTH  
OF TWENTY-SIX DAYS

D	\$15	\$16	\$17	\$18	\$19	\$20	\$21
1	0.58	0.62	0.66	0.69	0.73	0.77	0.81
2	1.15	1.23	1.31	1.38	1.46	1.54	1.62
3	1.73	1.85	1.96	2.08	2.19	2.31	2.42
4	2.31	2.46	2.62	2.77	2.92	3.08	3.23
5	2.88	3.08	3.27	3.46	3.65	3.85	4.04
6	3.46	3.69	3.92	4.15	4.38	4.62	4.85
7	4.04	4.31	4.58	4.85	5.12	5.38	5.65
8	4.62	4.92	5.23	5.54	5.85	6.16	6.46
9	5.19	5.54	5.88	6.23	6.58	6.92	7.27
10	5.77	6.15	6.54	6.92	7.31	7.69	8.08
11	6.35	6.77	7.19	7.62	8.04	8.46	8.88
12	6.92	7.38	7.85	8.31	8.77	9.23	9.69
13	7.50	8.00	8.50	9.00	9.50	10.00	10.50
14	8.08	8.62	9.15	9.69	10.23	10.77	11.31
15	8.65	9.23	9.81	10.38	10.96	11.54	12.12
16	9.23	9.85	10.46	11.08	11.69	12.31	12.92
17	9.81	10.46	11.12	11.77	12.42	13.08	13.73
18	10.38	11.08	11.77	12.46	13.15	13.85	14.54
19	10.96	11.69	12.42	13.15	13.88	14.62	15.35
20	11.54	12.31	13.08	13.85	14.62	15.38	16.15
21	12.12	12.92	13.73	14.54	15.35	16.16	16.96
22	12.69	13.54	14.38	15.23	16.08	16.92	17.77
23	13.27	14.15	15.04	15.92	16.81	17.69	18.58
24	13.85	14.77	15.69	16.62	17.54	18.46	19.38
25	14.42	15.38	16.35	17.31	18.27	19.23	20.19
26	15.00	16.00	17.00	18.00	19.00	20.00	21.00

D	\$22	\$23	\$24	\$25	\$26	\$27	\$28
1	0.85	0.88	0.92	0.96	1.00	1.04	1.08
2	1.70	1.77	1.85	1.92	2.00	2.07	2.15
3	2.54	2.65	2.77	2.89	3.00	3.11	3.23
4	3.38	3.53	3.69	3.84	4.00	4.15	4.31
5	4.23	4.42	4.62	4.81	5.00	5.19	5.38
6	5.08	5.30	5.54	5.77	6.00	6.23	6.46
7	5.92	6.19	6.46	6.73	7.00	7.27	7.54
8	6.77	7.08	7.38	7.69	8.00	8.30	8.62
9	7.61	7.96	8.31	8.65	9.00	9.34	9.69
10	8.46	8.85	9.23	9.61	10.00	10.38	10.77
11	9.30	9.93	10.15	10.57	11.00	11.42	11.84
12	10.15	10.62	11.08	11.54	12.00	12.46	12.92
13	11.00	11.50	12.00	12.50	13.00	13.50	14.00
14	11.84	12.38	12.92	13.46	14.00	14.54	15.08
15	12.69	13.27	13.85	14.42	15.00	15.58	16.15
16	13.54	14.15	14.77	15.38	16.00	16.61	17.23
17	14.38	15.03	15.70	16.34	17.00	17.65	18.31
18	15.23	15.91	16.62	17.31	18.00	18.68	19.38
19	16.07	16.79	17.54	18.27	19.00	19.72	20.46
20	16.92	17.69	18.46	19.23	20.00	20.76	21.54
21	17.77	18.56	19.38	20.19	21.00	21.80	22.61
22	18.61	19.46	20.31	21.15	22.00	22.84	23.69
23	19.46	20.34	21.23	22.11	23.00	23.88	24.77
24	20.30	21.22	22.16	23.08	24.00	24.91	25.85
25	21.15	22.12	23.08	24.04	25.00	25.95	26.92
26	22.00	23.00	24.00	25.00	26.00	27.00	28.00

TABLE OF WAGES AT GIVEN RATES PER MONTH  
OF TWENTY-SIX DAYS—*continued*

D	\$29	\$30	\$31	\$32	\$35	\$40	\$45
1	1.12	1.15	1.19	1.23	1.35	1.54	1.73
2	2.23	2.30	2.38	2.46	2.69	3.08	3.46
3	3.34	3.46	3.58	3.69	4.04	4.62	5.19
4	4.46	4.62	4.77	4.92	5.38	6.15	6.92
5	5.58	5.77	5.96	6.15	6.73	7.69	8.65
6	6.69	6.92	7.15	7.38	8.07	9.23	10.39
7	7.80	8.08	8.35	8.61	9.42	10.77	12.12
8	8.92	9.23	9.53	9.85	10.77	12.31	13.85
9	10.04	10.38	10.73	11.08	12.11	13.84	15.58
10	11.15	11.54	11.92	12.31	13.46	15.38	17.31
11	12.27	12.69	13.12	13.54	14.81	16.92	19.04
12	13.38	13.85	14.32	14.77	16.15	18.46	20.77
13	14.50	15.00	15.50	16.00	17.50	20.00	22.50
14	15.61	16.15	16.70	17.23	18.84	21.54	24.23
15	16.73	17.31	17.88	18.46	20.19	23.07	25.96
16	17.84	18.46	19.07	19.69	21.54	24.61	27.70
17	18.96	19.62	20.27	20.92	22.88	26.15	29.43
18	20.07	20.77	21.47	22.15	24.23	27.69	31.16
19	21.19	21.92	22.65	23.38	25.57	29.23	33.89
20	22.30	23.08	23.85	24.62	26.92	30.77	34.62
21	23.42	24.23	25.04	25.85	28.27	32.31	36.35
22	24.53	25.38	26.23	27.08	29.61	33.84	38.08
23	25.65	26.54	27.42	28.31	30.96	35.38	39.81
24	26.76	27.69	28.61	29.54	32.31	36.92	41.54
25	27.88	28.85	29.81	30.77	33.65	38.46	43.27
26	29.00	30.00	31.00	32.00	35.00	40.00	45.00

D	\$50	\$60	\$70	\$75	\$80	\$90	\$100
1	1.92	2.31	2.69	2.88	3.08	3.46	3.85
2	3.85	4.62	5.38	5.77	6.15	6.92	7.69
3	5.77	6.92	8.08	8.65	9.23	10.38	11.54
4	7.69	9.23	10.77	11.54	12.31	13.85	15.38
5	9.61	11.54	13.46	14.42	15.38	17.31	19.23
6	11.54	13.85	16.15	17.11	18.46	20.77	23.08
7	13.46	16.15	18.84	19.19	21.54	24.23	26.92
8	15.38	18.46	21.54	23.08	24.62	27.69	30.77
9	17.31	20.77	24.23	25.96	27.69	31.16	34.61
10	19.23	23.08	26.92	28.85	30.77	34.62	38.46
11	21.15	25.38	29.61	31.73	33.84	38.08	42.31
12	23.08	27.69	32.31	34.61	36.92	41.54	46.15
13	25.00	30.00	35.00	37.50	40.00	45.00	50.00
14	26.92	32.31	37.69	40.38	43.08	48.46	53.85
15	28.85	34.61	40.38	43.27	46.15	51.92	57.69
16	30.77	36.92	43.08	46.15	49.23	55.38	61.54
17	32.69	39.23	45.77	49.04	52.31	58.85	65.38
18	34.61	41.54	48.46	51.92	55.38	62.31	69.23
19	36.54	43.84	51.15	54.81	58.46	65.77	73.08
20	38.46	46.15	53.85	57.69	61.54	69.23	76.92
21	40.38	48.46	56.54	60.58	64.61	72.69	80.77
22	42.31	50.77	59.23	63.46	67.69	76.15	84.61
23	44.23	53.08	61.92	66.35	70.77	79.61	88.46
24	46.15	55.38	64.62	69.23	73.85	83.08	92.31
25	48.08	57.69	67.31	72.12	76.92	86.54	96.15
26	50.00	60.00	70.00	75.00	80.00	90.00	100.00

## THE BILTMORE STICK

This implement, employed to ascertain the diameter of standing timber when held at arm's length tangent to the trees to be measured, was briefly described on page 163. Relations between tree, stick, and eye when the stick is in use are made clear in the figure, the circle representing a section of a tree breast high,  $B X$  the Biltmore stick,  $A T$  the distance from the stick to the eye, and  $O M$  a radius vertical to the line of sight passing on one side of the tree. With this for a pattern it is clear how the woodsman, after having determined  $A T$  as a matter of practice, can plot circles of different diameters, draw tangents to them from  $A$ , and ascertain by measurement in each case  $B C$ , the proper stick graduation.

The geometry of the matter is that of similar right-angled triangles, and consideration will show the soundness of the formula appended, from which may be derived

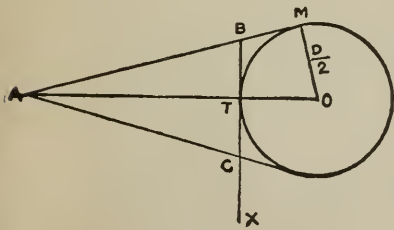

$$BC = \frac{AT \times D}{AT + D}$$

the value of  $BC$  for circles of any size and for any arm reach. When the latter,  $AT$ , has been determined by trial, the formula becomes simpler. Thus with  $AT = 25$  inches

$$BC = \frac{25 D}{\sqrt{25(25 + D)}}$$

$$\text{or, for } D = 10 \text{ inches } \frac{250}{\sqrt{625 + 250}} = \frac{250}{29.58} = 8.45 \text{ inches.}$$

Values of  $BC$  for tree diameters from 6 to 60 inches and distances of 23 to 27 inches have been worked out and are published in the "Proceedings of the Society of American Foresters" for 1914, page 48.

The Forest Service has employed the Biltmore stick in measuring large timber on the Pacific Coast and elsewhere, and the tests applied have shown reasonable accuracy. A careful analysis of sources of error <sup>1</sup> has developed the following:

(a) Tilting the stick and holding it other than vertical to the line of sight to the trees' center are practices to be guarded against, but if reasonable care is used in manipulation, errors are negligible.

(b) In applying values derived from plots or tables to the stick itself, regard must be had to its thickness. The stick may well be beveled, or a steel spline may be inserted into it to carry the graduations.

(c) Errors arising from measuring a tree the narrow or the wide way are greater than with the caliper; hence cross measures are the more desirable.

(d) It is very easy in practice to vary the distance between the stick and the eye, and this introduces error that is material, though in continued work successive errors tend to balance.

(e) Men of ordinary height have a constant tendency to measure tree diameter not breast high, but higher, near the eye level.

To conclude, the Biltmore stick requires to be practically tested before use and constant care in application. More liable to error than the caliper, in ordinary timber it works less rapidly as well. While serviceable in its field, its general use is not to be recommended.

<sup>1</sup> Bruce at previous reference.







